

# Dell Pro Max 14

MC14250

Owner's Manual

## Notes, cautions, and warnings

 **NOTE:** A NOTE indicates important information that helps you make better use of your product.

 **CAUTION:** A CAUTION indicates either potential damage to hardware or loss of data and tells you how to avoid the problem.

 **WARNING:** A WARNING indicates a potential for property damage, personal injury, or death.



<b>Chapter 1: Views of Dell Pro Max 14 MC14250</b>	<b>7</b>
Right	7
Left	7
Top	9
Front	10
Bottom	11
Locate the Service Tag or Express Service Code label of your computer	11
Battery-charge status light	12
<b>Chapter 2: Set up your Dell Pro Max 14 MC14250</b>	<b>13</b>
<b>Chapter 3: Specifications of Dell Pro Max 14 MC14250</b>	<b>15</b>
Dimensions and weight	15
Processor	15
Chipset	16
Operating system	16
Memory	16
External ports and slots	17
Internal slots	17
Ethernet	18
Wireless module	18
Audio	19
Storage	19
Keyboard	19
Keyboard shortcuts of Dell Pro Max 14 MC14250	20
Camera	21
Touchpad	22
Power adapter	23
Power adapter requirements of Dell Pro Max 14 MC14250	23
Battery	24
Power requirements	25
Display	25
Fingerprint reader (optional)	26
Sensor	27
GPU—Integrated	27
Multiple display support matrix	27
Hardware security	27
Smart-card reader	28
Contactless smart-card reader	28
Contacted smart-card reader	31
Operating and storage environment	31
<b>Chapter 4: Working inside your computer</b>	<b>33</b>
Safety instructions	33

Before working inside your computer.....	33
Safety precautions.....	34
Electrostatic discharge—ESD protection.....	34
ESD Field Service kit .....	35
Transporting sensitive components.....	36
After working inside your computer.....	36
BitLocker.....	36
Recommended tools.....	36
Screw list.....	37
Major components of Dell Pro Max 14 MC14250.....	38
<b>Chapter 5: Removing and installing Customer Replaceable Units (CRUs).....</b>	<b>41</b>
Base cover.....	41
Removing the base cover.....	41
Installing the base cover.....	44
Battery.....	46
Rechargeable Li-ion battery precautions.....	46
Removing the battery .....	47
Installing the battery .....	48
Memory module.....	48
Removing the memory module .....	48
Installing the memory module .....	49
Solid State Drive (SSD).....	50
Removing the M.2 2230 solid state drive.....	50
Installing the M.2 2230 solid state drive.....	51
Removing the M.2 2280 solid state drive.....	52
Installing the M.2 2280 solid state drive.....	53
Wireless card.....	54
Removing the wireless card .....	54
Installing the wireless card .....	55
Speakers.....	57
Removing the speakers .....	57
Installing the speakers .....	58
Fan.....	59
Removing the fan .....	59
Installing the fan .....	60
<b>Chapter 6: Removing and installing Field Replaceable Units (FRUs).....</b>	<b>62</b>
Battery cable.....	62
Disconnecting the battery cable .....	62
Connecting the battery cable .....	63
Battery frame.....	64
Removing the battery frame.....	64
Installing the battery frame.....	65
USH board.....	66
Removing the USH board.....	66
Installing the USH board.....	67
Smart-card reader.....	68
Removing the smart-card reader.....	68

Installing the smart-card reader.....	69
Heat sink.....	70
Removing the heat sink .....	70
Installing the heat sink .....	71
I/O board.....	72
Removing the I/O board.....	72
Installing the I/O board.....	73
Power button.....	75
Removing the power button .....	75
Installing the power button .....	76
Display assembly.....	76
Removing the display assembly .....	76
Installing the display assembly .....	79
Display bezel.....	81
Removing the display bezel .....	81
Installing the display bezel .....	86
Display panel.....	87
Removing the display panel .....	87
Installing the display panel .....	90
Display hinges.....	92
Removing the display hinges .....	92
Installing the display hinges .....	94
Display cable.....	95
Removing the display cable .....	95
Installing the display cable .....	96
Camera.....	98
Removing the camera .....	98
Installing the camera .....	99
Display back-cover and antenna assembly.....	100
Removing the display back-cover and antenna assembly .....	100
Installing the display back-cover and antenna assembly .....	101
System board.....	102
Removing the system board .....	102
Installing the system board .....	106
USB Type-C module.....	111
Removing the USB Type-C module.....	111
Installing the USB Type-C module .....	112
Keyboard.....	113
Removing the keyboard.....	113
Installing the keyboard .....	116
Palm-rest assembly.....	118
Removing the palm-rest assembly .....	118
Installing the palm-rest assembly .....	119
<b>Chapter 7: Software.....</b>	<b>121</b>
Operating system.....	121
Drivers and downloads.....	121
<b>Chapter 8: BIOS Setup.....</b>	<b>122</b>

Entering BIOS Setup program.....	122
Navigation keys.....	122
F12 One Time Boot menu.....	122
View Advanced Setup options.....	123
View Service options.....	123
System Setup options.....	123
Updating the BIOS.....	141
Updating the BIOS in Windows.....	141
Updating the BIOS in Linux and Ubuntu.....	142
Updating the BIOS using the USB drive in Windows.....	142
Updating the BIOS from the One-Time boot menu.....	142
System and setup password.....	143
Assigning a System Setup password.....	144
Deleting or changing an existing system password or setup password.....	144
Clearing system and setup passwords.....	144
<b>Chapter 9: Troubleshooting.....</b>	<b>145</b>
Handling swollen rechargeable Li-ion batteries.....	145
Dell SupportAssist Pre-boot System Performance Check diagnostics.....	145
Running the SupportAssist Pre-Boot System Performance Check.....	146
Built-in self-test (BIST).....	146
(Motherboard Built-In Self-Test) M-BIST.....	146
Logic Built-in Self-test (L-BIST).....	147
LCD Built-in Self-Test (LCD-BIST).....	147
System-diagnostic lights.....	147
Recovering the operating system.....	148
Real-Time Clock (RTC Reset).....	149
Backup media and recovery options.....	149
Network power cycle.....	149
Drain flea power (perform hard reset).....	149
<b>Chapter 10: Getting help and contacting Dell.....</b>	<b>151</b>

# Views of Dell Pro Max 14 MC14250

## Right



Figure 1. Right view

### 1. Global headset port

Connect headphones or a headset (headphone and microphone combo).

### 2. USB 3.2 Gen 1 (5 Gbps) port with PowerShare

Connect devices such as external storage devices and printers.

Provides data transfer speeds up to 5 Gbps. PowerShare enables you to charge your USB devices even when your computer is turned off.

**NOTE:** If your computer is turned off or in a hibernation state, you must connect the power adapter to charge your devices using the PowerShare port. You must enable this feature in the BIOS setup program.

**NOTE:** Certain USB devices may not charge when the computer is turned off or in a sleep state. In such cases, turn on the computer to charge the device.

### 3. RJ45 ethernet port (1 Gbps)

Connect an RJ45 ethernet cable from a router or a broadband modem for network or Internet access, with a transfer rate of 10/100/1000 Mbps (maximum 1 Gbps).

### 4. Security-cable slot (wedge-shaped)

Connect a security cable to prevent unauthorized movement of your computer.

## Left

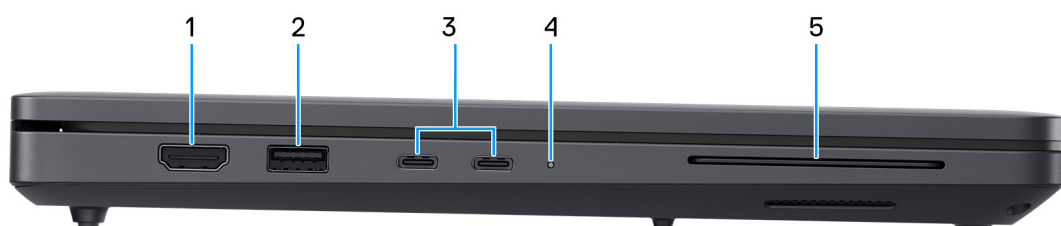


Figure 2. Left view

### 1. **HDMI 2.1 port**

Connect to a TV, external display, or another HDMI-in enabled device. Provides video and audio output.

### 2. **USB 3.2 Gen 1 (5 Gbps) port**

Connect devices such as external storage devices and printers. Provides data transfer speeds up to 5 Gbps.

### 3. **Two Thunderbolt 4 (40 Gbps) ports with Power Delivery and DisplayPort**

Supports USB4, DisplayPort 2.1, Thunderbolt 4 and also enables you to connect to an external display using a display adapter. Provides data transfer rates of up to 40 Gbps for USB4 and Thunderbolt 4.

**NOTE:** The power adapter is to be connected to one of these Thunderbolt 4 ports.

**NOTE:** You can connect a Dell Docking Station to the Thunderbolt 4 ports. For more information, search in the Knowledge Base Resource at [Dell Support Site](#).

**NOTE:** A USB Type-C to DisplayPort adapter (sold separately) is required to connect a DisplayPort device.

**NOTE:** USB4 is backward compatible with USB 3.2, USB 2.0, and Thunderbolt 3.

**NOTE:** Thunderbolt 4 supports two 4K displays or one 8K display.

### 4. **Power and battery-status light**

Indicates the power state and battery state of the computer.

**Solid white**—Power adapter is connected and the battery is charging.

**Solid amber**—Computer is running on battery and the battery charge is low or critical.

**Off**—Power adapter is disconnected or the battery is fully charged.

**NOTE:** On certain computer models, the power and battery-status light are also used for diagnostics. For more information, see the *Troubleshooting* section in this document.

### 5. **Smart-card reader slot (optional)**

Reads information from a smart card with a built-in-chip.

# Top



Figure 3. Top view

## 1. Power button with optional fingerprint reader

Press to turn on the computer if it is turned off, in sleep state, or in hibernate state.

When the computer is turned on, press the power button to put the computer into sleep state; press and hold the power button for ten seconds to force shut-down the computer.

If the power button has a fingerprint reader, place your finger on the power button to log in.

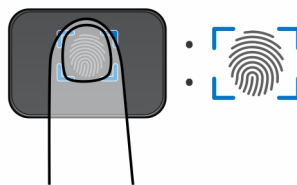


Figure 4. Active area of the fingerprint reader

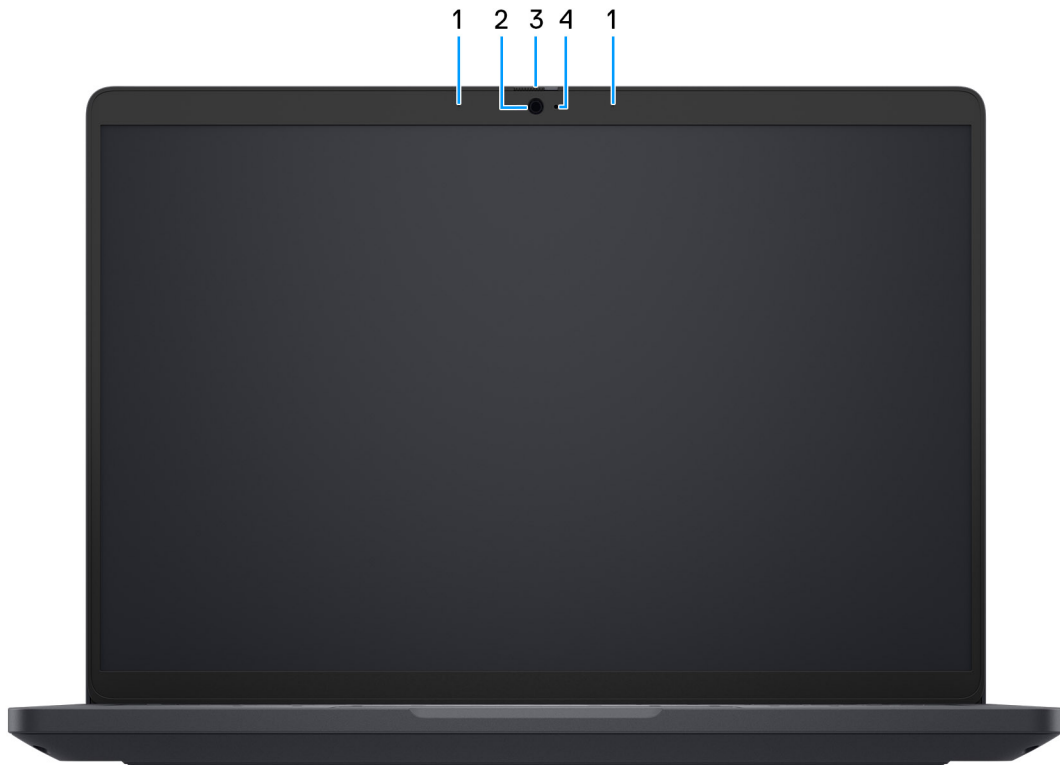
**NOTE:** The highlighted area indicates the actual active fingerprint reader area, and the image is for illustration purposes only.

**NOTE:** You can customize power-button behavior in Windows. For more information, see [Manuals at Dell Support Site](#).

## 2. Precision touchpad

Move your finger on the touchpad to move the mouse pointer. Tap to left-click and two fingers tap to right-click.

# Front



**Figure 5. Front view**

**1. Microphones**

Provide digital sound input for audio recording and voice calls.

**2. Camera**

Enables you to video chat, capture photos, and record videos.

**3. Privacy shutter**

Slide the privacy shutter to cover the camera lens and protect your privacy when the camera is not in use.

**4. Camera-status light**

Turns on when the camera is in use.



# Bottom

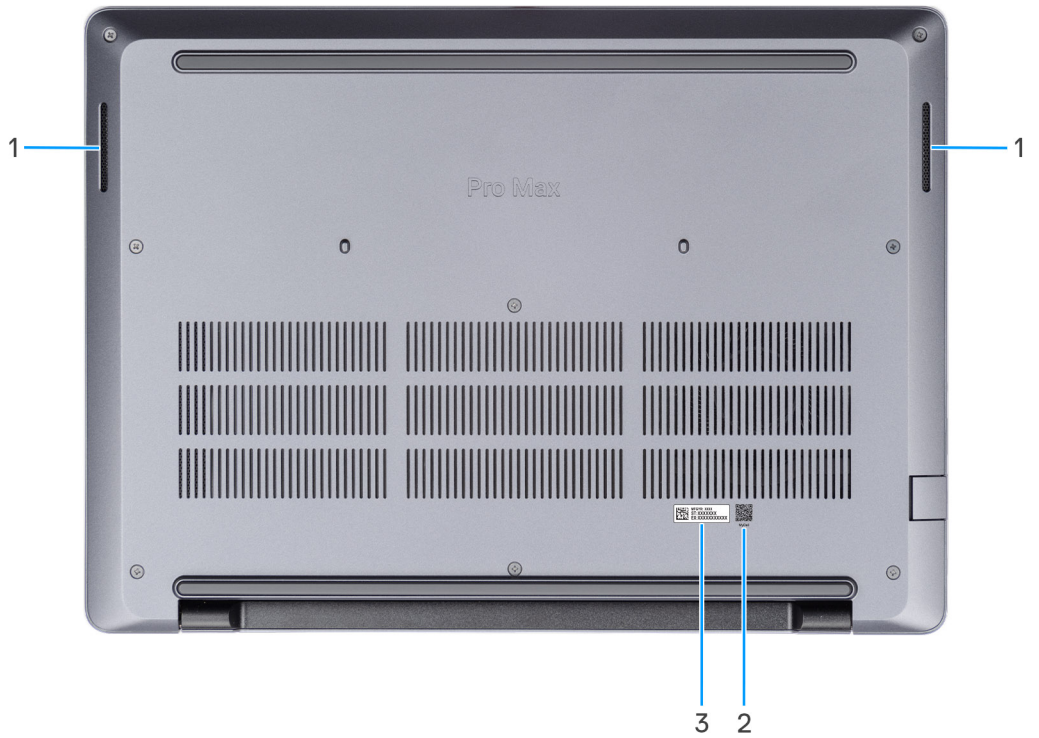


Figure 6. Bottom view

## 1. Speakers

Provide audio output.

## 2. MyDell QR code

MyDell is your hub for content that is personalized for your Dell Pro Max 14 MC14250, including videos, articles, manuals, and access to support.

## 3. Service Tag/Express Service Code label

The Service Tag is a unique alphanumeric identifier that enables Dell service technicians to identify the hardware components in your computer and access warranty information. The Express Service Code is a numeric version of the Service Tag.

# Locate the Service Tag or Express Service Code label of your computer

The Service Tag is a unique alphanumeric identifier that allows Dell service technicians to identify the hardware components in your computer and access warranty information. The Express Service Code is a numeric version of the Service Tag.

For more information about how to find the Service Tag of your computer, search in the Knowledge Base Resource at the [Dell Support Site](#).

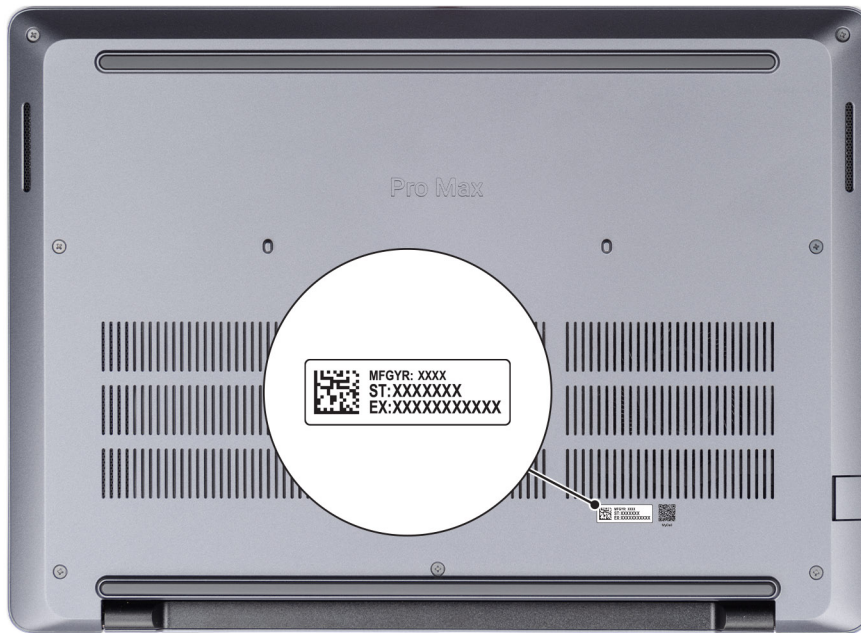


Figure 7. Service Tag/Express Service Code location

## Battery-charge status light

The following table lists the battery-charge status light of your Dell Pro Max 14 MC14250.

Table 1. Battery charge and status light behavior

Power source	LED behavior	System power state	Battery charge level
AC adapter	Off	S0 or S5	Fully charged
AC adapter	Solid white	S0 or S5	< Fully charged
Battery	Off	S0 or S5	11-100%
Battery	Solid amber (590+/-3 nm)	S0 or S5	< 10%

- S0 (ON): Computer is turned on.
- S4 (Hibernate): The computer consumes the least power in the Hibernate state than in the ON or OFF state. The computer is almost in the OFF state. The context data is written to a storage device, allowing you to resume from where you left when the computer is turned on.
- S5 (OFF): The computer is in a shutdown state.

# Set up your Dell Pro Max 14 MC14250

## About this task

**NOTE:** The images in this document may differ from your computer depending on the configuration you ordered.

## Steps

1. Connect the power adapter to one of the Thunderbolt 4 ports and press the power button.



**Figure 8. Connect the power adapter and press the power button**

**NOTE:** The battery may go into power-saving mode during shipment to conserve charge on the battery. Ensure that the power adapter is connected to your computer when it is turned on for the first time.

2. Finish the operating system setup.

### For Ubuntu:

Follow the on-screen instructions to complete the setup. For more information about installing and configuring Ubuntu, search in the Knowledge Base Resource at [Dell Support Site](#).

### For Windows:

Follow the on-screen instructions to complete the setup. When setting up, it is recommended that you:





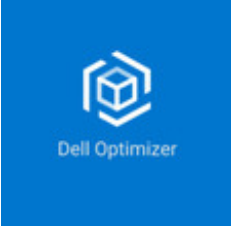
- Connect to a network for Windows updates.

**NOTE:** If connecting to a secured wireless network, enter the password for the wireless network access when prompted.

- If connected to the Internet, sign-in with an existing Microsoft account or create a new account.
- On the **Support and Protection** screen, enter your contact details.

3. Locate and use Dell apps from the Windows Start menu—Recommended.

**Table 2. Locate Dell apps**


Resources	Description
	<p><b>Dell Product Registration</b> Register your computer with Dell.</p>
	<p><b>Dell Help &amp; Support</b> Access help and support for your computer.</p>
	<p><b>SupportAssist</b> SupportAssist keeps your computer running at its best by optimizing settings, detecting issue, and removing viruses. It also notifies when updates are available for your computer. SupportAssist proactively checks the health of your computer hardware and software. When an issue is detected, the necessary system state information is sent to Dell to begin troubleshooting. SupportAssist is preinstalled on most of the Dell devices running the Windows operating system. For more information, see Support Assist documentation at <a href="#">Dell Support Site</a>.</p> <p><b>NOTE:</b> In SupportAssist, click the warranty expiry date to renew or upgrade your warranty.</p>
	<p><b>Dell Update</b> Updates your computer with critical fixes and latest device drivers as they become available. For more information about using Dell Update, see the product guides and third-party license documents at <a href="#">Dell Support Site</a>.</p>
	<p><b>Dell Optimizer</b> Dell Optimizer is an AI-based software application that allows you to customize your computer settings for power and battery, and more.</p> <p>For Dell Pro Max 14 MC14250 with Dell Optimizer, you can:</p> <ul style="list-style-type: none"> <li>• Tune the performance, power consumption, cooling, and fan noise with selectable thermal modes.</li> <li>• Download and redeem the apps that are purchased with your computer.</li> </ul> <p>For more information about configuring and using these features, search for <i>Dell Optimizer</i> at <a href="#">Dell Support Site</a>.</p>

# Specifications of Dell Pro Max 14 MC14250

## Dimensions and weight

The following table lists the height, width, depth, and weight of your Dell Pro Max 14 MC14250.


**Table 3. Dimensions and weight**

Description	Values
Height:	
Front height	14.79 mm (0.58 in.)
Rear height	18.90 mm (0.74 in.)
Width	313 mm (12.32 in.)
Depth	227.30 mm (8.75 in.)
Weight  <b>NOTE:</b> The weight of your computer depends on the configuration that is ordered.	Minimum: 1.83 kg (4.04 lb)

## Processor

The following table lists the details of the processors that are supported by your Dell Pro Max 14 MC14250.

**Table 4. Processor**

Description	Option one	Option two	Option three	Option four
Processor type	Intel Core Ultra 5 225H	Intel Core Ultra 5 235H vPro	Intel Core Ultra 7 255H	Intel Core Ultra 7 265H vPro
Processor wattage	28 W	28 W	28 W	28 W
Processor total core count	14	14	16	16
Performance-cores	4	4	6	6
Efficient-cores	10	10	10	10
Processor total thread count  <b>NOTE:</b> Intel Hyper-Threading Technology is only available on Performance-cores.	14	14	16	16
Processor speed	Up to 4.90 GHz	Up to 5.00 GHz	Up to 5.10 GHz	Up to 5.30 GHz

**Table 4. Processor (continued)**

Description	Option one	Option two	Option three	Option four
Performance-cores frequency				
Processor base frequency	1.70 GHz	2.40 GHz	2.00 GHz	2.20 GHz
Maximum turbo frequency	4.90 GHz	5.00 GHz	5.10 GHz	5.30 GHz
Efficient-cores frequency				
Processor base frequency	1.30 GHz	1.80 GHz	1.50 GHz	1.70 GHz
Maximum turbo frequency	4.30 GHz	4.40 GHz	4.40 GHz	4.50 GHz
Processor cache	18 MB	18 MB	24 MB	24 MB
Integrated graphics	Intel Graphics	Intel Graphics	Intel Graphics	Intel Graphics

## Chipset

The following table lists the details of the chipset that is supported by your Dell Pro Max 14 MC14250.

**Table 5. Chipset**

Description	Values
Chipset	Integrated with the processor
Processor	Intel Core Ultra 5/7 non-vPro/vPro processors
DRAM bus width	64-bit
Flash EPROM	Up to 64 MB
PCIe bus	Up to Gen5

## Operating system

Your Dell Pro Max 14 MC14250 supports the following operating systems:

- Windows 11 Home
- Windows 11 Pro
- Ubuntu Linux 22.04 LTS, 64-bit

## Memory

The following table lists the memory specifications that are supported by your Dell Pro Max 14 MC14250.

**Table 6. Memory specifications**

Description	Values
Memory slots	One LPCAMM2 slot
Memory type	LPDDR5x

**Table 6. Memory specifications (continued)**

Description	Values
Memory speed	7467 MT/s
Maximum memory configuration	64 GB
Minimum memory configuration	16 GB
Memory size per slot	16 GB, 32 GB or 64 GB
Memory configurations supported	<ul style="list-style-type: none"> <li>• 16 GB: 1 x 16 GB, LPCAMM LPDDR5x, 7467 MT/s, dual-channel</li> <li>• 32 GB: 1 x 32 GB, LPCAMM LPDDR5x, 7467 MT/s, dual-channel</li> <li>• 64 GB: 1 x 64 GB, LPCAMM LPDDR5x, 7467 MT/s, dual-channel</li> </ul>

## External ports and slots

The following table lists the external ports and slots of your Dell Pro Max 14 MC14250.

**Table 7. External ports and slots**

Description	Values
Network port	One RJ45 ethernet port (1 Gbps)
USB ports	<ul style="list-style-type: none"> <li>• Two Thunderbolt 4 (40 Gbps) ports with Power Delivery and DisplayPort</li> <li>• One USB 3.2 Gen 1 (5 Gbps) port with PowerShare</li> <li>• One USB 3.2 Gen 1 (5 Gbps) port</li> </ul>
Audio port	One global headset port
Video port(s)	<ul style="list-style-type: none"> <li>• Two Thunderbolt 4 (40 Gbps) ports with Power Delivery and DisplayPort</li> <li>• One HDMI 2.1 port</li> </ul>
Media-card reader	One optional smart-card reader slot
Power-adaptor port	Supported via two Thunderbolt 4 (40 Gbps) ports with Power Delivery and DisplayPort
Security-cable slot	One wedge-shaped lock slot


## Internal slots

The following table lists the internal slots of your Dell Pro Max 14 MC14250.

**Table 8. Internal slots**

Description	Values
M.2	<ul style="list-style-type: none"> <li>• One M.2 Key-M (2230/2280) slot for solid-state drive</li> <li>• One M.2 2230 Key-E slot for Wi-Fi and Bluetooth combo card</li> </ul>

**Table 8. Internal slots**

Description	Values
	 <b>NOTE:</b> To learn more about the features of different types of M.2 cards, search in the Knowledge Base Resource at <a href="#">Dell Support Site</a> .

## Ethernet

The following table lists the wired Ethernet Local Area Network (LAN) specifications of your Dell Pro Max 14 MC14250.


**Table 9. Ethernet specifications**

Description	Values
Model	<ul style="list-style-type: none"> <li>Intel I219-LM for vPro configurations</li> <li>Intel I219-V for non-vPro configurations</li> </ul>
Transfer rate	10/100/1000 Mbps

## Wireless module

The following table lists the Wireless Local Area Network (WLAN) modules that are supported on your Dell Pro Max 14 MC14250.

**Table 10. Wireless module specifications**

Description	Option one	Option two
Model number	Intel Wi-Fi 6E AX211	Intel Wi-Fi 7 BE201
Transfer rate	Up to 2400 Mbps	Up to 5760 Mbps
Frequency bands supported	2.4 GHz/5 GHz/6 GHz	2.4 GHz/5 GHz/6 GHz
Wireless standards	<ul style="list-style-type: none"> <li>Wi-Fi 802.11 a/b/g</li> <li>Wi-Fi 4 (WiFi 802.11n)</li> <li>Wi-Fi 5 (WiFi 802.11ac)</li> <li>Wi-Fi 6E (WiFi 802.11ax)</li> </ul>	<ul style="list-style-type: none"> <li>Wi-Fi 802.11 a/b/g</li> <li>Wi-Fi 4 (WiFi 802.11n)</li> <li>Wi-Fi 5 (WiFi 802.11ac)</li> <li>Wi-Fi 6E (WiFi 802.11ax)</li> <li>Wi-Fi 7 (WiFi 802.11be)</li> </ul>
Encryption	<ul style="list-style-type: none"> <li>64-bit/128-bit WEP</li> <li>AES-CCMP</li> <li>TKIP</li> </ul>	<ul style="list-style-type: none"> <li>64-bit/128-bit WEP</li> <li>AES-CCMP</li> <li>TKIP</li> </ul>
Bluetooth wireless card	Bluetooth 5.3	Bluetooth 5.4
	 <b>NOTE:</b> The functionality of the Bluetooth wireless card may vary depending on the operating system that is installed on your computer.	



# Audio

The following table lists the audio specifications of your Dell Pro Max 14 MC14250.

**Table 11. Audio specifications**

Description		Values
Audio controller		Realtek ALC3329
Stereo conversion		Supported with Waves MaxxAudio Pro
Internal audio interface		Soundwire interface
External audio interface		One global headset port
Number of speakers		Two
Internal-speaker amplifier		Supported via Realtek ALC1708
External volume controls		Keyboard shortcut controls
Speaker output:		
	Average	2 W x 2 = 4 W
	Peak	2.5 W x 2 = 5 W
Microphone		Dual-array digital microphones

# Storage

This section lists the storage options on your Dell Pro Max 14 MC14250.

Your Dell Pro Max 14 MC14250 supports one M.2 2230/2280 solid state drive. The M.2 2230/2280 solid state drive is the primary storage drive of your computer.

**Table 12. Storage specifications**

Storage type	Interface type	Capacity
M.2 2230 solid state drive	Gen 4 x4 PCIe NVMe	256 GB or 512 GB
M.2 2280 solid state drive, Self-Encrypting	Gen 4 x4 PCIe NVMe	1 TB or 2 TB

# Keyboard

The following table lists the keyboard specifications of your Dell Pro Max 14 MC14250.

**Table 13. Keyboard specifications**

Description	Values
Keyboard type	<ul style="list-style-type: none"> <li>• Magnetite, Standard AI hotkey backlit keyboard</li> <li>• Magnetite, Standard AI hotkey non-backlit keyboard</li> </ul>
Keyboard layout	QWERTY

**Table 13. Keyboard specifications (continued)**

Description	Values
Number of keys	<ul style="list-style-type: none"> <li>• United States and Canada: 79 keys</li> <li>• United Kingdom: 80 keys</li> <li>• Japan: 83 keys</li> </ul>
Keyboard size	X = 19.05 mm key pitch Y = 18.05 mm key pitch
Keyboard shortcuts	<p>Some keys on your keyboard have two symbols on them. These keys can be used to type alternate characters or to perform secondary functions. To type the alternate character, press Shift and the desired key. To perform secondary functions, press Fn and the desired key.</p> <p><b>i</b> <b>NOTE:</b> You can define the primary behavior of the function keys (F1–F12) changing <b>Function Key Behavior</b> in the BIOS setup program.</p> <p><b>i</b> <b>NOTE:</b> If Copilot in Windows is not available on your computer, pressing the Copilot key launches Windows search. For more information about Copilot in Windows, search in the Knowledge Base Resource at the <a href="#">Dell Support site</a>.</p>

## Keyboard shortcuts of Dell Pro Max 14 MC14250

**i** **NOTE:** Keyboard characters may differ depending on the keyboard language configuration. Keys that are used for shortcuts remain the same across all language configurations.

Some keys on your keyboard have two symbols on them. These keys can be used to type alternate characters or to perform secondary functions. The symbol that is shown on the lower part of the key refers to the character that is typed out when the key is pressed. If you press shift and the key, the symbol that is shown on the upper part of the key is typed out. For example, if you press **2**, 2 is typed out; if you press **Shift + 2**, @ is typed out.

The keys F1-F12 at the top row of the keyboard are function keys for multimedia control, as indicated by the icon on the key. Press the function key to enable the task represented by the icon. For example, pressing F1 mutes the audio (see the table below).

However, if the function keys F1-F12 are needed for specific software applications, multimedia functionality can be disabled by pressing **Fn + Esc**. Later, multimedia control can be invoked by pressing **Fn** and the respective function key. For example, mute audio by pressing **Fn + F1**.

**i** **NOTE:** You can also define the primary behavior of the function keys (F1–F12) by changing **Function Key Behavior** in the BIOS setup program.

**Table 14. Function key primary behavior**

Function key	Primary behavior
F1	Mute or unmute audio
F2	Decrease volume
F3	Increase volume
F4	Microphone Mute
F5	Keyboard Illumination/Backlight
F6	Decrease brightness
F7	Increase brightness
F8	Switch to external display

**Table 14. Function key primary behavior (continued)**

Function key	Primary behavior
F10	Print screen
F11	Home
F12	End

The **Fn** key is also used with selected keys on the keyboard to invoke secondary functions.

**Table 15. Secondary behavior**

Function key	Secondary behavior
Fn + F1	Operating system and application-specific F1 behavior
Fn + F2	Operating system and application-specific F2 behavior
Fn + F3	Operating system and application-specific F3 behavior
Fn + F4	Operating system and application-specific F4 behavior
Fn + F5	Operating system and application-specific F5 behavior
Fn + F6	Operating system and application-specific F6 behavior
Fn + F7	Operating system and application-specific F6 behavior
Fn + F8	Operating system and application-specific F8 behavior
Fn + F9	Operating system and application-specific F9 behavior
Fn + F10	Operating system and application-specific F10 behavior
Fn + F11	Operating system and application-specific F11 behavior
Fn + F12	Operating system and application-specific F12 behavior
Fn + Ctrl	Open the application menu
Fn + Esc	Toggle between multimedia and function key behavior
Fn + PgUp	Scroll up the document or page
Fn + PgDn	Scroll down the document or page
Fn + Home	Move to the beginning of the document
Fn + End	Move to the end of the document
Copilot	Launch Copilot in Windows <b>NOTE:</b> If Copilot in Windows is not available on your computer, the Copilot key launches Recall. If both Recall and Copilot in Windows are not available on your computer, the Copilot key launches Windows Search. For more information about Copilot in Windows and Recall, search in the Knowledge Base Resource at the <a href="#">Dell Support Site</a> .

## Camera

The following table lists the camera specifications of your Dell Pro Max 14 MC14250.

**Table 16. Camera specifications**

Description	Option one	Option two
Number of cameras	One	Two

**Table 16. Camera specifications (continued)**

Description		Option one	Option two
Camera type		FHD RGB camera	FHD RGB and IR camera
Camera location		Front camera	Front camera
Camera sensor type		CMOS sensor technology	CMOS sensor technology
Camera resolution:			
	Still image	2.07 megapixel	2.07 megapixel
	Video	1920 x 1080 (FHD) at 30 fps	1920 x 1080 (FHD) at 30 fps
Infrared camera resolution:			
	Still image	N/A	0.23 megapixel
	Video	N/A	640 x 360 at 15 fps
Diagonal viewing angle:			
	Camera	80.20 degrees	80.20 degrees
	Infrared camera	N/A	86.60 degrees

## Touchpad

The following table lists the touchpad specifications of your Dell Pro Max 14 MC14250.


**Table 17. Touchpad specifications**

Description		Values
Touchpad resolution:		
	Horizontal	>= 300 dpi
	Vertical	>= 300 dpi
Touchpad dimensions:		
	Horizontal	125 mm (4.92 in.)
	Vertical	73 mm (2.87 in.)
Touchpad gestures		<p>For more information about the touchpad gestures that are available on:</p> <ul style="list-style-type: none"> <li>Windows, see the Microsoft Knowledge Base article at <a href="#">Microsoft Support Site</a>.</li> <li>Ubuntu, see <a href="#">Ubuntu Support Site</a>.</li> </ul>

# Power adapter

The following table lists the power adapter specifications of your Dell Pro Max 14 MC14250.

**Table 18. Power-adapter specifications**

Description	Option one	Option two
Type	100 W AC adapter, USB Type-C	130 W AC adapter, USB Type-C
Power-adapter dimensions:		
Height	26.50 mm (1.04 in.)	22 mm (0.87 in.)
Width	60 mm (2.36 in.)	66 mm (2.60 in.)
Depth	122 mm (4.80 in.)	143 mm (5.63 in.)
Input voltage	100 VAC - 240 VAC	100 VAC - 240 VAC
Input frequency	50 Hz - 60 Hz	50 Hz - 60 Hz
Input current (maximum)	1.70 A	1.80 A
Output current (continuous)	<ul style="list-style-type: none"> <li>● 20 V/5 A</li> <li>● 15 V/3 A</li> <li>● 9 V/3 A</li> <li>● 5 V/3 A</li> </ul>	<ul style="list-style-type: none"> <li>● 20 V/6.50 A</li> <li>● 5 V/1 A</li> </ul>
Rated output voltage	<ul style="list-style-type: none"> <li>● 20 VDC</li> <li>● 15 VDC</li> <li>● 9 VDC</li> <li>● 5 VDC</li> </ul>	<ul style="list-style-type: none"> <li>● 20 VDC</li> <li>● 5 VDC</li> </ul>
Temperature range:		
Operating	0°C to 40°C (32°F to 104°F)	0°C to 40°C (32°F to 104°F)
Storage	-40°C to 70°C (-40°F to 158°F)	-40°C to 70°C (-40°F to 158°F)
 <b>CAUTION: Operating and storage temperature ranges may differ among components, so operating or storing the device outside these ranges may impact the performance of specific components.</b>		

## Power adapter requirements of Dell Pro Max 14 MC14250

**NOTE:** If you did not purchase the Dell-branded power adapter that is recommended for your computer, ensure that the power adapter you use meets the following requirements.

The following table lists the power adapter requirements for your Dell Pro Max 14 MC14250.

**Table 19. Power adapter requirements**

Description	Value
Power that is required from a power adapter to achieve optimal performance	100 W
Power that charges the computer at a slower speed	Less than 60 W

**Table 19. Power adapter requirements (continued)**

Description	Value
<p><b>i</b> <b>NOTE:</b> A warning message may appear informing you about the use of a lower-powered adapter and slower charging speed.</p>	
<p>Minimum power that is required from a power adapter to operate the computer and charge the battery</p> <p><b>i</b> <b>NOTE:</b> A warning message appears informing you about the use of a lower-powered adapter and slower charging speed.</p>	45 W
USB Power Delivery (PD) fast charging	Supported
ExpressCharge mode	<p>Supported</p> <p><b>i</b> <b>NOTE:</b> Ensure that the computer with a 72 Wh battery is connected to a 100 W power adapter for this feature to be supported.</p> <p><b>i</b> <b>NOTE:</b> ExpressCharge mode must also be enabled in the BIOS Setup screen. Select <b>Power &gt; Battery Configuration &gt; ExpressCharge</b>, then press <b>Enter</b>.</p>

## Battery

The following table lists the battery specifications of your Dell Pro Max 14 MC14250.

**Table 20. Battery specifications**

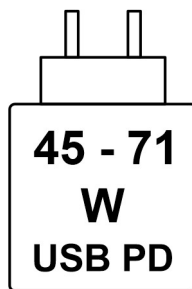
Description	Option one	Option two
Battery type	4-cell, 72 Wh, Lithium Ion Polymer, Standard Life, ExpressCharge, ExpressCharge Boost	4-cell, 72 Wh, Lithium Ion Polymer, Long Cycle Life, ExpressCharge, ExpressCharge Boost
Battery voltage	15.60 VDC	15.60 VDC
Battery weight (maximum)	0.27 kg (0.60 lb)	0.27 kg (0.60 lb)
Battery dimensions:		
	Height	7.64 mm (0.30 in.)
	Width	266.62 mm (10.45 in.)
	Depth	72.68 mm (2.86 in.)
Temperature range:		
	Operating	<ul style="list-style-type: none"> <li>Charge: 0°C to 50°C (32°F to 122°F)</li> <li>Discharge: 0°C to 60°C (32°F to 140°F)</li> </ul>
	Storage	-20°C to 65°C (-4°F to 149°F)
Battery operating time	Varies depending on operating conditions and can significantly reduce under certain power-intensive conditions.	Varies depending on operating conditions and can significantly reduce under certain power-intensive conditions.

**Table 20. Battery specifications (continued)**

Description	Option one	Option two
Battery charging time (approximate) <b>i</b> <b>NOTE:</b> You can control the charging time, duration, start and end time, and so on, using the Dell Power Manager application. For more information about Dell Power Manager, search in the Knowledge Base Resource at <a href="#">Dell Support Site</a> .	<ul style="list-style-type: none"> <li>ExpressCharge Boost - From 0% to 35% in almost 20 minutes</li> <li>ExpressCharge - 2 hours</li> <li>Standard charge - 3 hours</li> </ul>	<ul style="list-style-type: none"> <li>ExpressCharge Boost - From 0% to 35% in almost 20 minutes</li> <li>ExpressCharge - 2 hours</li> <li>Standard charge - 3 hours</li> </ul>
Coin-cell battery	Not supported	Not supported
<b>⚠ CAUTION: Operating and storage temperature ranges may differ among components, so operating or storing the device outside these ranges may impact the performance of specific components.</b> <b>⚠ CAUTION: Dell Technologies recommends that you charge the battery regularly for optimal power consumption.</b>		

## Power requirements

**i** **NOTE:** The information in this section is applicable to the European Union (EU) countries.



**Figure 9. Pictogram for 72 Wh battery**

The power that is delivered by the charger must be between a minimum of 45 Watts that is required by the radio equipment, and a maximum of 71 Watts in order to achieve the maximum charging speed.

This computer supports USB Power Delivery (PD) fast charging.

## Display

The following table lists the display specifications of your Dell Pro Max 14 MC14250.

**Table 21. Display specifications**


Description	Option one	Option two
Display type	14" Full High Definition Plus (FHD+)	14" Full High Definition Plus (FHD+)
Touch options	Not supported	Supported
Display-panel technology	Wide-Viewing Angle (WVA)	Wide-Viewing Angle (WVA)
Display-panel dimensions (active area):		
Height	188.50 mm (7.42 in.)	188.50 mm (7.42 in.)

**Table 21. Display specifications (continued)**

Description		Option one	Option two
	Width	301.59 mm (11.87 in.)	301.59 mm (11.87 in.)
	Diagonal	355.65 mm (14 in.)	355.65 mm (14 in.)
Display-panel native resolution		1920 x 1200	1920 x 1200
Luminance (typical)		300 nits	300 nits
Megapixels		2.3	2.3
Color gamut		45% NTSC	100% sRGB
Pixels Per Inch (PPI)		162	162
Contrast ratio (minimum)		800:1	800:1
Response time (maximum)		35 ms	35 ms
Refresh rate		60 Hz	60 Hz
Horizontal view angle		<ul style="list-style-type: none"> <li>• Minimum: 80 +/- degrees</li> <li>• Typical: 85 +/- degrees</li> </ul>	<ul style="list-style-type: none"> <li>• Minimum: 80 +/- degrees</li> <li>• Typical: 85 +/- degrees</li> </ul>
Vertical view angle		<ul style="list-style-type: none"> <li>• Minimum: 80 +/- degrees</li> <li>• Typical: 85 +/- degrees</li> </ul>	<ul style="list-style-type: none"> <li>• Minimum: 80 +/- degrees</li> <li>• Typical: 85 +/- degrees</li> </ul>
Pixel pitch		0.157 x 0.157	0.157 x 0.157
Power consumption (maximum)		3.68 W	4.4 W
Anti-glare vs glossy finish		Anti-glare	Anti-glare

## Fingerprint reader (optional)

The following table lists the specifications of the optional fingerprint reader of your Dell Pro Max 14 MC14250.

 **NOTE:** The fingerprint reader is on the power button.

**Table 22. Fingerprint reader specifications**

Description	Values
Sensor technology	Capacitive sensing
Sensor resolution	500 dpi
Sensor pixel size	108 x 88 pixels



# Sensor

The following table lists the sensor of your Dell Pro Max 14 MC14250.

**Table 23. Sensor**

Sensor support
Accelerometer (for positional sensing)
Hall Effect Sensor

# GPU—Integrated

The following table lists the specifications of the integrated Graphics Processing Unit (GPU) supported by your Dell Pro Max 14 MC14250.

**Table 24. GPU—Integrated**

Controller	Memory size	Processor
Intel Graphics	Shared system memory	Intel Core Ultra 5/7 non-vPro/vPro processors

# Multiple display support matrix

The following table lists the multiple display support matrix for your Dell Pro Max 14 MC14250.

**Table 25. Multiple display support matrix**

Graphics Card	Direct Graphics Controller Direct Output Mode	Supported external displays with computer internal display on	Supported external displays with computer internal display off
Intel Graphics	Not supported	3	4

# Hardware security

The following table lists the hardware security of your Dell Pro Max 14 MC14250.

**Table 26. Hardware security**

Hardware security
One wedge-shaped lock slot
Windows Hello - Fingerprint Reader (optional)
Trusted Platform Module (TPM) 2.0 discrete
FIPS 140-2 certification for TPM
TCG Certification for TPM (Trusted Computing Group)
Finger Print Reader in Power Button available with and without ControlVault 3 Plus
ControlVault 3 Plus Advanced Authentication with FIPS 140-3 Level 3 Certification
Contacted Smart Card and ControlVault 3 Plus
Contactless Smart Card, NFC, and ControlVault 3 Plus
SED SSD NVMe, SSD per SDL


# Smart-card reader

## Contactless smart-card reader

This section lists the contactless smart-card reader specifications of your Dell Pro Max 14 MC14250. This module is only available in computers shipped with Smart-card readers.

**Table 27. Contactless smart-card reader specifications**

Title	Description	Dell ControlVault 3 Plus Contactless smart-card reader with NFC
Felica Card Support	Reader and software capable of supporting Felica contactless cards	Yes
Prox (Proximity) (125kHz) Card support	Reader and software capable of supporting Prox /Proximity/125 kHz contactless cards	No
ISO 14443 Type A Card Support	Reader and software capable of supporting ISO 14443 Type A contactless cards	Yes
ISO 14443 Type B Card Support	Reader and software capable of supporting ISO 14443 Type B contactless cards	Yes
ISO/IEC 21481	Reader and software capable of supporting ISO/IEC 21481 compliant contactless cards and tokens	Yes
ISO/IEC 18092	Reader and software capable of supporting ISO/IEC 21481 compliant contactless cards and tokens	Yes
ISO 15693 Card Support	Reader and software capable of supporting ISO15693 contactless cards	Yes
NFC Tag Support	Supports reading and processing of NFC compliant tag information	Yes
NFC Reader Mode	Support for NFC Forum Defined Reader mode	Yes
NFC Writer Mode	Support for NFC Forum Defined Writer mode	Yes
NFC Peer-to-Peer Mode	Support for NFC Forum Defined Peer to Peer mode	Yes
NFC Proximity OS Interface	Enumerates NFP (Near Field Proximity) device for operating system to utilize	Yes
PC/SC operating system interface	Personal Computer/Smart Card specification for integration of hardware readers into personal computer environments	Yes
CCID driver compliance	Common driver support for Integrated Circuit Card Interface Device for operating system level drivers	Yes
Dell ControlVault support	The device connects to Dell ControlVault for usage and processing	Yes

 **NOTE:** 125 KHz proximity cards are not supported.

**Table 28. Supported contactless smart-card types**

Interface	Card type	Supported functionality
NFC Forum (Microsoft Proximity Device)	Type 1 tag	Read/Write NDEF
	Type 2 tag	Read/Write NDEF
	Type 3 tag	Read/Write NDEF
	Type 4 tag	Read/Write NDEF
	Type 5 tag	Read/Write NDEF
	P2P	Exchange NDEF
RFID (Microsoft Smartcard Device)	ISO14443A	Read UUID and APDU Exchange (ISO7816)
	ISO14443B	Read UUID and APDU Exchange (ISO7816)
	Sony FeliCa	Read UUID only
	Legacy iClass (ISO15693)	Read UUID only
	Mifare Classic	Read UUID only
	Low Frequency (125 KHz )	Not supported

**Table 29. Supported cards**

Manufacturer	Card
HID	jCOP readertest3 A card (14443a)
	1430 1L
	DESFire D8H
	DESFIRE 4K Standard - 1450NGGNN
	iClass 16K/16 - 2002PGGMN
	iClass SR 16K/16 - 2002HPGGMN
	iCLASS 2K tag
	iCLASS GP - 2003 PGGMN
	iClass Clamshell - 2080PMSMV
	iClass Prox 16K/16 - 2022BGGMNN
	Mifare M1P 1430 NGGNN
	iclass Prox 2020BGGMNM
	DesFire D8P 1456CSGMN
	iCLASS MIFARE Px GM49Y 2623BNPGGBNAB
	iCLASS MIFARE Px 8M1L
	iClass SEOS JW 5006PGGMN
	Crescendo iCLASS Px G8H
	iCLASS Seos IY
	SEOS JMC4 J1Y 5806VNG1NNN4
	SEOS Key FOB 5266PNNA
SEOS Clamshell 5656PMSAV	
SEOS + Prox 5106RGGMNN	

**Table 29. Supported cards (continued)**

Manufacturer	Card
	SEOS + DESFire 5906PNG1ANN7
	SEOS iClass 5006PGGMN7
	Seos Essential + Prox 551PPGGANN
	iCLASS 2K 2000PGGMN
	iCLASS 2K 3000PGGMN
	MIFARE DESFire 3700CPGGAN
	iCLASS DP
	DESFire 1Y
NXP/Mifare	Mifare DESFire 8K White PVC card
	Mifare Classic 1K White PVC card
	NXP Mifare Classic S50 ISO card
	Mifare DESFire 2K
	Mifare Plus S 2K/4K
	Mifare Plus X 4K
G&D	idOnDemand - SCE3.2 144K
	SCE6.0 FIPS 80K Dual + 1K Mifare
	SCE6.0 nonFIPS 80K Dual + 1K Mifare
	SCE6.0 FIPS 144K Dual + 1K Mifare
	SCE6.0 nonFIPS 144K Dual + 1K Mifare
	SCE7.0 FIPS 144K
Oberthur	idOnDemand - OCS5.2 80K
	ID-One Cosmo 64 RSA D V5.4 T = 0 card
	ID-One Cosmo 128K V5.5 card
Gemalto	TOP DL GX4 144K card
Sony	Felica RC-S962
	Felica RC-S965
	Felica RC-S966
PIVKey	C910 PKI
NIST	PIV1
IDENTIV	PIV programmed cards
	uTrust
Transport cards	Oyster (London) MIFARE DESFire
	T-Money (Korea)
	Octopus Card (Hong Kong)
	SUICA (Japan)

## Contacted smart-card reader

The following table lists the contacted smart-card reader specifications of your Dell Pro Max 14 MC14250.

**Table 30. Contacted smart-card reader specifications**

Title	Description	Dell ControlVault 3 smart-card reader
ISO 7816 -3 Class A Card Support	Reader capable of reading 5V powered smart mcard	Yes
ISO 7816 -3 Class B Card Support	Reader capable of reading 3V powered smart card	Yes
ISO 7816 -3 Class C Card support	Reader capable of reading 1.8V powered smart card	Yes
ISO 7816-1 Compliant	Specification for the reader	Yes
ISO 7816 -2 Compliant	Specification for smart card device physical characteristics (size, location of connection points, etc.)	Yes
T=0 support	Cards support character level transmission	Yes
T=1 support	Cards support block level transmission	Yes
EMVCo Compliant	Compliant with EMVCo (for electronic payment standards) smart card standards as posted to <a href="http://www.emvco.com">www.emvco.com</a>	Yes
EMVCo Certified	Formally certified based on EMVCO smart card standards	Yes
PC/SC OS interface	Personal Computer/Smart Card specification for integration of hardware readers into personal computer environments	Yes
CCID driver compliance	Common driver support for Integrated Circuit Card Interface Device for OS level drivers.	Yes
Windows Certified	Device certified by WHCK	Yes
FIPS 201 (PIV/HSPD-12) Compliant via GSA	Device compliant with FIPS 201/PIV/HSPD-12 requirements	Yes
FIDO2 compliance	Dell ControlVault 3 Smart-card reader is compliant with the FIDO SPEC	Yes

## Operating and storage environment


This table lists the operating and storage specifications of your Dell Pro Max 14 MC14250.

**Airborne contaminant level:** G1 as defined by ISA-S71.04-1985

**Table 31. Computer environment**

Description	Operating	Storage
Temperature range	0°C to 35°C (32°F to 95°F)	-40°C to 65°C (-40°F to 149°F)
Relative humidity (maximum)	10% to 90% (non-condensing)	0% to 95% (non-condensing)
Vibration (maximum)*	0.66 GRMS	1.30 GRMS

**Table 31. Computer environment (continued)**

Description	Operating	Storage
Shock (maximum)	110 G†	160 G†
Altitude range	-15.2 m to 3048 m (-49.87 ft to 10,000 ft)	-15.2 m to 10,668 m (-49.87 ft to 35,000 ft)
 <b>CAUTION: Operating and storage temperature ranges may differ among components, so operating or storing the device outside these ranges may impact the performance of specific components.</b>		










\* Measured using a random vibration spectrum that simulates the user environment.

† Measured using a 2 ms half-sine pulse.

# Working inside your computer



## Safety instructions

Use the following safety guidelines to protect your computer from potential damage and to ensure your personal safety. Unless otherwise noted, each procedure in this document assumes that you have read the safety information that shipped with your computer.

-  **WARNING:** Before working inside your computer, read the safety information that is shipped with your computer. For more safety best practices, see [Dell Regulatory Compliance Home Page](#).
-  **WARNING:** Disconnect your computer from all power sources before opening the computer cover or panels. After you finish working inside the computer, replace all covers, panels, and screws before connecting your computer to an electrical outlet.
-  **CAUTION:** To avoid damaging the computer, ensure that the work surface is flat, dry, and clean.
-  **CAUTION:** You should only perform troubleshooting and repairs as authorized or directed by the Dell technical support team. Damage due to servicing that is not authorized by Dell is not covered by your warranty. See the safety instructions that are shipped with the product or at [Dell Regulatory Compliance Home Page](#).
-  **CAUTION:** Before touching anything inside your computer, ground yourself by touching an unpainted metal surface, such as the metal at the back of the computer. While you work, periodically touch an unpainted metal surface to dissipate static electricity which could harm internal components.
-  **CAUTION:** To avoid damaging the components and cards, handle them by their edges, and avoid touching the pins and the contacts.
-  **CAUTION:** When you disconnect a cable, pull it by its connector or its pull tab, not the cable itself. Some cables have connectors with locking tabs or thumbscrews that you must disengage before disconnecting the cable. When disconnecting cables, keep them evenly aligned to avoid bending the connector pins. When connecting cables, ensure that the connector on the cable is correctly oriented and aligned with the port.
-  **CAUTION:** Press and eject any installed card from the media-card reader.
-  **CAUTION:** Exercise caution when handling rechargeable Li-ion batteries in laptops. Swollen batteries should not be used and should be replaced and disposed properly.

## Before working inside your computer

### Steps


1. Save and close all open files and exit all open applications.
2. Shut down your computer. For Windows operating system, click **Start** >  **Power** > **Shut down**.
  -  **NOTE:** If you are using a different operating system, see the documentation of your operating system for instructions.
3. Turn off all the attached peripherals.
4. Disconnect your computer from the electrical outlet.
5. Disconnect all attached network devices and peripherals, such as keyboard, mouse, and monitor from your computer.
6. Remove any media card and optical drive from your computer, if applicable.
7. To clean the air vents, use a soft brush and move vertically.


 **NOTE:** Do not remove the base cover or use any blower to clean the vents.

8. Enter the Service Mode.

#### Service Mode

Service Mode is used to cut off power without disconnecting the battery cable from the system board before conducting repairs in the computer.

 **CAUTION:** If you are unable to turn on the computer to put it into Service Mode, proceed to disconnect the battery cable. To disconnect the battery cable, follow the steps in [Removing the battery](#).

 **NOTE:** Ensure that your computer is shut down and the power adapter is disconnected.

- a. Press and hold the B key and the power button for 3 seconds or until the Dell logo appears on the screen.
- b. Press any key to continue.
- c. If the power adapter is not disconnected, a message prompting you to disconnect the power adapter appears on the screen. Disconnect the power adapter and then press any key to enter into the Service Mode. The Service Mode process automatically skips the following step if the **Owner Tag** of the computer is not set up in advance by the user.
- d. When the **ready-to-proceed** message appears on the screen, press any key to proceed. The computer emits three short beeps and shuts down immediately.  
The computer shuts down and enters the Service Mode.

## Safety precautions

This section details the primary steps to be followed before disassembling any device or component.

Observe the following safety precautions before any installation or break-fix procedures involving disassembly or reassembly:

- Turn off the computer and all attached peripherals.
- Disconnect the computer from AC power.
- Disconnect all network cables and peripherals from the computer.
- Use an ESD field service kit when working inside your computer to avoid electrostatic discharge (ESD) damage.
- Place the removed component on an anti-static mat after removing it from the computer.
- Wear shoes with nonconductive rubber soles to reduce the chance of getting electrocuted.
- Press and hold the power button for 15 seconds to discharge the residual power in the system board.

## Standby power

Dell products with standby power must be unplugged before you open the back cover. Systems that are equipped with standby power are powered while turned off. The internal power enables the computer to be remotely turned on (Wake-on-LAN) and suspended into a sleep mode and has other advanced power management features.

## Bonding

Bonding is a method for connecting two or more grounding conductors to the same electrical potential. This is done by using a field service electrostatic discharge (ESD) kit. When connecting a bonding wire, ensure that it is connected to bare metal and never to a painted or nonmetal surface. Ensure that the wrist strap is secure and in full contact with your skin. Remove all jewelry, watches, bracelets, or rings before grounding yourself and the equipment.

## Electrostatic discharge—ESD protection

ESD is a major concern when you handle electronic components, especially sensitive components such as expansion cards, processors, memory modules, and system boards. A slight charge can damage circuits in ways that may not be obvious, such as intermittent problems or a shortened product life span. As the industry pushes for lower power requirements and increased density, ESD protection is an increasing concern.

Two recognized types of ESD damage are catastrophic and intermittent failures.

- **Catastrophic** – Catastrophic failures represent approximately 20 percent of ESD-related failures. The damage causes an immediate and complete loss of device functionality. An example of catastrophic failure is a memory module that has



received a static shock and immediately generates a "No POST/No Video" symptom with a beep code that is emitted for missing or nonfunctional memory.

- **Intermittent** – Intermittent failures represent approximately 80 percent of ESD-related failures. The high rate of intermittent failures means that most of the time when damage occurs, it is not immediately recognizable. The memory module receives a static shock, but the tracing is merely weakened and does not immediately produce outward symptoms that are related to the damage. The weakened trace may take weeks or months to melt, and in the meantime may cause degradation of memory integrity, intermittent memory errors, and so on.


Intermittent failures that are also called latent or "walking wounded" are difficult to detect and troubleshoot.

Perform the following steps to prevent ESD damage:

- Use a wired ESD wrist strap that is properly grounded. Wireless anti-static straps do not provide adequate protection. Touching the chassis before handling parts does not ensure adequate ESD protection on parts with increased sensitivity to ESD damage.
- Handle all static-sensitive components in a static-safe area. If possible, use anti-static floor pads and workbench pads.
- When unpacking a static-sensitive component from its shipping carton, do not remove the component from the anti-static packing material until you are ready to install the component. Before unwrapping the anti-static packaging, use the anti-static wrist strap to discharge the static electricity from your body. For more information about the wrist strap and ESD wrist strap tester, see [Components of an ESD Field Service Kit](#).
- Before transporting a static-sensitive component, place it in an anti-static container or packaging.

## ESD Field Service kit

The unmonitored field service kit is the most commonly used service kit. Each Field Service kit includes three main components: anti-static mat, wrist strap, and bonding wire.

 **CAUTION: It is critical to keep ESD-sensitive devices away from internal parts that are insulated and often highly charged, such as plastic heat sink casings.**

## Working Environment

Before deploying the ESD Field Service kit, assess the situation at the customer location. For example, deploying the kit for a server environment is different than for a desktop or laptop environment. Servers are typically installed in a rack within a data center; desktops or laptops are typically placed on office desks or cubicles. Always look for a large open flat work area that is free of clutter and large enough to deploy the ESD kit with additional space to accommodate the type of computer that is being repaired. The workspace should also be free of insulators that can cause an ESD event. On the work area, insulators such as styrofoam and other plastics should always be moved at least 12 inches or 30 centimeters away from sensitive parts before physically handling any hardware components.

## ESD Packaging

All ESD-sensitive devices must be shipped and received in static-safe packaging. Metal, static-shielded bags are preferred. However, you should always return the damaged component using the same ESD bag and packaging that the new part arrived in. The ESD bag should be folded over and taped shut and all the same foam packing material should be used in the original box that the new part arrived in. ESD-sensitive devices should be removed from packaging only at an ESD-protected work surface, and parts should never be placed on top of the ESD bag because only the inside of the bag is shielded. Always place parts in your hand, on the anti-static mat, in the computer, or inside an ESD bag.

## Components of an ESD Field Service kit

The components of an ESD Field Service kit are:

- **Anti-Static Mat** – The anti-static mat is dissipative and parts can be placed on it during service procedures. When using an anti-static mat, your wrist strap should be snug and the bonding wire should be connected to the anti-static mat and to any bare metal on the computer being worked on. Once deployed properly, service parts can be removed from the ESD bag and placed directly on the anti-static mat. ESD-sensitive items are safe in your hand, on the anti-static mat, in the computer, or inside an ESD bag.
- **Wrist Strap and Bonding Wire** – The wrist strap and bonding wire can be either directly connected between your wrist and bare metal on the hardware if the anti-static mat is not required, or connect to the anti-static mat to protect hardware that is temporarily placed on the mat. The physical connection of the wrist strap and bonding wire between your skin, the anti-static mat, and the hardware is known as bonding. Use only Field Service kits with a wrist strap, anti-static mat, and

bonding wire. Never use wireless wrist straps. Always be cautious that the internal wires of a wrist strap are prone to damage from normal wear and tear, and must be checked regularly with a wrist strap tester in order to avoid accidental ESD hardware damage. It is recommended to test the wrist strap and bonding wire at least once per week.

- **ESD Wrist Strap Tester** – The wires inside an ESD strap are prone to damage over time. When using an unmonitored kit, it is a best practice to regularly test the strap before each service, and at a minimum, test once per week. A wrist strap tester is the best method for doing this test. To perform the test, plug the bonding-wire of the wrist-strap into the tester while it is strapped to your wrist and push the button to test. A green LED is lit if the test is successful; a red LED is lit and an alarm sounds if the test fails.

**NOTE:** It is recommended to always use the traditional wired ESD grounding wrist strap and protective anti-static mat when servicing Dell products. In addition, it is critical to keep sensitive parts separate from all insulator parts while servicing the computer.

## Transporting sensitive components

When transporting ESD sensitive components such as replacement parts or parts to be returned to Dell, it is critical to place these parts in anti-static bags for safe transport.

## After working inside your computer

### About this task

**CAUTION:** Leaving stray or loose screws inside your computer may severely damage your computer.

### Steps

1. Replace all screws and ensure that no stray screws remain inside your computer.
2. Connect any external devices, peripherals, or cables you removed before working on your computer.
3. Replace any media cards, disks, or any other parts that you removed before working on your computer.
4. Connect your computer to their electrical outlets.

**NOTE:** To exit service mode, ensure to connect the AC adapter to the power-adapter port on your computer.

5. Press the power button to turn on the computer.

## BitLocker

**CAUTION:** If BitLocker is not suspended before updating the BIOS, the BitLocker key is not recognized the next time that you reboot the computer. You will be prompted to enter the recovery key to progress, and the computer displays a prompt for the recovery key on each reboot. If the recovery key is not known, this can result in data loss or an operating system reinstall. For more information, see Knowledge Article: [updating the BIOS on Dell computers with BitLocker enabled](#).

The installation of the following components triggers BitLocker:

- Hard disk drive or solid state drive
- System board

## Recommended tools

















The procedures in this document may require the following tools:

- Phillips screwdriver #0
- Flat-headed screwdriver (maximum width: 4 mm)
- Plastic scribe









# Screw list

- NOTE:** When removing screws from a component, it is recommended to note the screw type and the quantity of screws, and then place them in a screw storage box. This is to ensure that the correct number of screws and correct screw type is restored when the component is replaced.
- NOTE:** Some computers have magnetic surfaces. Ensure that the screws are not left attached to such surfaces when replacing a component.
- NOTE:** Screw color may vary depending on the configuration ordered.

**Table 32. Screw list**

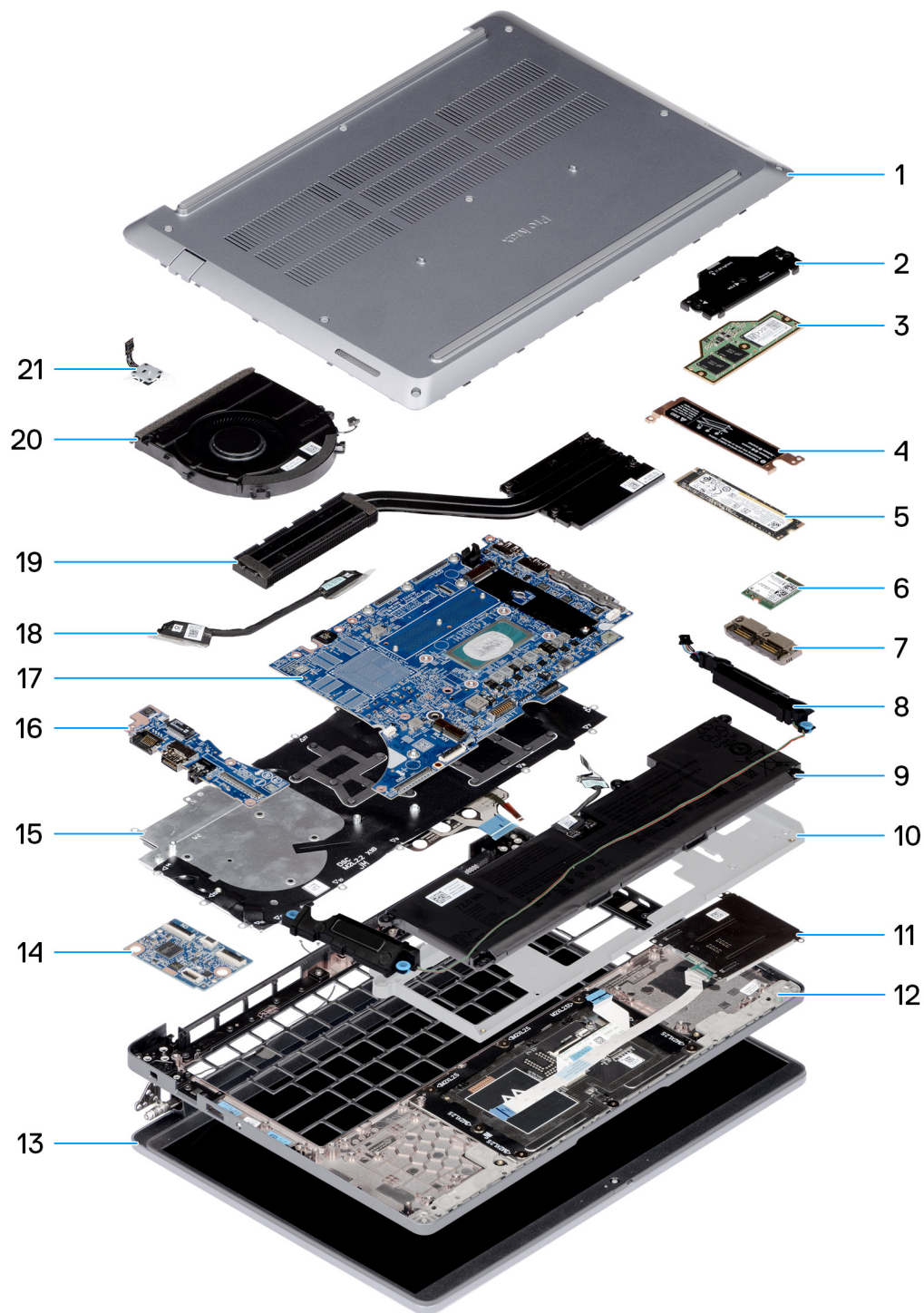
Component	Screw type	Quantity	Screw image
Base cover	Captive screw <b>NOTE:</b> Screws are part of the base cover.	8	
Battery	M2x4	5	
Memory-module bracket	M2x6	3	
Solid state drive bracket	M2x3	2	
Solid state drive	M2x4	1	
Wireless-card bracket	M2x3	1	
Speakers	M1.6x3	4	
Fan	M2x4	2	
Battery frame	M2x3	7	
USH board	M2x2	2	
Smart-card reader	M2x2.2	4	
Heat sink	Captive screw <b>NOTE:</b> Screws are part of the heat sink.	4	
I/O board	M2x3	2	
Fingerprint-reader bracket	M2x4	1	
Power button	M2x2	1	
Display-cable bracket	M2x3	3	

**Table 32. Screw list (continued)**

Component	Screw type	Quantity	Screw image
Display assembly	M2.5x4.5	6	
Display panel	M2x3	4	
Display hinges	M2.5x3.5	6	
System board	M2x6	2	
	M2x3	3	
USB Type-C module	M2x5	3	
Keyboard	M2x2.2	18	
Keyboard bracket	M2x2.2	3	

## Major components of Dell Pro Max 14 MC14250


The following image shows the major components of Dell Pro Max 14 MC14250.



**Figure 10. Major components of your Dell Pro Max 14 MC14250**

1. Base cover
2. Memory-module bracket
3. Memory module
4. Solid state drive bracket
5. Solid state drive
6. Wireless card
7. USB Type-C module
8. Speakers
9. Battery


10. Battery frame
11. Smart-card reader
12. Palm-rest assembly
13. Display assembly
14. USH board
15. Keyboard assembly
16. I/O board
17. System board
18. I/O-board cable
19. Heat sink
20. Fan
21. Power button with optional fingerprint reader

 **NOTE:** Dell Technologies provides a list of components and their part numbers for the original system configuration purchased. These parts are available according to warranty coverages purchased by the customer. Contact your Dell sales representative for purchase options.

# Removing and installing Customer Replaceable Units (CRUs)

The replaceable components in this chapter are Customer Replaceable Units (CRUs).

 **CAUTION:** Customers can replace only the Customer Replaceable Units (CRUs) following the safety precautions and replacement procedures.


 **NOTE:** The images in this document may differ from your computer depending on the configuration you ordered.

## Base cover

### Removing the base cover

#### Prerequisites

1. Follow the procedure in [Before working inside your computer](#).

 **CAUTION:** Ensure that your computer is in Service Mode. If the computer does not turn on, does not enter Service Mode, or does not support Service Mode, proceed to disconnect the battery cable.

#### About this task

The following images indicate the location of the base cover and provide a visual representation of the removal procedure.





8x



Figure 11. Removing the base cover



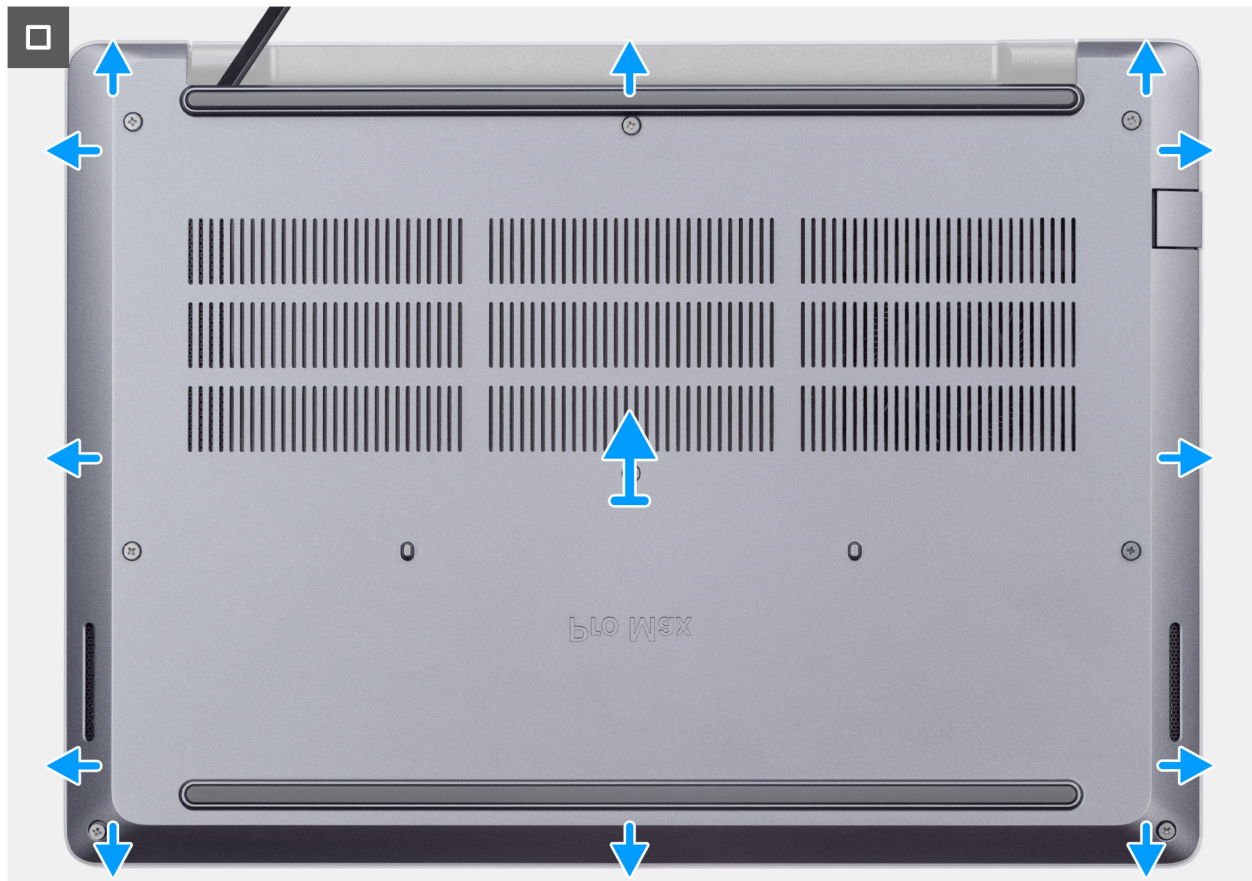


Figure 12. Removing the base cover

### Steps

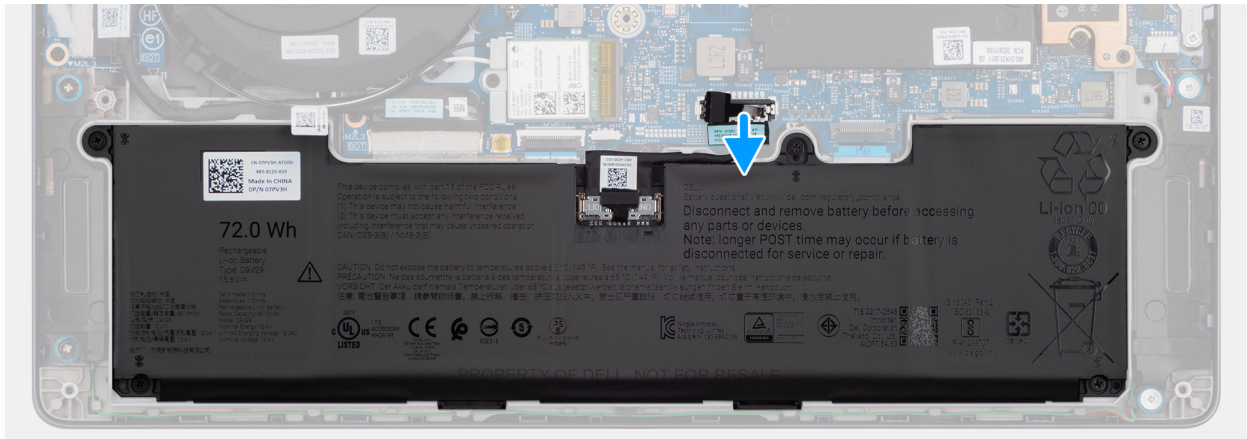
1. Loosen the eight captive screws that secure the base cover to the palm-rest assembly.
2. Using a plastic scribe, pry open the base cover starting from the recesses, which are located at the top edge of the base cover, near the hinges.

**CAUTION:** Do not slide the scribe along the edges of the base cover as it may damage the latches inside the base cover. Instead, insert the scribe at regular intervals and pry open the base cover.

3. Pry open the top of the base cover followed by the left, right, and bottom to release the base cover.
4. Lift the base cover off the palm-rest assembly.

**NOTE:** Ensure that your computer is in Service Mode. If your computer is unable to enter Service Mode, then disconnect the battery cable from the system board.

5. Disconnect the battery cable from the battery cable connector (BATT) on the system board.



**Figure 13. Removing the battery cable**

6. Press and hold the power button for five seconds to ground the computer and drain the flea power.

## Installing the base cover

### Prerequisites

If you are replacing a component, remove the existing component before performing the installation procedure.

### About this task

The following images indicate the location of the base cover and provide a visual representation of the installation procedure.



8x

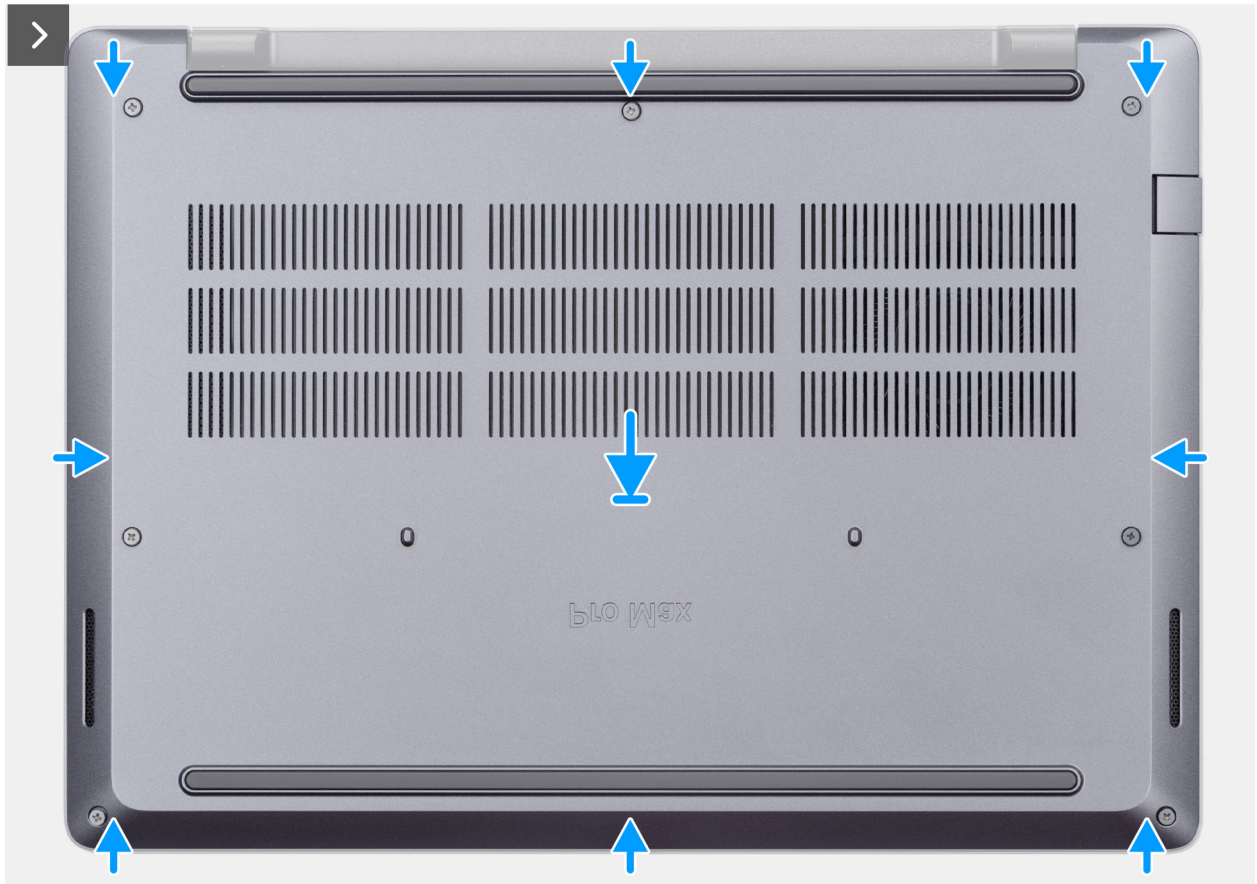


Figure 14. Installing the base cover



Figure 15. Installing the base cover

### Steps

1. Connect the battery cable to the connector (BATT) on the system board.  
**NOTE:** This step applies only to computers that are not in Service Mode.
2. Place the base cover on the palm-rest assembly.
3. Align the screw holes on the base cover with the screw holes on the palm-rest assembly, and then snap the base cover into place.
4. Tighten the eight captive screws to secure the base cover to the palm-rest assembly.

### Next steps

1. Follow the procedure in [After working inside your computer](#).

## Battery

### Rechargeable Li-ion battery precautions

#### CAUTION:

- Exercise caution when handling rechargeable Li-ion batteries.
- Discharge the battery completely before removing it. Disconnect the AC power adapter from the computer and operate the computer solely on battery power—the battery is fully discharged when the computer no longer turns on when the power button is pressed.
- Do not crush, drop, mutilate, or penetrate the battery with foreign objects.
- Do not expose the battery to high temperatures, or disassemble battery packs and cells.



- Do not apply pressure to the surface of the battery.
- Do not bend the battery.
- Do not use tools of any kind to pry on or against the battery.
- To prevent accidental puncture or damage to the battery and other components, ensure that no screws are lost or misplaced during the servicing of this product.
- If the battery gets stuck inside your computer due to swelling, do not try to release it as, puncturing, bending, or crushing a rechargeable Li-ion battery can be dangerous. In such an instance, contact Dell technical support for assistance. See [Contact Support at Dell Support Site](#).
- Always purchase genuine batteries from [Dell Site](#) or authorized Dell partners and resellers.
- Swollen batteries should not be used and should be replaced and disposed properly. For guidelines on how to handle and replace swollen rechargeable Li-ion batteries, see [Handling swollen rechargeable Li-ion batteries](#).

## Removing the battery

### Prerequisites

1. Follow the procedure in [Before working inside your computer](#).
2. Remove the [base cover](#).

### About this task

**CAUTION:** Removing the battery resets the BIOS setup settings to default. It is recommended that you note the BIOS setup settings before removing the battery.

The following image indicates the location of the battery and provides a visual representation of the removal procedure.

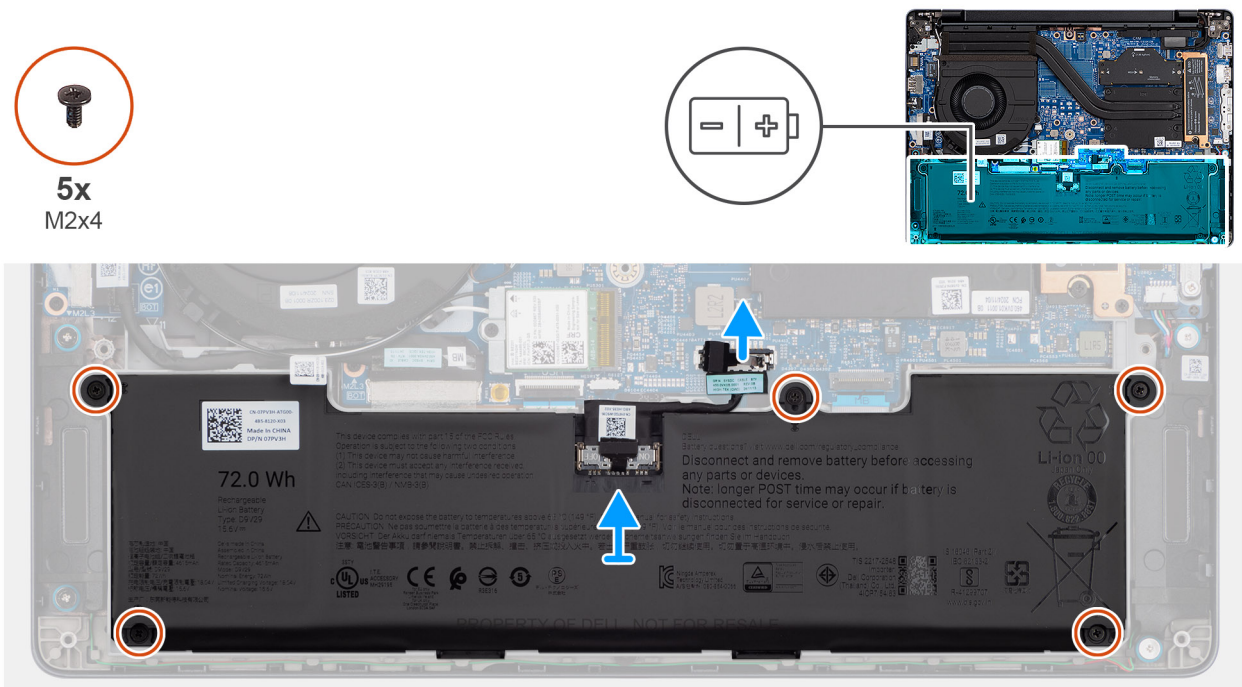


Figure 16. Removing the battery

### Steps

1. Disconnect the battery cable from the connector (BATT) on the system board.
2. Remove the five screws (M2x4) that secure the battery to the battery frame.
3. Lift the battery, along with the battery cable, off the palm-rest assembly.

# Installing the battery

## Prerequisites

If you are replacing a component, remove the existing component before performing the installation procedure.

## About this task

The following image indicates the location of the battery and provides a visual representation of the installation procedure.

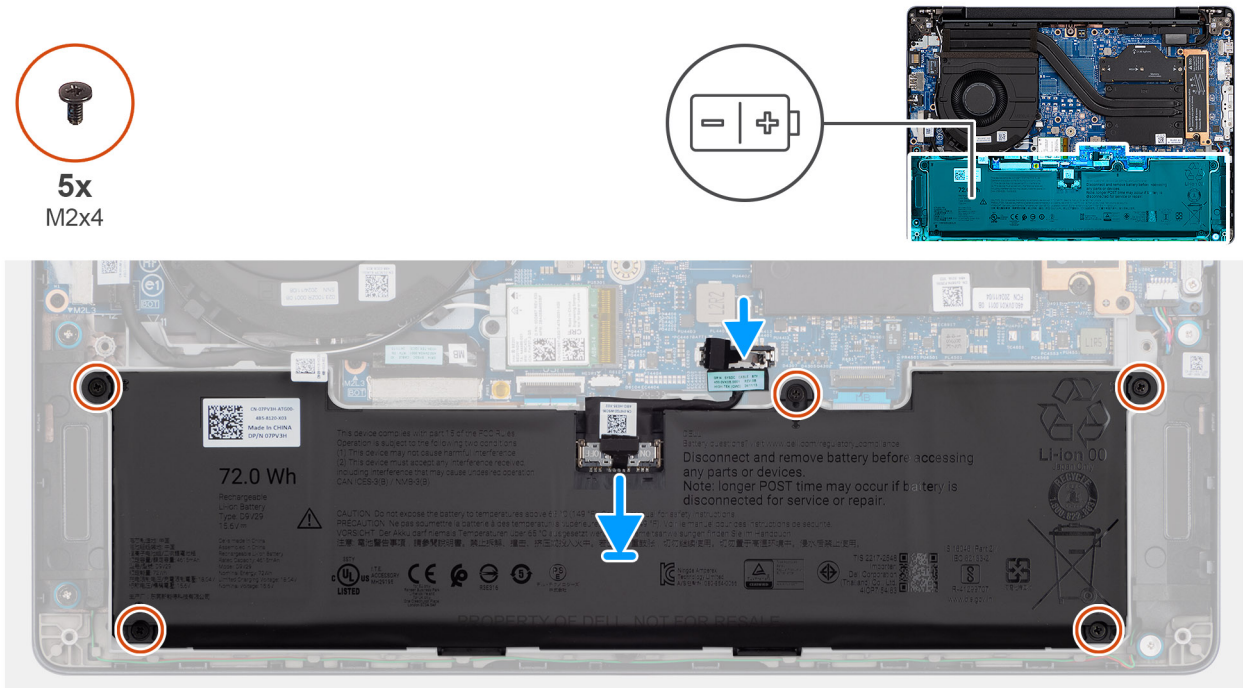


Figure 17. Installing the battery

## Steps

1. Place the battery, along with the battery cable, in the battery frame on the palm-rest assembly.
2. Align the screw holes on the battery with the screw holes on the battery frame.
3. Replace the five screws (M2x4) to secure the battery to the battery frame.
4. Connect the battery cable to the connector (BATT) on the system board.

## Next steps

1. Install the [base cover](#).
2. Follow the procedure in [After working inside your computer](#).

# Memory module

## Removing the memory module

### Prerequisites

1. Follow the procedure in [Before working inside your computer](#).
2. Remove the [base cover](#).

## About this task

The following images indicate the location of the memory module and provide a visual representation of the removal procedure.

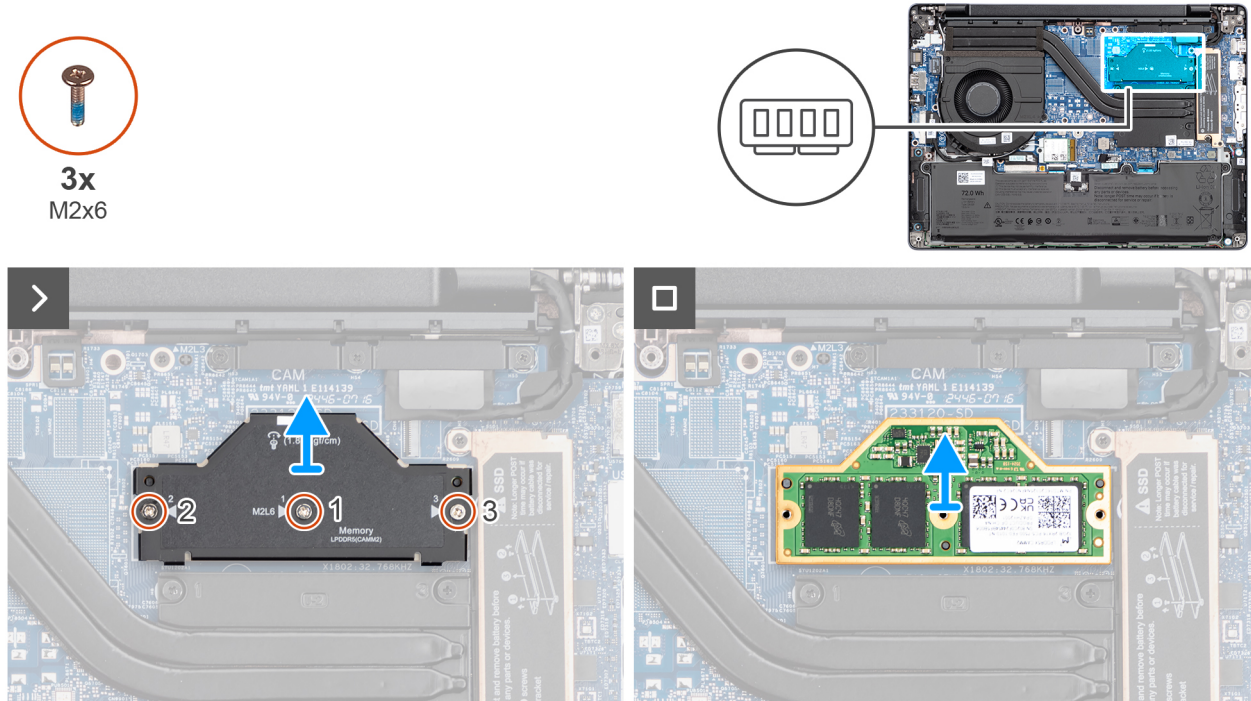


Figure 18. Removing the memory module

## Steps

1. In sequential order (1 > 2 > 3), remove the three screws (M2x6) that secure the memory-module bracket to the system board.
2. Lift the memory-module bracket away from the system board.
3. Carefully lift the memory module away from the memory-module connector.

**CAUTION:** To prevent damage to the memory module, hold the memory module by the edges. Do not touch the components or metallic contacts on the memory module as electrostatic discharge (ESD) can inflict severe damage on the components. To read more about ESD protection, see [ESD protection](#).

**CAUTION:** When removing the memory module from the system board, ensure that the memory-module connector is not lifted or moved. The connector pins are fragile and any direct contact with the pins may damage them.

**NOTE:** The memory-module bracket and memory-module connector are non-serviceable parts. When replacing the memory module, they must be used with the new replacement memory module.

## Installing the memory module

### Prerequisites

If you are replacing a component, remove the existing component before performing the installation procedure.

### About this task

The following images indicate the location of the memory module and provide a visual representation of the installation procedure.



3x  
M2x6

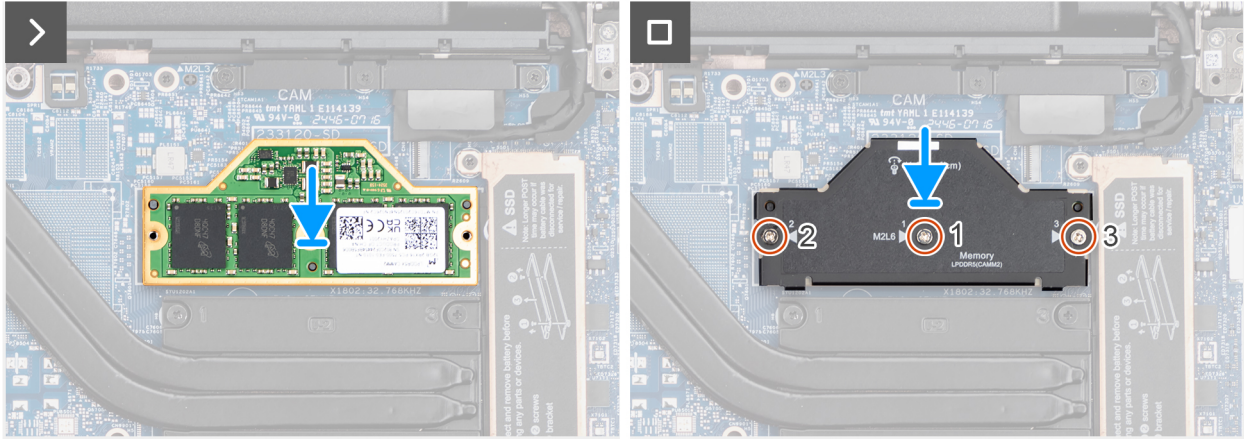
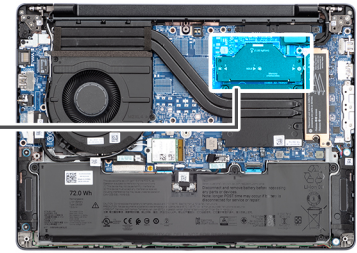
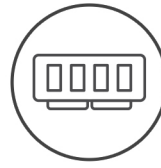


Figure 19. Installing the memory module

### Steps

1. Align and place the memory module on the memory-module connector plate.

**CAUTION:** To prevent damage to the memory module, hold the memory module by the edges. Do not touch the components or metallic contacts on the memory module as electrostatic discharge (ESD) can inflict severe damage on the components. To read more about ESD protection, see [ESD protection](#).

**CAUTION:** When replacing the memory module to the system board, ensure that the memory-module connector is not pressed or moved. The connector pins are fragile and any direct contact with the pins may damage them.

**NOTE:** The memory-module bracket and memory-module connector are non-serviceable parts. When replacing the memory module, they must be used with the new replacement memory module.

2. Align and place the memory-module bracket on the memory module.
3. In sequential order (1 > 2 > 3 ), replace the three screws (M2x6) to secure the memory-module bracket to the system board.

### Next steps

1. Install the [base cover](#).
2. Follow the procedure in [After working inside your computer](#).

## Solid State Drive (SSD)

### Removing the M.2 2230 solid state drive

#### Prerequisites

1. Follow the procedure in [Before working inside your computer](#).
2. Remove the [base cover](#).



### About this task

The following images indicate the location of the M.2 2230 solid state drive (SSD) and provide a visual representation of the removal procedure.

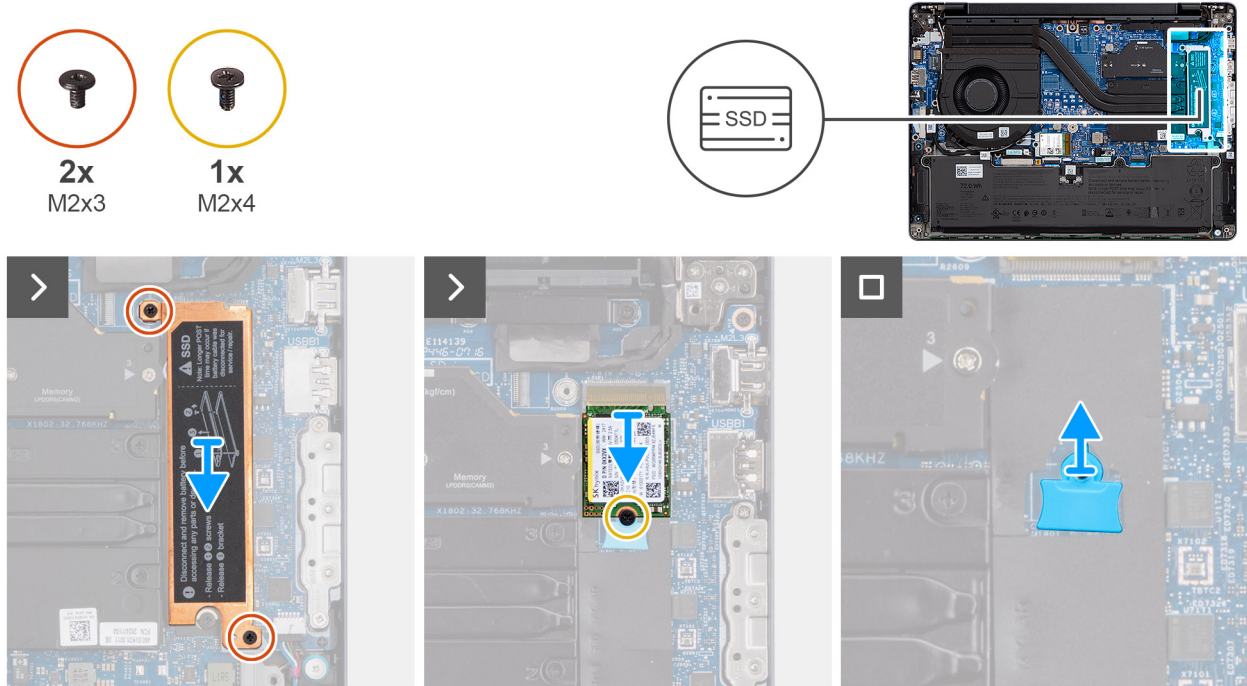


Figure 20. Removing the M.2 2230 solid state drive

### Steps

1. Remove the two screws (M2x3) that secure the M.2 2230 SSD bracket to the system board.
2. Lift the M.2 2230 SSD bracket off the M.2 2230 solid state drive.
3. Remove the screw (M2x4) that secures the M.2 2230 solid state drive to the palm-rest assembly.
4. Remove the M.2 2230 solid state drive from the M.2 card slot (SSD) on the system board.
5. Remove the M.2230 SSD holder from the system board.

**NOTE:** This step applies only if you are replacing a M.2 2230 solid state drive with a M.2 2280 solid state drive.

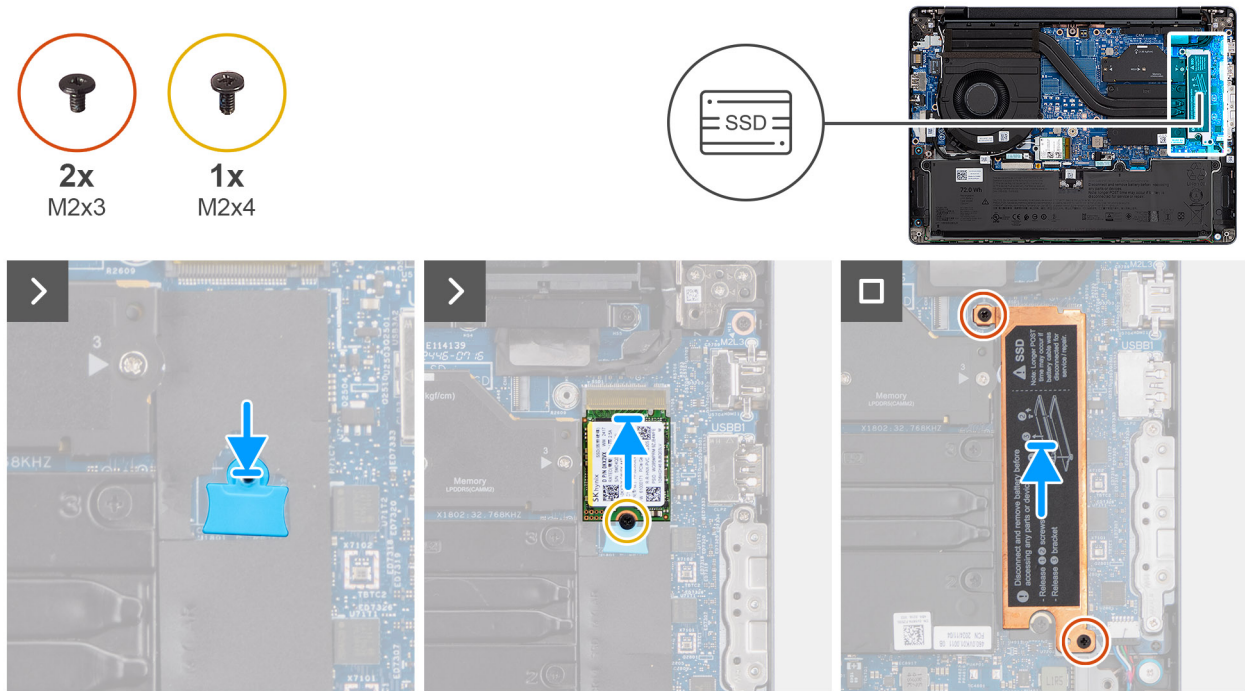
## Installing the M.2 2230 solid state drive

### Prerequisites

If you are replacing a component, remove the existing component before performing the installation procedure.

### About this task

The following images indicate the location of the M.2 2230 solid state drive (SSD) and provide a visual representation of the installation procedure.



**Figure 21. Installing the M.2 2230 solid state drive**

### Steps

1. Align and place the M.2230 SSD holder in its slot on the system board.
  - i** **NOTE:** This step applies only if you are replacing a M.2 2280 solid state drive with a M.2 2230 solid state drive.
2. Align the notch on the M.2 2230 solid state drive to the tab on the M.2 card slot (SSD) on the system board.
3. Slide the M.2 2230 solid state drive at an angle into the M.2 card slot on the system board.
4. Replace the screw (M2x4) to secure the M.2 2230 solid state drive to the palm-rest assembly.
5. Align and place the M.2 2230 SSD bracket on the M.2 2230 solid state drive.
6. Replace the two screws (M2x3) to secure the M.2 2230 SSD bracket to the system board.

### Next steps

1. Install the [base cover](#).
2. Follow the procedure in [After working inside your computer](#).

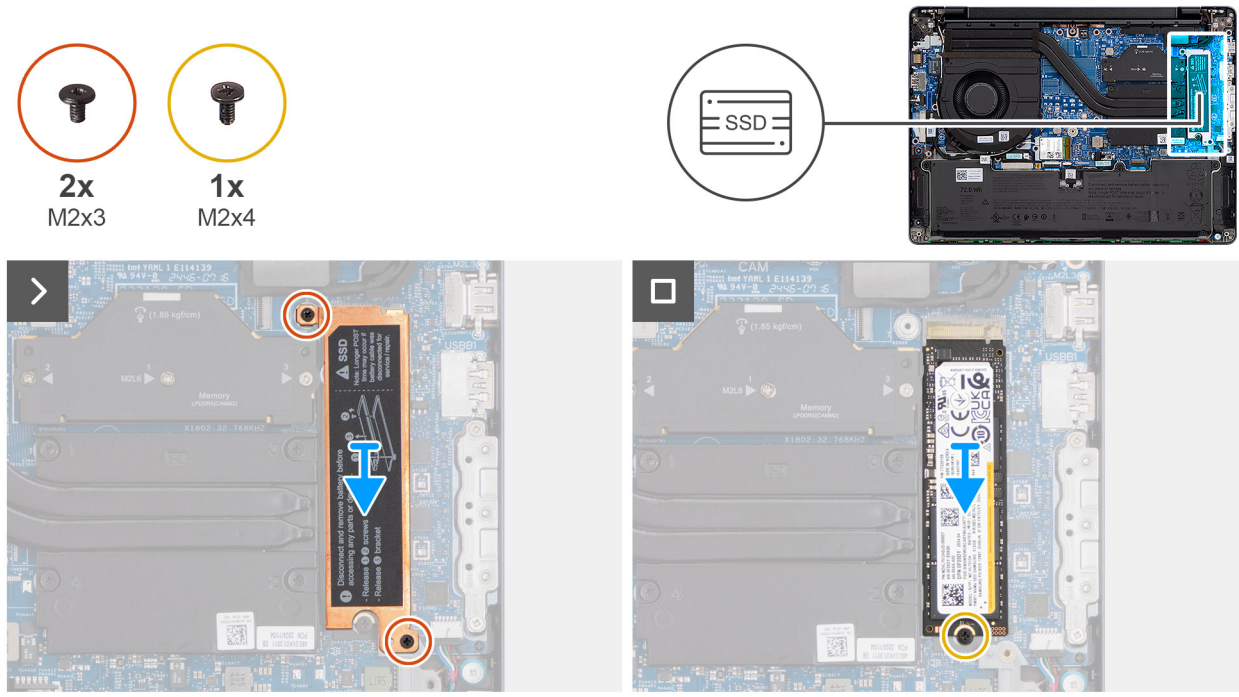
## Removing the M.2 2280 solid state drive

### Prerequisites

1. Follow the procedure in [Before working inside your computer](#).
2. Remove the [base cover](#).

### About this task

The following images indicate the location of the M.2 2280 solid state drive (SSD) and provide a visual representation of the removal procedure.



**Figure 22. Removing the M.2 2280 solid state drive**

**Steps**

1. Remove the two screws (M2x3) that secure the M.2 2280 SSD bracket to the system board.
2. Lift the M.2 2280 SSD bracket off the M.2 2280 solid state drive.
3. Remove the screw (M2x4) that secures the M.2 2280 solid state drive to the system board.
4. Remove the M.2 2280 solid state drive from the M.2 card slot (SSD) on the system board.

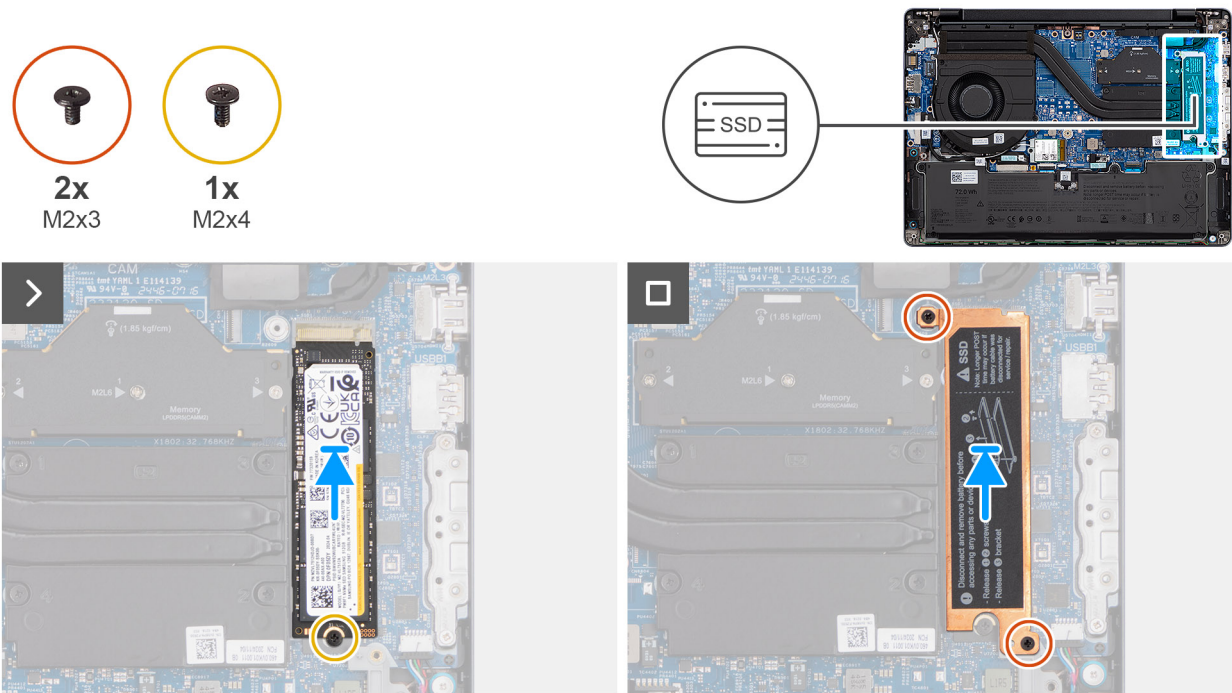
## Installing the M.2 2280 solid state drive

**Prerequisites**

If you are replacing a component, remove the existing component before performing the installation procedure.

**About this task**

The following images indicate the location of the M.2 2280 solid state drive (SSD) and provide a visual representation of the installation procedure.



**Figure 23. Installing the M.2 2280 solid state drive**

**Steps**

1. Align the notch on the M.2 2280 solid state drive to the tab on the M.2 card slot (SSD) on the system board.
2. Slide the M.2 2280 solid state drive at an angle into the M.2 card slot on the system board.
3. Replace the screw (M2x4) to secure the M.2 2280 solid state drive to the system board.
4. Align and place the M.2 2280 SSD bracket on the M.2 2280 solid state drive.
5. Replace the two screws (M2x3) to secure the M.2 2280 SSD bracket to the system board.

**Next steps**

1. Install the [base cover](#).
2. Follow the procedure in [After working inside your computer](#).

## Wireless card

### Removing the wireless card

**Prerequisites**

1. Follow the procedure in [Before working inside your computer](#).
2. Remove the [base cover](#).

**About this task**

The following images indicate the location of the wireless card and provide a visual representation of the removal procedure.





1x  
M2x3

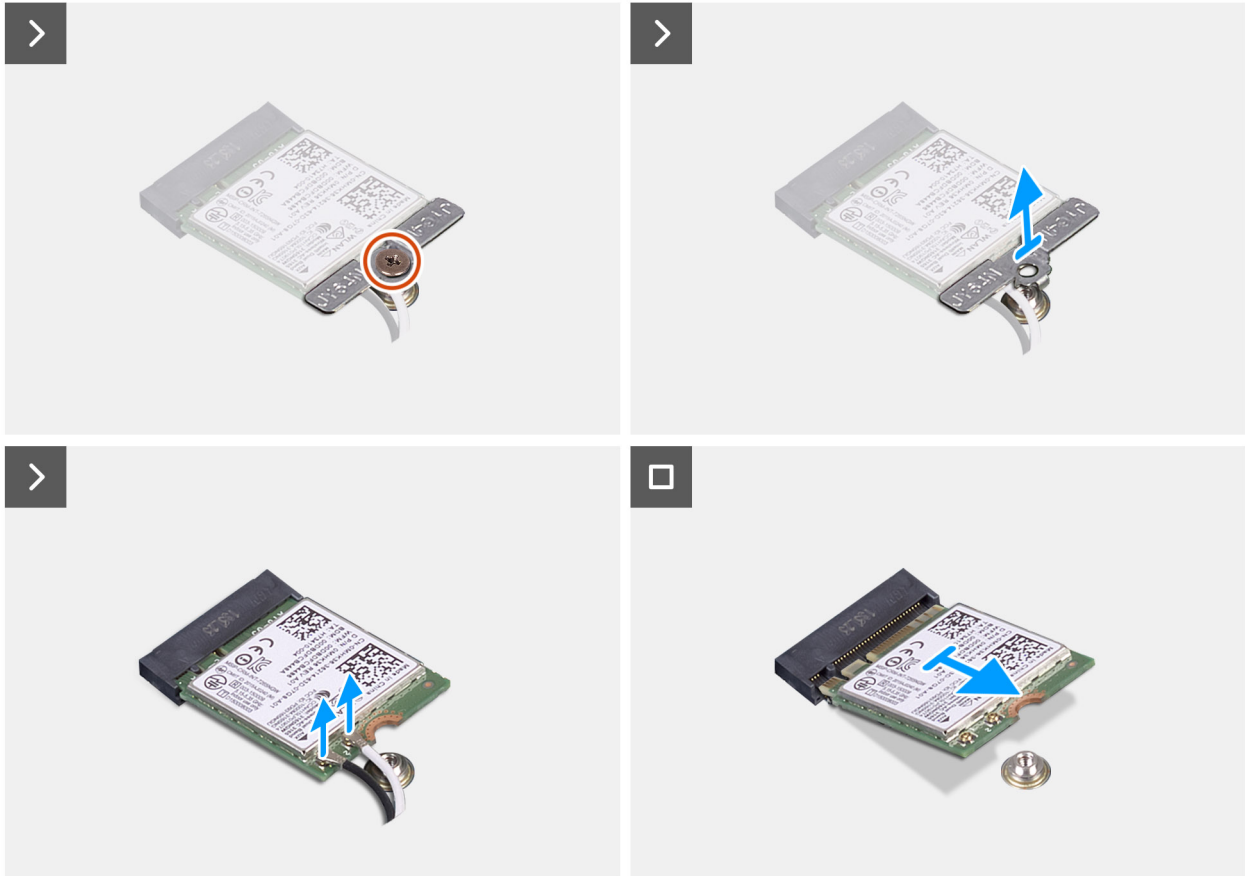


Figure 24. Removing the wireless card

### Steps

1. Remove the screw (M2x3) that secures the wireless-card bracket to the system board.
2. Lift the wireless-card bracket off the wireless card.
3. Disconnect the wireless-antenna cables from the connectors on the wireless card.
4. Slide and remove the wireless card from the wireless-card slot (WLAN) on the system board.

## Installing the wireless card

### Prerequisites

If you are replacing a component, remove the existing component before performing the installation procedure.

### About this task

The following images indicate the location of the wireless card and provide a visual representation of the installation procedure.



1x  
M2x3

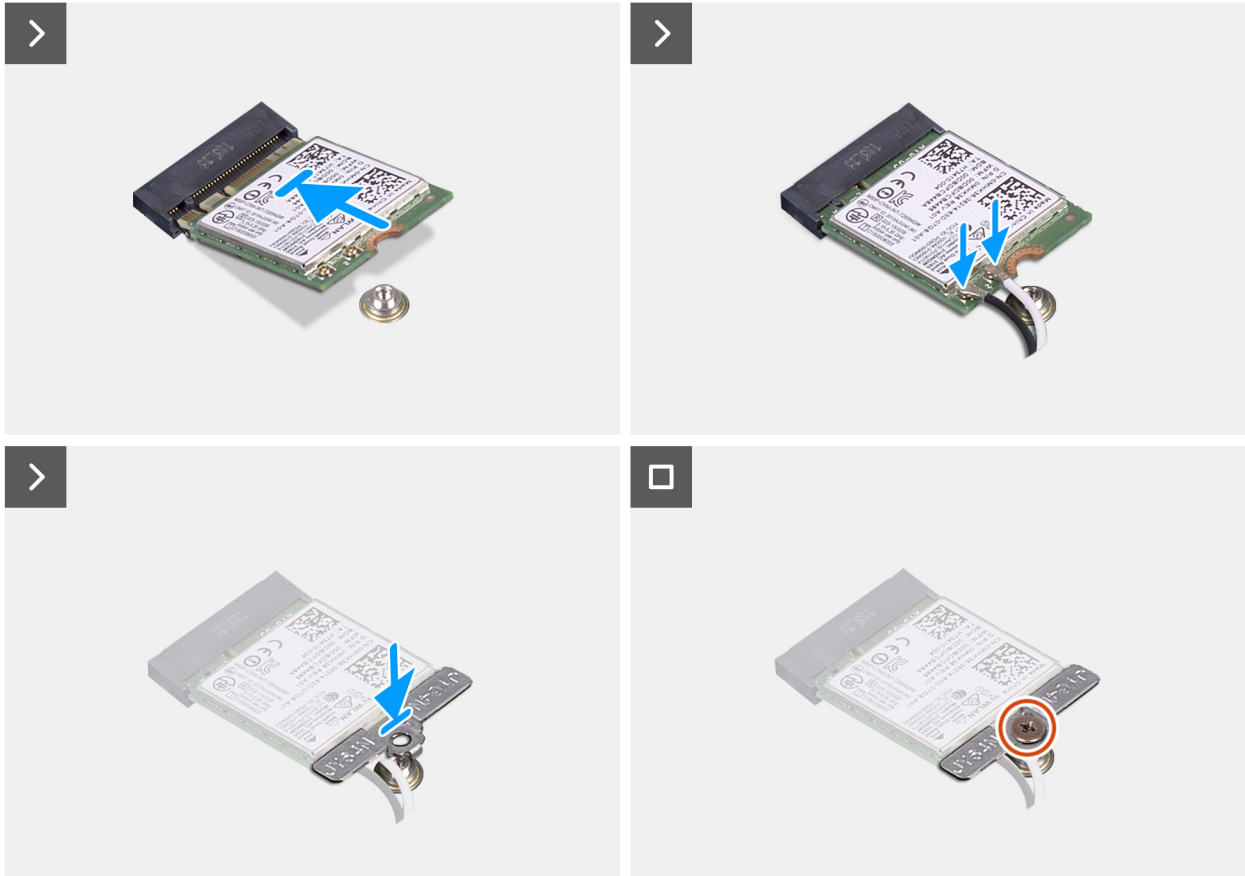
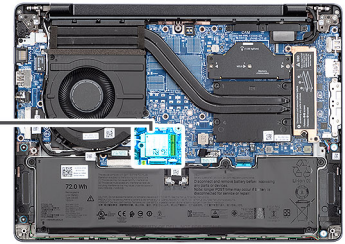


Figure 25. Installing the wireless card

### Steps

1. Align the notch on the wireless card to the tab on the wireless-card slot (WLAN) on the system board.
2. Slide the wireless card at an angle into the wireless-card slot on the system board.
3. Connect the wireless-antenna cables to the connectors on the wireless card.

The following table provides the antenna-cable color scheme for the wireless card supported by your computer.

Table 33. Antenna-cable color scheme

Connector on the wireless card	Antenna-cable color	Silkscreen marking	
Main	White	MAIN	△ (white triangle)
Auxiliary	Black	AUX	▲ (black triangle)

4. Place the wireless-card bracket on the wireless card.
5. Align the screw hole on the wireless-card bracket with the screw hole on the system board.
6. Replace the screw (M2x3) to secure the wireless-card bracket and the wireless card to the system board.

### Next steps

1. Install the [base cover](#).
2. Follow the procedure in [After working inside your computer](#).

## Speakers

### Removing the speakers

#### Prerequisites

1. Follow the procedure in [Before working inside your computer](#).
2. Remove the [base cover](#).

#### About this task

The following images indicate the location of the speakers and provide a visual representation of the removal procedure.

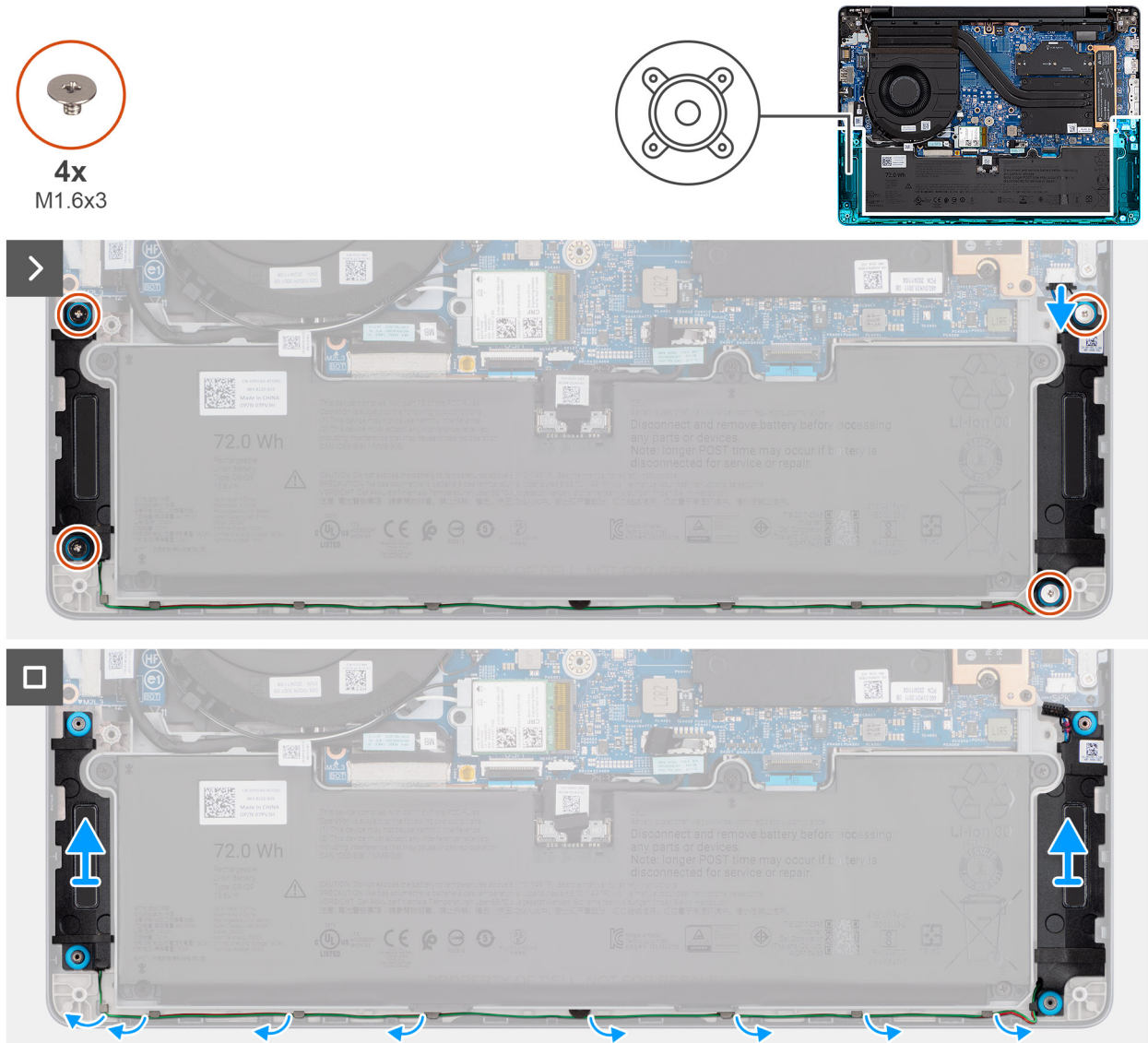


Figure 26. Removing the speakers

## Steps

1. Disconnect the speaker cable from the connector (SPK) on the system board.
2. Remove the four screws (M1.6x3) that secure the speakers to the palm-rest assembly.
3. Carefully remove the speaker cable from the routing guides on the palm-rest assembly.
4. Lift the speakers, along with the cable, off the palm-rest assembly.

## Installing the speakers

### Prerequisites

If you are replacing a component, remove the existing component before performing the installation procedure.

### About this task

**NOTE:** If the rubber grommets are pushed out when removing the speakers, push them back in before replacing the speakers.

The following images indicate the location of the speakers and provide a visual representation of the installation procedure.

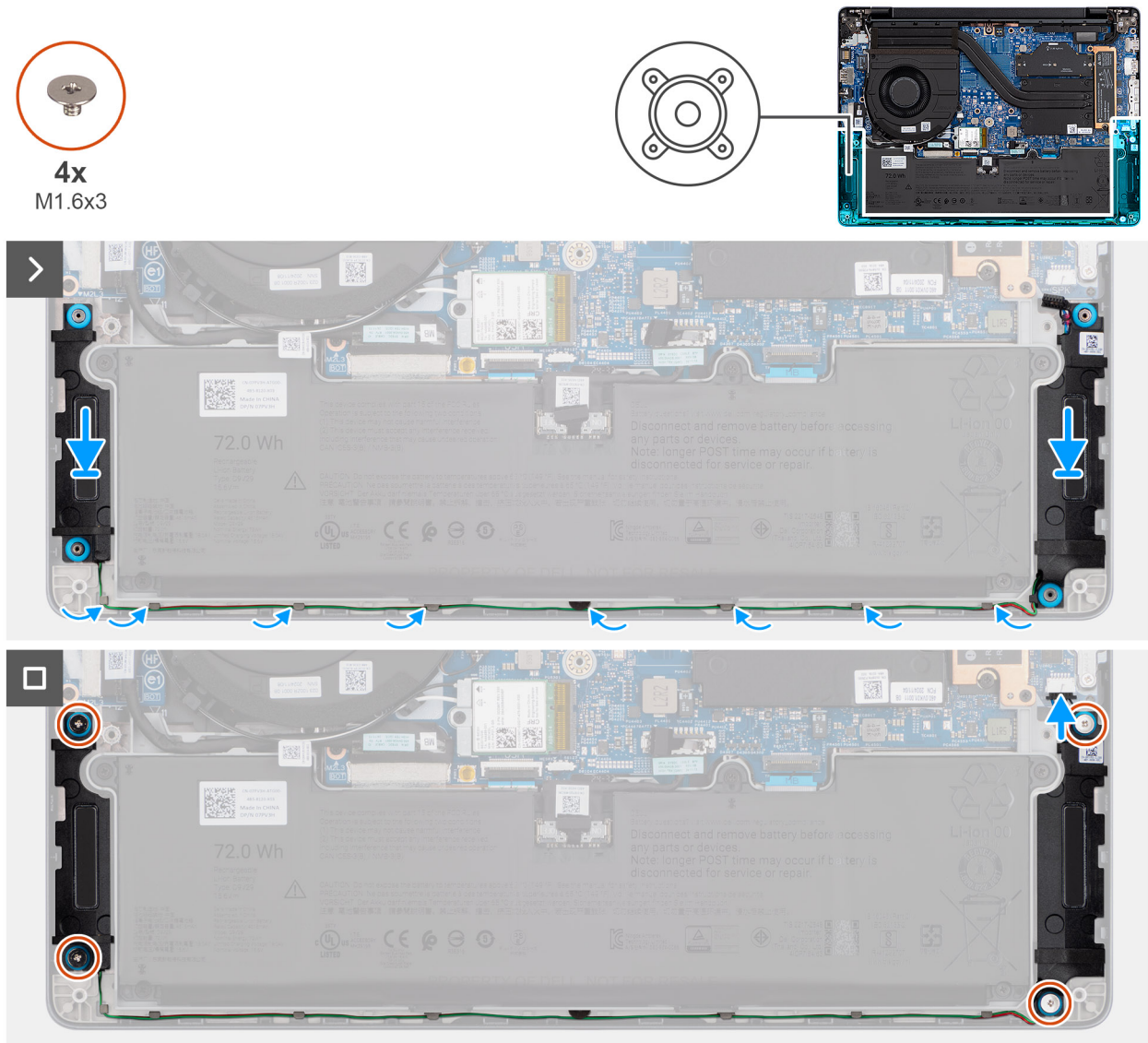


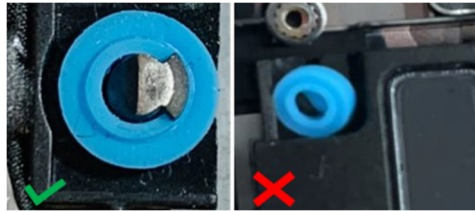
Figure 27. Installing the speakers



### Steps

1. Using the alignment posts and rubber grommets, place the speakers in the slots on the palm-rest assembly.

**i** **NOTE:** Ensure that the rubber grommets on the speakers are threaded through the alignment posts. Ensure that the four rubber grommets are seated into the slot and installed on the speakers properly.



**Figure 28. Installing the speakers**

2. Route the speaker cable through the routing guides on the palm-rest assembly.
3. Replace the four screws (M1.6x3) to secure the speakers to the palm-rest assembly.
4. Connect the speaker cable to the connector (SPK) on the system board.

### Next steps

1. Install the [base cover](#).
2. Follow the procedure in [After working inside your computer](#).

## Fan

### Removing the fan

#### Prerequisites

1. Follow the procedure in [Before working inside your computer](#).
2. Remove the [base cover](#).
3. Remove the [wireless card](#).

#### About this task

The following images indicate the location of the fan and provide a visual representation of the removal procedure.



2x  
M2x4

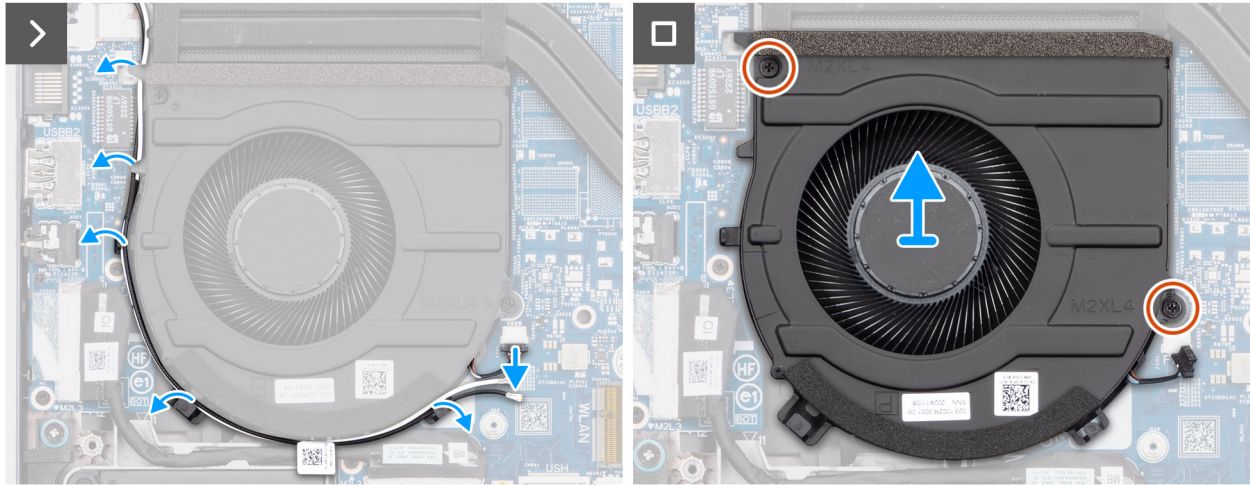
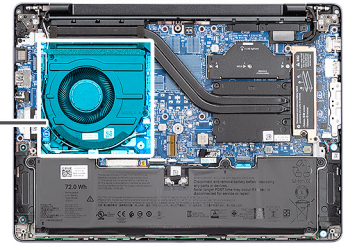
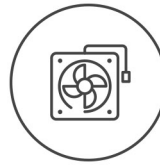


Figure 29. Removing the fan

### Steps

1. Disconnect the fan cable from the connector (FAN) on the system board.
2. Carefully remove the wireless-antenna cables from the routing guides on the fan.
3. Remove the two screws (M2x4) that secure the fan to the palm-rest assembly.
4. Lift the fan off the palm-rest assembly.

## Installing the fan

### Prerequisites

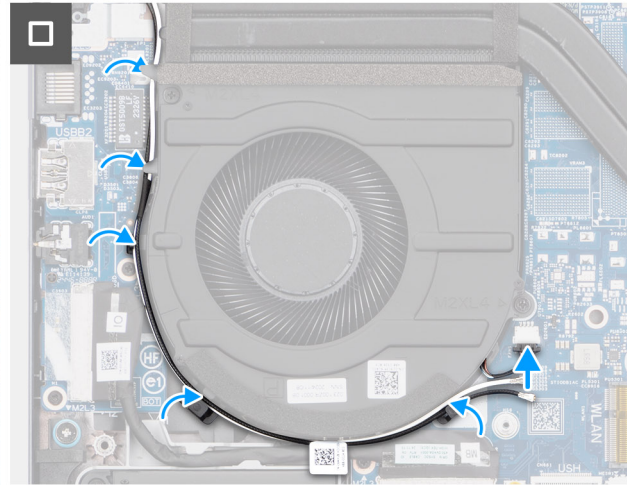
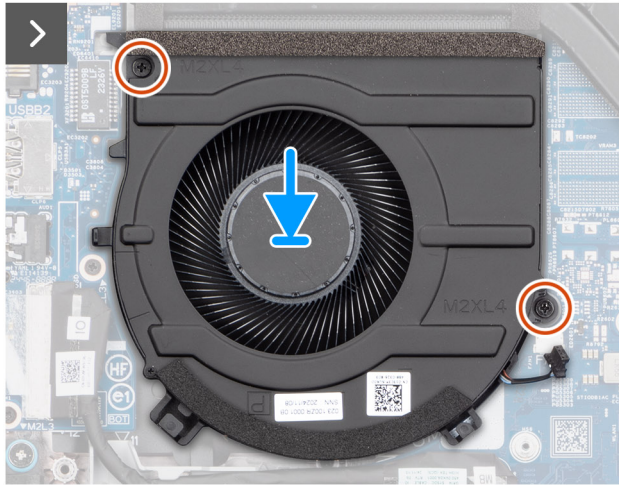
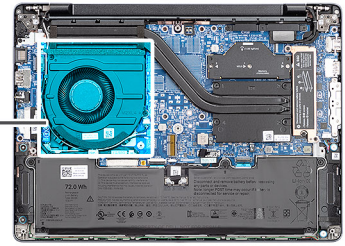
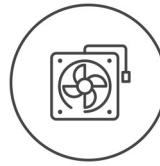
If you are replacing a component, remove the existing component before performing the installation procedure.

### About this task

The following images indicate the location of the fan and provide a visual representation of the installation procedure.



2x  
M2x4



**Figure 30. Installing the fan**

**Steps**


1. Place the fan in the slot on the palm-rest assembly.
2. Align the screw holes on the fan with the screw holes on the palm-rest assembly.
3. Replace the two screws (M2x4) to secure the fan to the palm-rest assembly.
4. Route the wireless-antenna cables through the routing guides on the fan.
5. Connect the fan cable to the connector (FAN) on the system board.


**Next steps**

1. Install the [wireless card](#).
2. Install the [base cover](#).
3. Follow the procedure in [After working inside your computer](#).


# Removing and installing Field Replaceable Units (FRUs)


The replaceable components in this chapter are Field Replaceable Units (FRUs).

 **CAUTION:** The information in this section is intended for authorized service technicians only.

 **CAUTION:** To avoid any potential damage to the component or loss of data, ensure that an authorized service technician replaces the Field Replaceable Units (FRUs).

 **CAUTION:** Dell Technologies recommends that these procedures be performed by trained technical repair specialists.

 **CAUTION:** Your warranty does not cover damages that may occur during FRU repairs that are not authorized by Dell Technologies.

 **NOTE:** The images in this document may differ from your computer depending on the configuration you ordered.

## Battery cable

### Disconnecting the battery cable

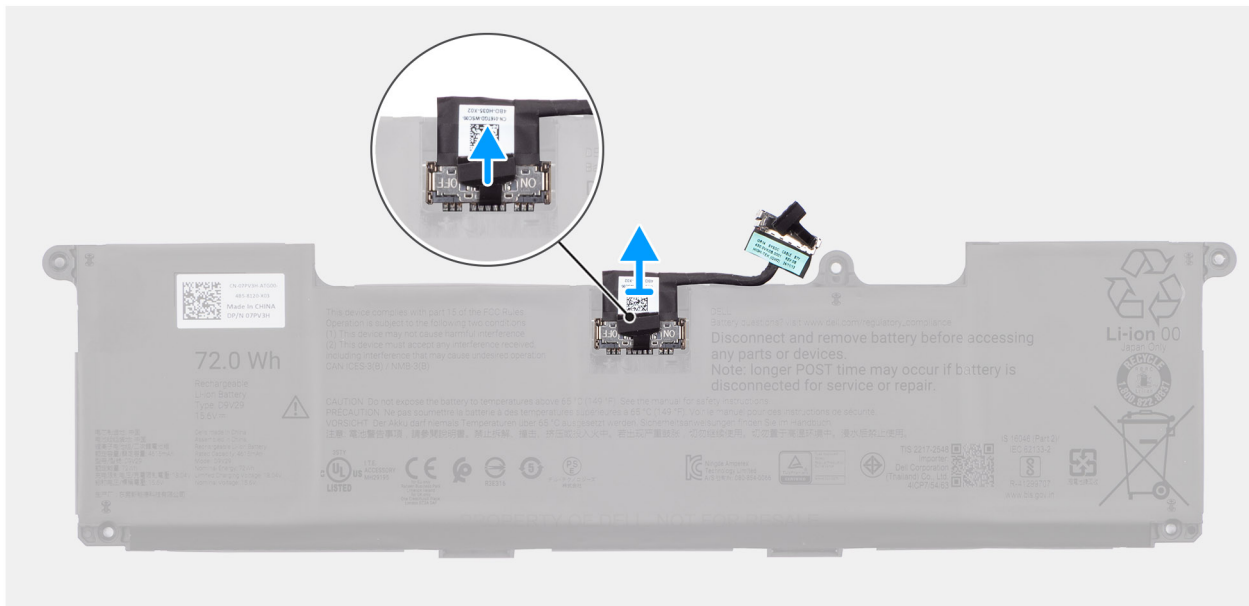
 **CAUTION:** The information in this removal section is intended for authorized service technicians only.

#### Prerequisites

1. Follow the procedure in [Before working inside your computer](#).
2. Remove the [base cover](#).
3. Remove the [battery](#).

#### About this task

The following image indicates the location of the battery cable and provides a visual representation of the removal procedure.



**Figure 31. Disconnecting the battery cable**

### Steps

1. Peel back the battery cable from the battery.
2. Disconnect the battery cable from the connector on the battery.

## Connecting the battery cable

**CAUTION:** The information in this installation section is intended for authorized service technicians only.

### Prerequisites

If you are replacing a component, remove the existing component before performing the installation procedure.

### About this task

The following image indicates the location of the battery cable and provides a visual representation of the installation procedure.

### Steps

1. Connect the battery cable to the connector on the battery.

**NOTE:** The connector on the battery cable has a switch that enables power supply to the computer. When connecting the battery cable to the battery, ensure that the switch on the connector is turned on.

2. Adhere the battery cable to the battery.

### Next steps

1. Install the [battery](#).
2. Install the [base cover](#).
3. Follow the procedure in [After working inside your computer](#).



# Battery frame

## Removing the battery frame

**CAUTION:** The information in this removal section is intended for authorized service technicians only.

### Prerequisites

1. Follow the procedure in [Before working inside your computer](#).
2. Remove the [base cover](#).
3. Remove the [battery](#).

### About this task

The following images indicate the location of the battery frame and provide a visual representation of the removal procedure.

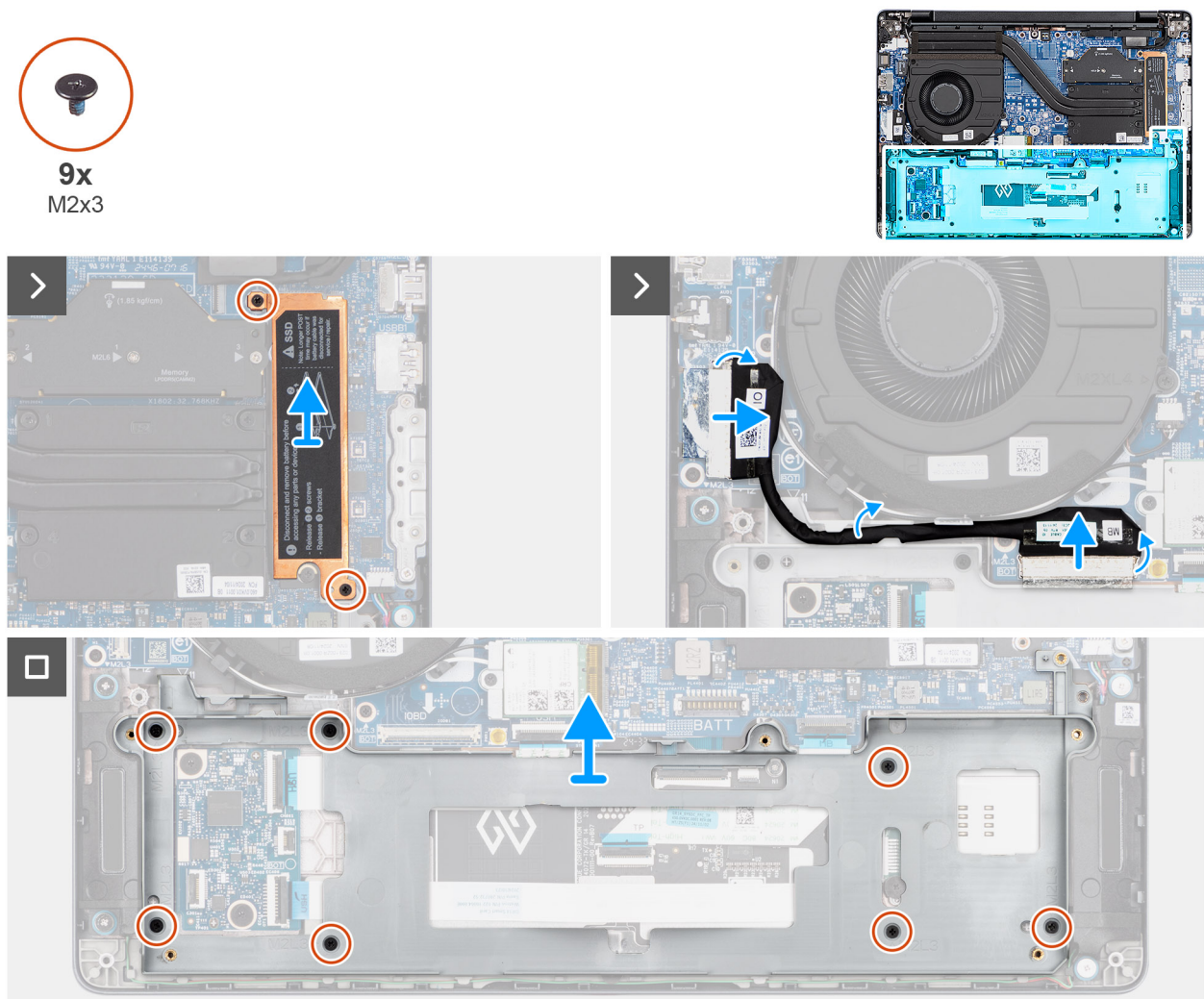


Figure 32. Removing the battery frame

### Steps

1. Remove the two screws (M2x3) that secure the SSD bracket to the system board.
2. Lift the SSD bracket off the system board.

**NOTE:** Only the SSD bracket is to be removed. The M.2 solid state drive is not required to be removed for the removal of the battery frame.

3. Disconnect the I/O-board cable from the connector (IOBD) on the system board.
4. Disconnect the I/O-board cable from the connector (CN1) on the I/O board.
5. Remove the I/O-board cable from the routing guides on the battery frame and lift the I/O-board cable off the battery frame.
6. Remove the seven screws (M2x3) that secure the battery frame to the palm-rest assembly.
7. Lift the battery frame off the palm-rest assembly.

## Installing the battery frame

**CAUTION:** The information in this installation section is intended for authorized service technicians only.

### Prerequisites

If you are replacing a component, remove the existing component before performing the installation procedure.

### About this task

The following images indicate the location of the battery frame and provide a visual representation of the installation procedure.

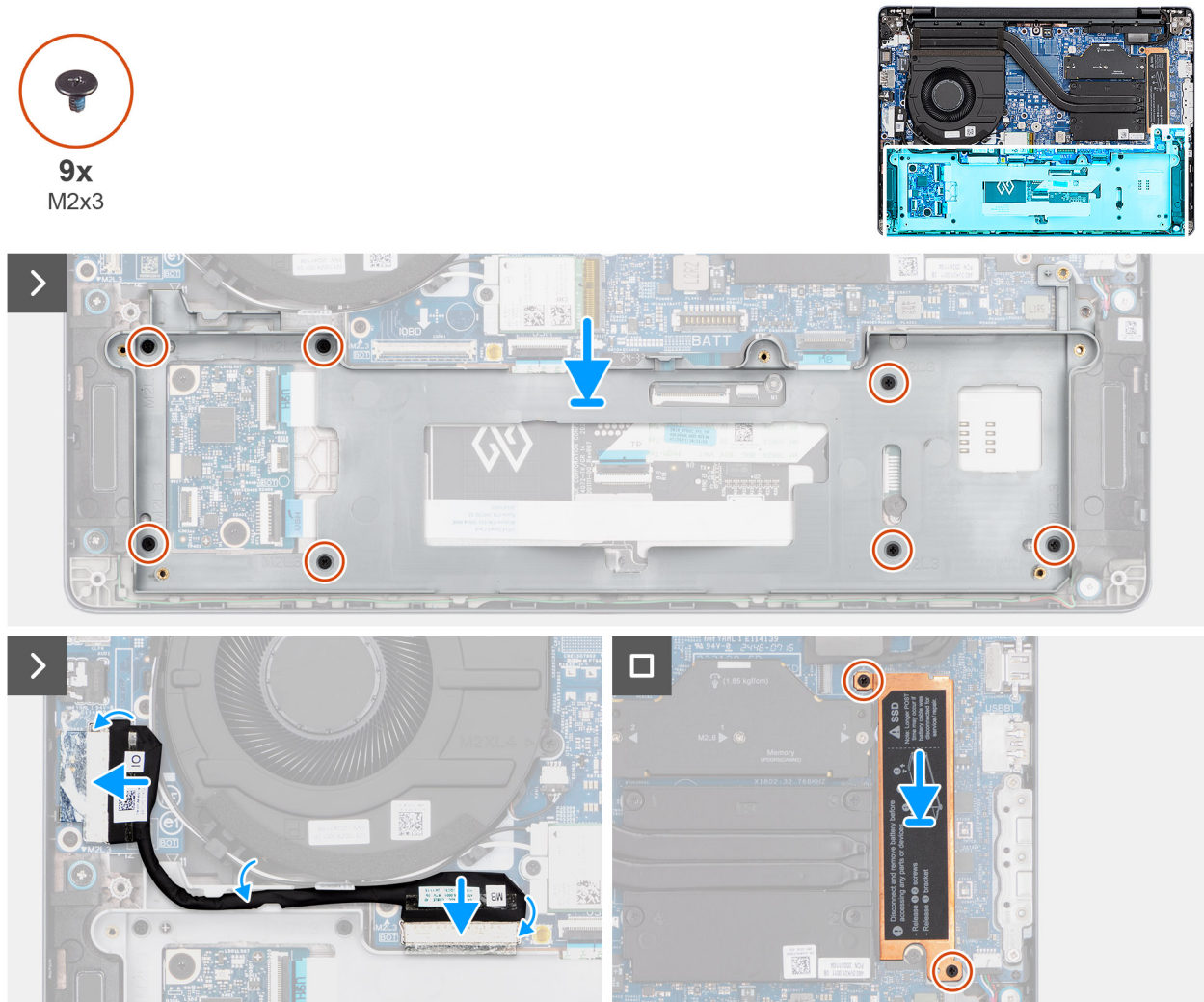


Figure 33. Installing the battery frame

### Steps

1. Align and place the battery frame in the slot on the palm-rest assembly.
2. Replace the seven screws (M2x3) to secure the battery frame to the palm-rest assembly.
3. Connect the I/O-board cable to the connector (IOBD) on the system board.
4. Connect the I/O-board cable to the connector (CN1) on the I/O board.
5. Route the I/O-board cable through the routing guides on the battery frame.
6. Align and place the SSD bracket on the solid state drive.
7. Replace the two screws (M2x3) to secure the SSD bracket to the system board.

### Next steps

1. Install the [battery](#).
2. Install the [base cover](#).
3. Follow the procedure in [After working inside your computer](#).

## USH board

### Removing the USH board

 **CAUTION:** The information in this removal section is intended for authorized service technicians only.

#### Prerequisites

1. Follow the procedure in [Before working inside your computer](#).
2. Remove the [base cover](#).
3. Remove the [battery](#).
4. Remove the [battery frame](#).

#### About this task

The following images indicate the location of the USH board and provide a visual representation of the removal procedure.





2x  
M2x2

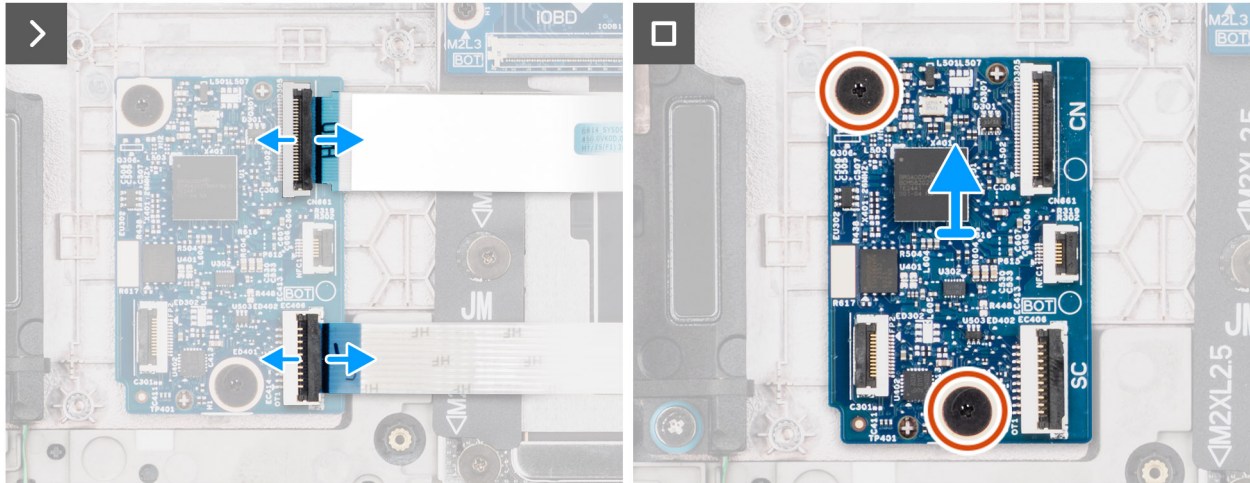
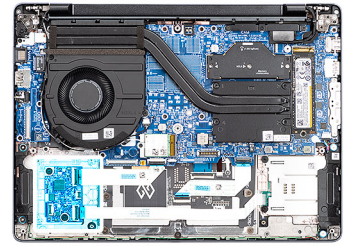


Figure 34. Removing the USH board

### Steps

1. Disconnect the USH-board cable from the connector (CN) on the USH board.
2. Disconnect the smart-card reader cable from the connector (SC) on the USH board.  
**i** **NOTE:** This step applies only to computers shipped with a smart-card reader installed.
3. Disconnect the NFC-sensor cable from the connector (NFC1) on the USH board.  
**i** **NOTE:** This step applies only to computers shipped with an NFC sensor installed.
4. Remove the two screws (M2x2) that secure the USH board to the palm-rest assembly.
5. Lift the USH board off the palm-rest assembly.

## Installing the USH board

**CAUTION:** The information in this installation section is intended for authorized service technicians only.

### Prerequisites

If you are replacing a component, remove the existing component before performing the installation procedure.

### About this task

The following images indicate the location of the USH board and provide a visual representation of the installation procedure.



2x  
M2x2

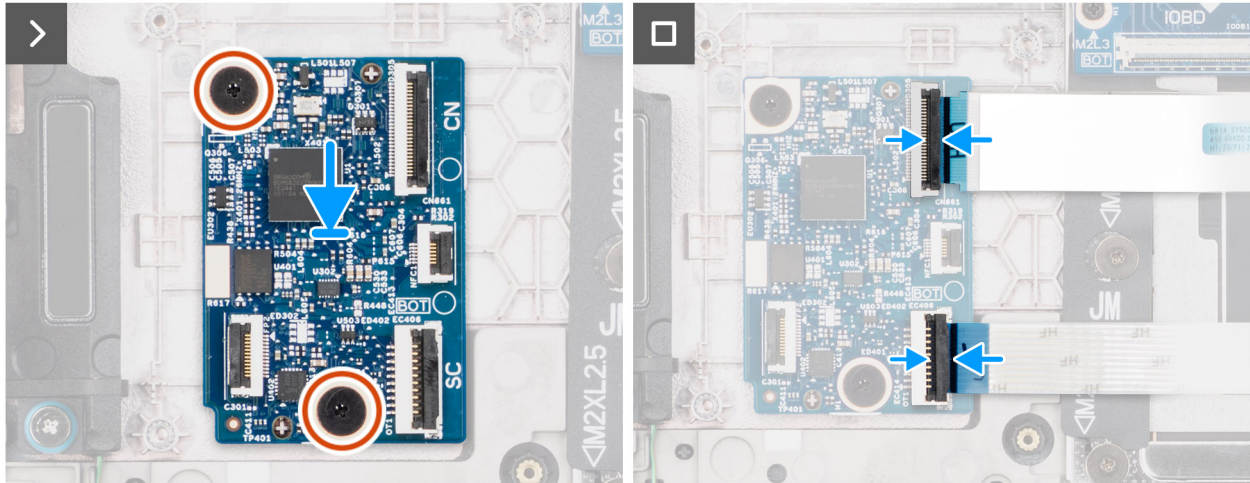
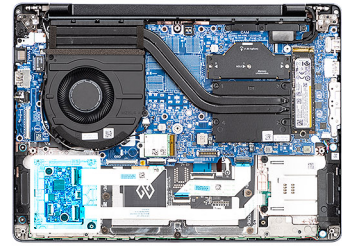


Figure 35. Installing the USH board

### Steps

1. Align and place the USH board in the slot on the palm-rest assembly.
2. Replace the two screws (M2x2) to secure the USH board to the palm-rest assembly.
3. Connect the USH-board cable to the connector (CN) on the USH board.
4. Connect the smart-card reader cable to the connector (SC) on the USH board.  
**i** **NOTE:** This step applies only to computers shipped with a smart-card reader installed.
5. Connect the NFC-sensor cable to the connector (NFC1) on the USH board.  
**i** **NOTE:** This step applies only to computers shipped with an NFC sensor installed.

### Next steps

1. Install the [battery frame](#).
2. Install the [battery](#).
3. Install the [base cover](#).
4. Follow the procedure in [After working inside your computer](#).

## Smart-card reader

### Removing the smart-card reader

**⚠ CAUTION:** The information in this removal section is intended for authorized service technicians only.

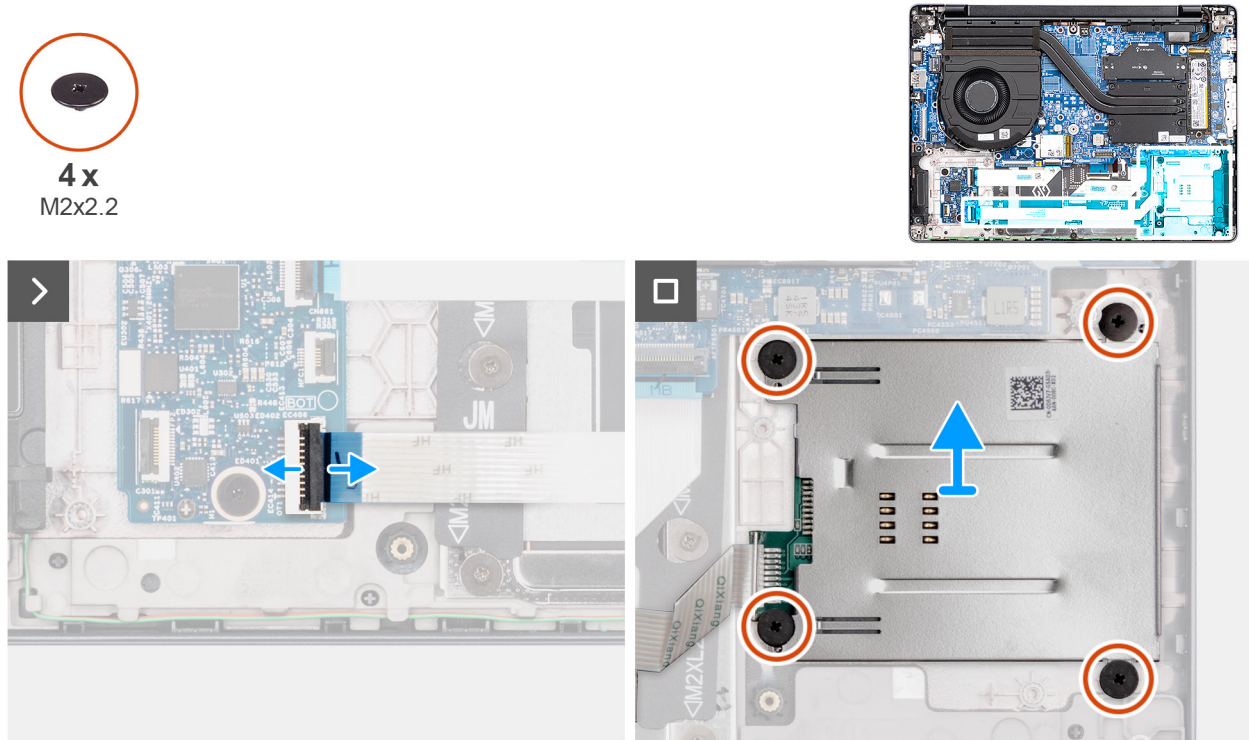
**i** **NOTE:** This procedure applies only to computers shipped with an NFC sensor or smart-card reader installed.

### Prerequisites

1. Follow the procedure in [Before working inside your computer](#).
2. Remove the [base cover](#).
3. Remove the [battery](#).
4. Remove the [battery frame](#).

### About this task

The following images indicate the location of the smart-card reader and provide a visual representation of the removal procedure.



**Figure 36. Removing the smart-card reader**

### Steps

1. Disconnect the NFC sensor or smart-card reader cable, whichever is applicable, from the connector (SC) on the USH board.
2. Remove the four screws (M2x2.2) that secure the smart-card reader to the palm-rest assembly.
3. Lift the smart-card reader off the palm-rest assembly.

## Installing the smart-card reader

**CAUTION:** The information in this installation section is intended for authorized service technicians only.

**NOTE:** This procedure applies only to computers shipped with an NFC sensor or smart-card reader installed.

### Prerequisites

If you are replacing a component, remove the existing component before performing the installation procedure.

### About this task

The following images indicate the location of the smart-card reader and provide a visual representation of the installation procedure.





4 x  
M2x2.2

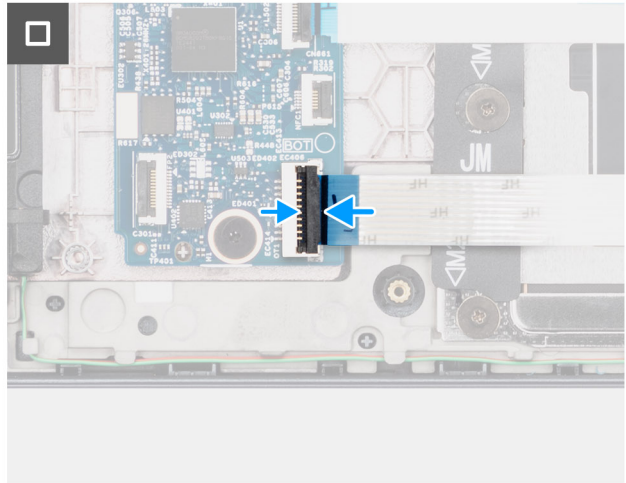
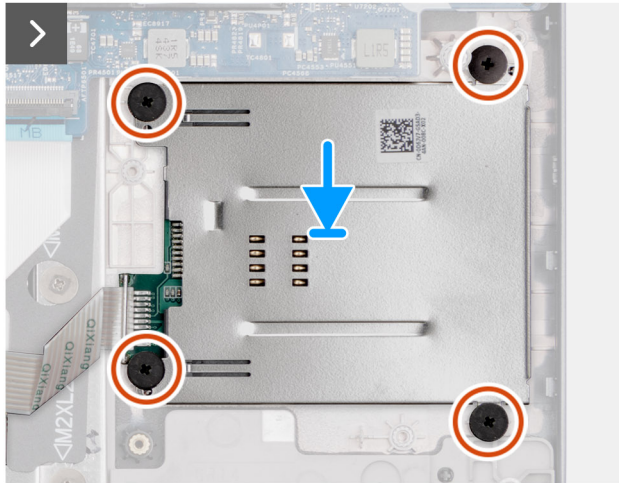
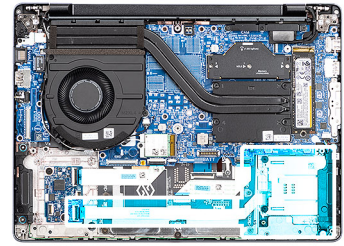


Figure 37. Installing the smart-card reader

#### Steps

1. Align and place the smart-card reader in the slot on the palm-rest assembly.
2. Replace the four screws (M2x2.2) to secure the smart-card reader to the palm-rest assembly.
3. Connect the NFC sensor or smart-card reader cable, whichever is applicable, to the connector (SC) on the USH board.

#### Next steps

1. Install the [battery frame](#).
2. Install the [battery](#).
3. Install the [base cover](#).
4. Follow the procedure in [After working inside your computer](#).

## Heat sink

### Removing the heat sink

**CAUTION:** The information in this removal section is intended for authorized service technicians only.

#### Prerequisites

1. Follow the procedure in [Before working inside your computer](#).
2. Remove the [base cover](#).

#### About this task

**NOTE:** The heat sink may become hot during normal operation. Allow sufficient time for the heat sink to cool before you touch it.

**NOTE:** For optimal cooling of the processor, do not touch the heat-transfer areas on the heat sink. The oils in your skin can reduce the heat-transfer capability of the thermal grease.

The following image indicates the location of the heat sink and provides a visual representation of the removal procedure.

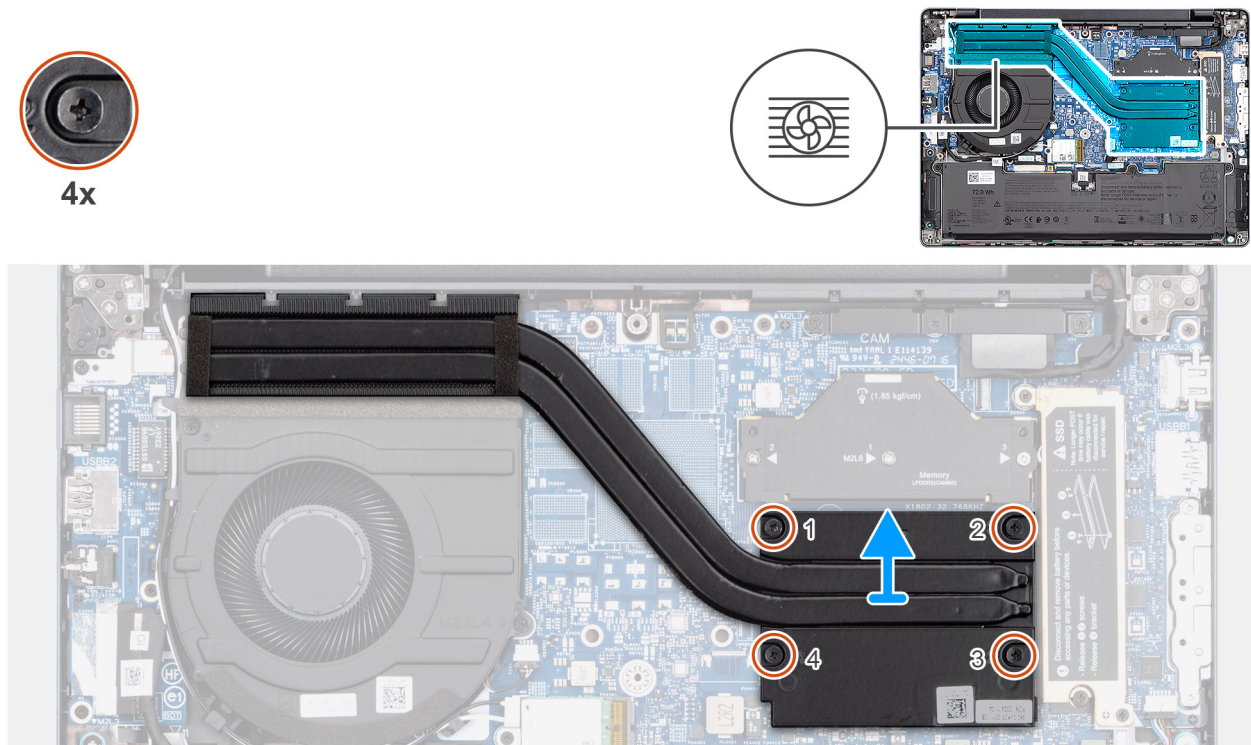


Figure 38. Removing the heat sink

### Steps

1. In reverse sequential order (4 > 3 > 2 > 1), loosen the four captive screws that secure the heat sink to the system board. The screw numbers are etched on the heat sink.
2. Lift the heat sink off the system board.

## Installing the heat sink

**CAUTION:** The information in this installation section is intended for authorized service technicians only.

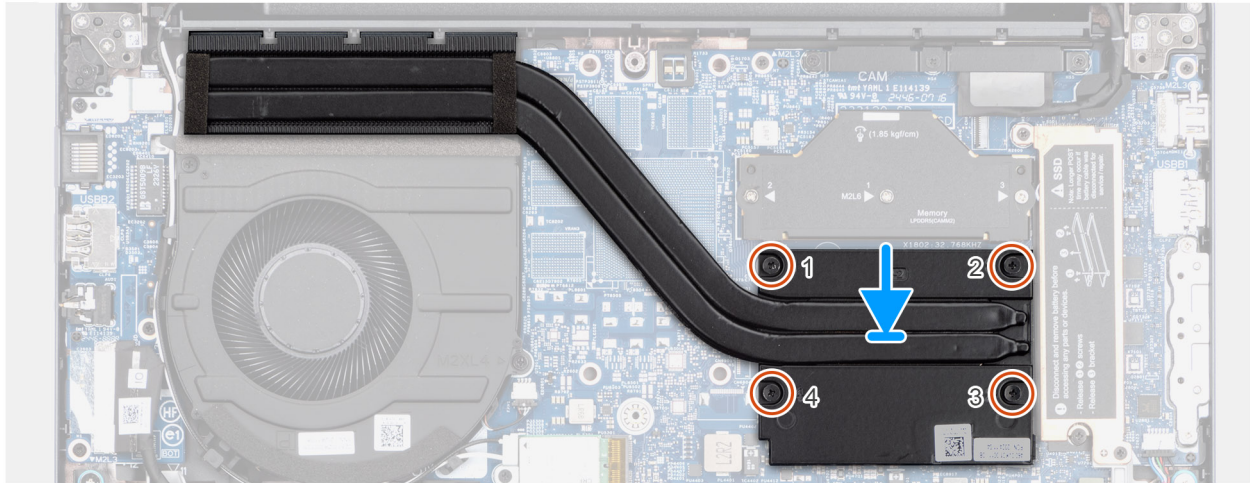
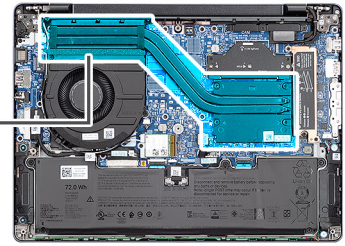
### Prerequisites

If you are replacing a component, remove the existing component before performing the installation procedure.

### About this task

**NOTE:** If either the system board or the heat sink is replaced, use the thermal grease that is provided in the kit to ensure that thermal conductivity is achieved.

The following image indicates the location of the heat sink and provides a visual representation of the installation procedure.



**Figure 39. Installing the heat sink**

### Steps

1. Place the heat sink in the slot on the system board.
2. Align the screw holes on the heat sink with the screw holes on the system board.
3. In sequential order (1 > 2 > 3 > 4), tighten the four captive screws to secure the heat sink to the system board. The screw numbers are etched on the heat sink.

### Next steps

1. Install the [base cover](#).
2. Follow the procedure in [After working inside your computer](#).

## I/O board

### Removing the I/O board

**CAUTION:** The information in this removal section is intended for authorized service technicians only.

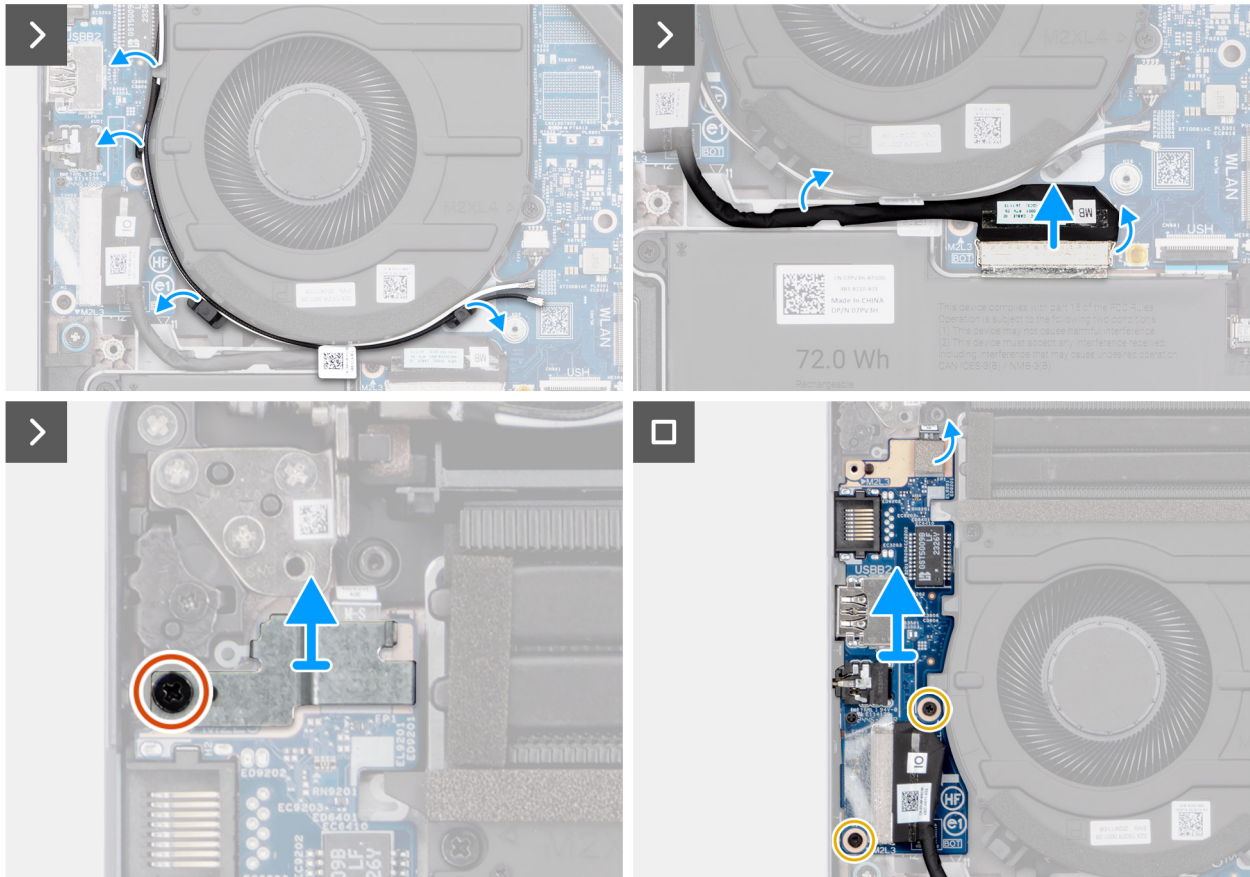
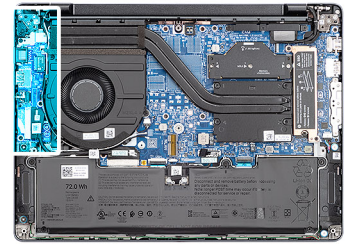
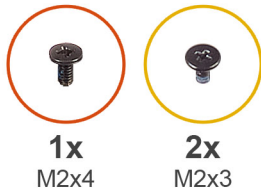
### Prerequisites

1. Follow the procedure in [Before working inside your computer](#).
2. Remove the [base cover](#).
3. Remove the [wireless card](#).

### About this task

The following images indicate the location of the I/O board and provide a visual representation of the removal procedure.





**Figure 40. Removing the I/O board**

### Steps

1. Remove the wireless-antenna cables from the routing guides on the fan.
  2. Disconnect the I/O-board cable from the connector (IOBD) on the system board.
  3. Remove the I/O-board cable from the routing guides on the battery frame.
  4. Remove the screw (M2x4) that secures the fingerprint-reader bracket to the palm-rest assembly.
  5. Lift the fingerprint-reader bracket off the I/O board.
  6. Disconnect the fingerprint-reader cable from the connector (FP1) on the I/O board.
- NOTE:** This step applies only to computers shipped with a fingerprint reader installed.
7. Remove the two screws (M2x3) that secure the I/O board to the palm-rest assembly.
  8. Carefully slide and remove the I/O board at angle from the palm-rest assembly.

## Installing the I/O board

**CAUTION:** The information in this installation section is intended for authorized service technicians only.

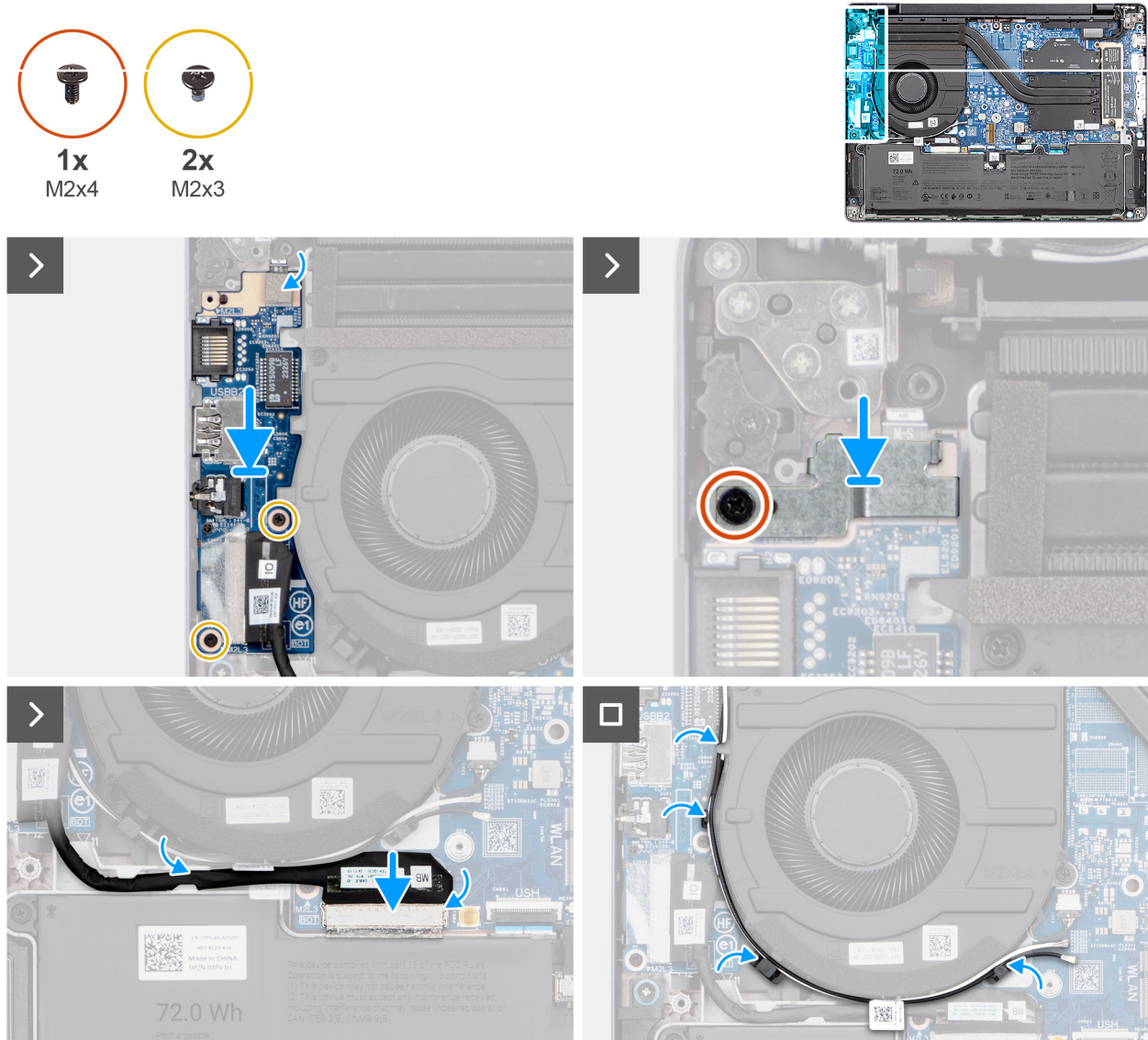


## Prerequisites

If you are replacing a component, remove the existing component before performing the installation procedure.

## About this task

The following images indicate the location of the I/O board and provide a visual representation of the installation procedure.



**Figure 41. Installing the I/O board**

## Steps

1. Align the ports on the I/O board with the port slots and place the I/O board on the palm-rest assembly.
2. Align the screw holes on the I/O board with the screw holes on the palm-rest assembly.
3. Replace the two screws (M2x3) to secure the I/O board to the palm-rest assembly.
4. Connect the fingerprint-reader cable to the connector (FP1) on the I/O board.

**NOTE:** This step applies only to computers shipped with a fingerprint reader installed.

5. Align and place the fingerprint-reader bracket over the fingerprint-reader connector on the I/O board.
6. Replace the screw (M2x4) to secure the fingerprint-reader bracket to the palm-rest assembly.
7. Connect the I/O-board cable to the connector (IOBD) on the system board.
8. Route the I/O-board cable through the routing guides on the battery frame.

9. Route the wireless-antenna cables through the routing guides on the fan.

### Next steps

1. Install the [wireless card](#).
2. Install the [base cover](#).
3. Follow the procedure in [After working inside your computer](#).

## Power button

### Removing the power button

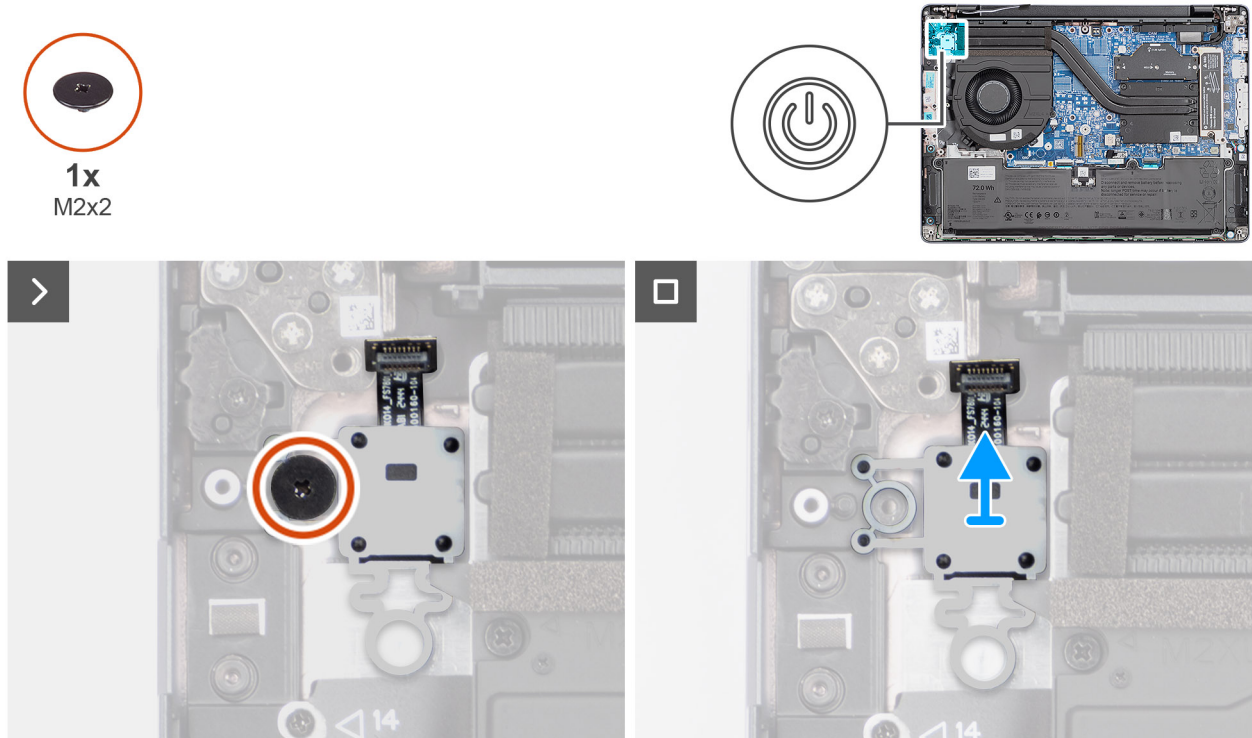
**CAUTION:** The information in this removal section is intended for authorized service technicians only.

#### Prerequisites

1. Follow the procedure in [Before working inside your computer](#).
2. Remove the [base cover](#).
3. Remove the [wireless card](#).
4. Remove the [I/O board](#).

#### About this task

The following images indicate the location of the power button and provide a visual representation of the removal procedure.



**Figure 42. Removing the power button**

#### Steps

1. Remove the screw (M2x2) that secures the power button to the palm-rest assembly.
2. Lift the power button off the slot on the palm-rest assembly.

## Installing the power button

**CAUTION:** The information in this installation section is intended for authorized service technicians only.

### Prerequisites

If you are replacing a component, remove the existing component before performing the installation procedure.

### About this task

The following images indicate the location of the power button and provide a visual representation of the installation procedure.

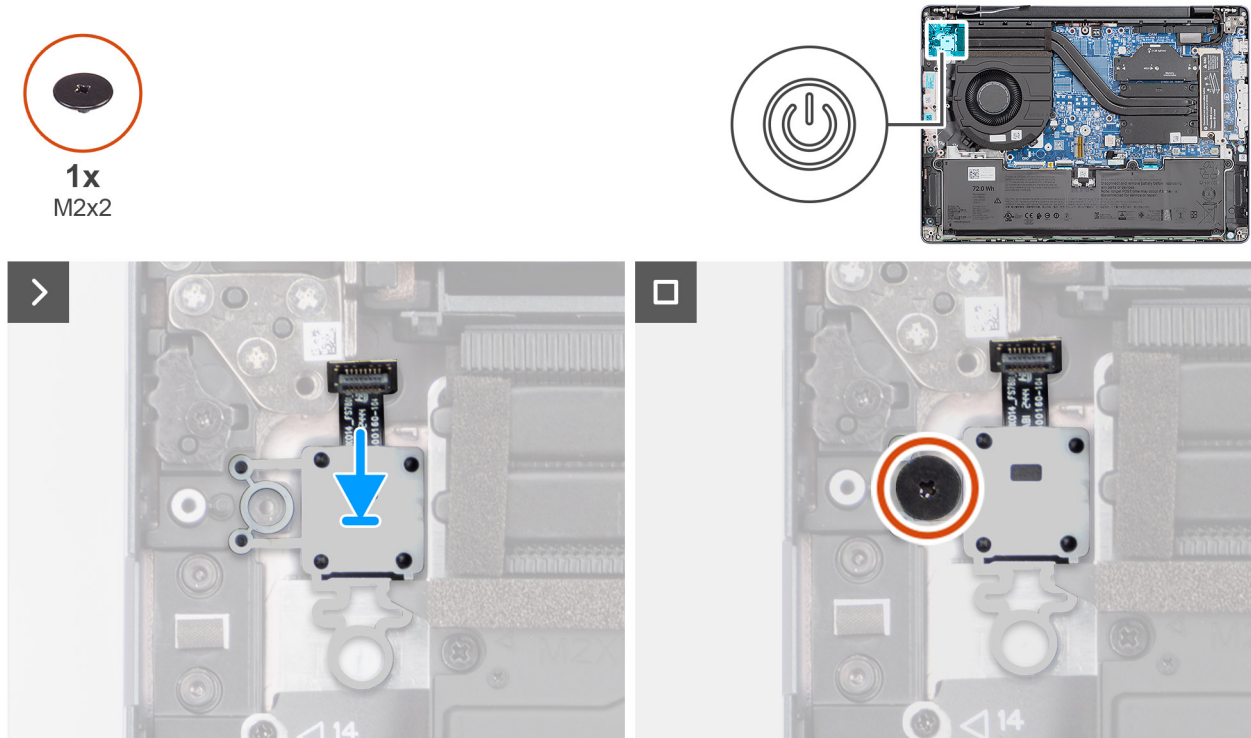


Figure 43. Installing the power button

### Steps

1. Place the power button in the slot on the palm-rest assembly.
2. Align the screw hole on the power button with the screw hole on the palm-rest assembly.
3. Replace the screw (M2x2) to secure the power button to the palm-rest assembly.

### Next steps

1. Install the [I/O board](#).
2. Install the [wireless card](#).
3. Install the [base cover](#).
4. Follow the procedure in [After working inside your computer](#).

## Display assembly

### Removing the display assembly

**CAUTION:** The information in this removal section is intended for authorized service technicians only.



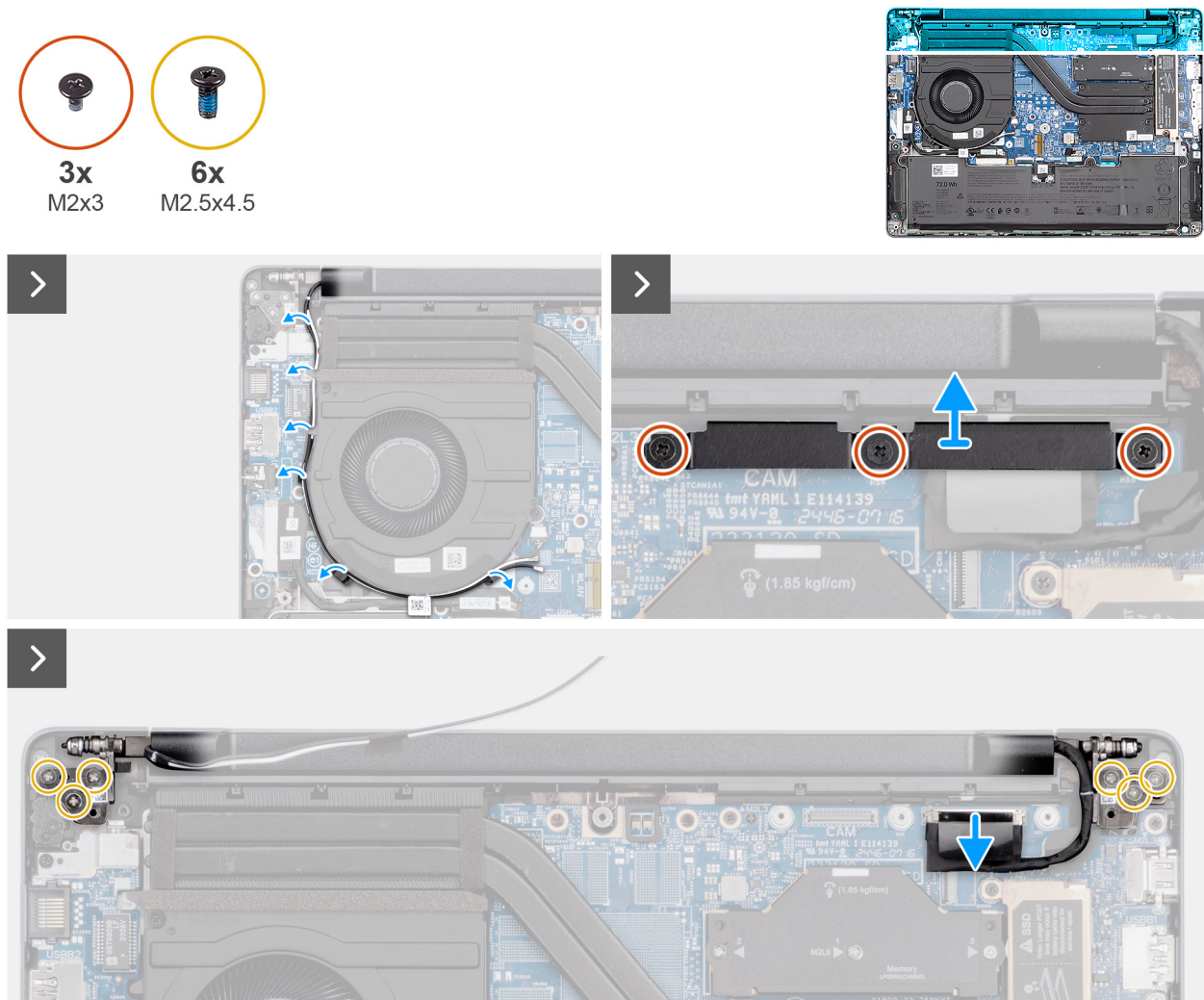
**CAUTION:** The maximum operating angle for the display-panel hinge is 135 degrees.

### Prerequisites

1. Follow the procedure in [Before working inside your computer](#).
2. Remove the [base cover](#).
3. Remove the [wireless card](#).

### About this task

The following images indicate the location of the display assembly and provide a visual representation of the removal procedure.



**Figure 44. Removing the display assembly**

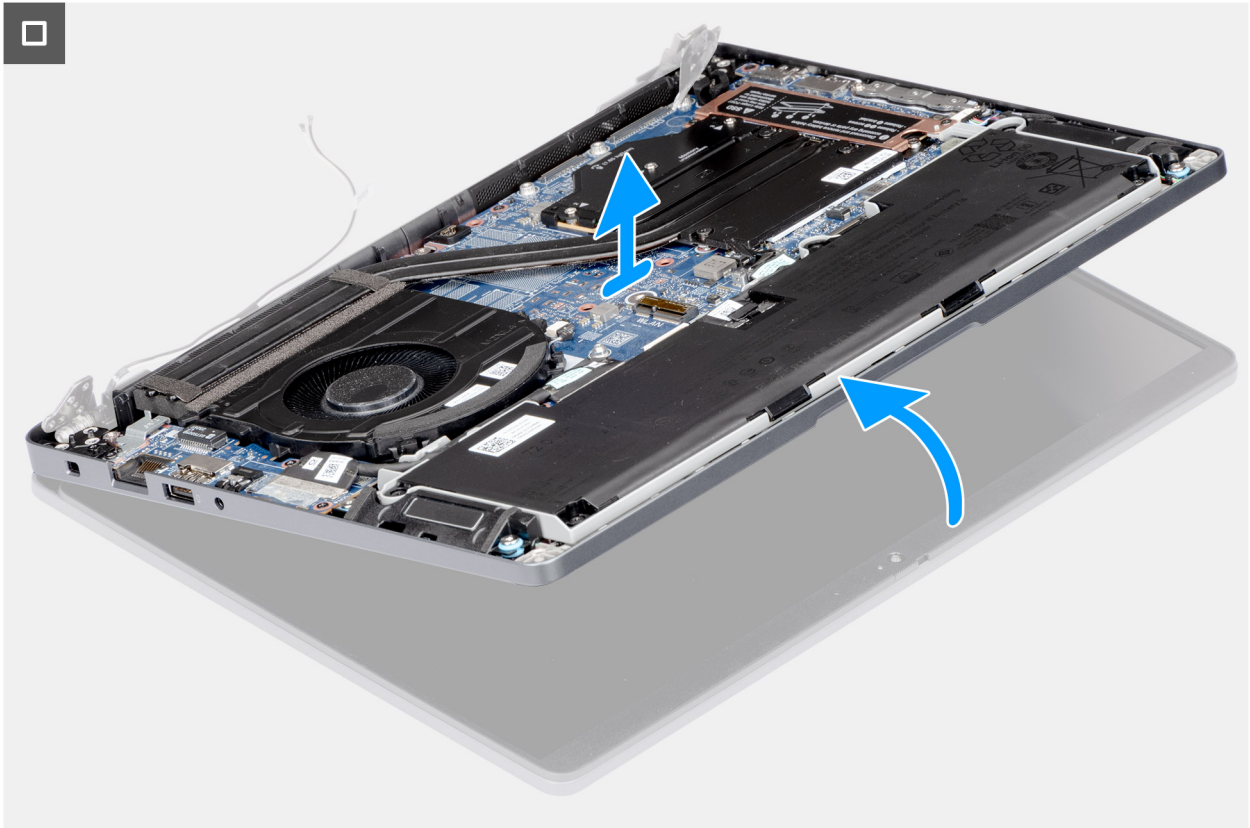


Figure 45. Removing the display assembly



**Figure 46. Display assembly**

### Steps

1. Remove the wireless-antenna cables from the routing guides on the fan.
2. Remove the three screws (M2x3) that secure the display-cable bracket to the system board.
3. Lift the display-cable bracket off the system board.
4. Disconnect the display cable from the connector (LCD) on the system board.
5. Disconnect the IR-camera cable from the connector (CAM) on the system board.

**i** **NOTE:** This step applies only to computers shipped with an IR camera installed.

6. Remove the six screws (M2.5x4.5) that secure the display hinges to the palm-rest assembly.
7. Using a plastic scribe, lift the left and right hinges to an angle of 90 degrees from the palm-rest assembly.
8. Lift the palm-rest assembly at an angle to free it from the hinges and remove it from the display assembly.

**⚠ CAUTION:** To avoid damaging the display, do not slide the palm-rest assembly over the display assembly.

## Installing the display assembly

**⚠ CAUTION:** The information in this installation section is intended for authorized service technicians only.

**⚠ CAUTION:** The maximum operating angle for the display-panel hinge is 135 degrees.

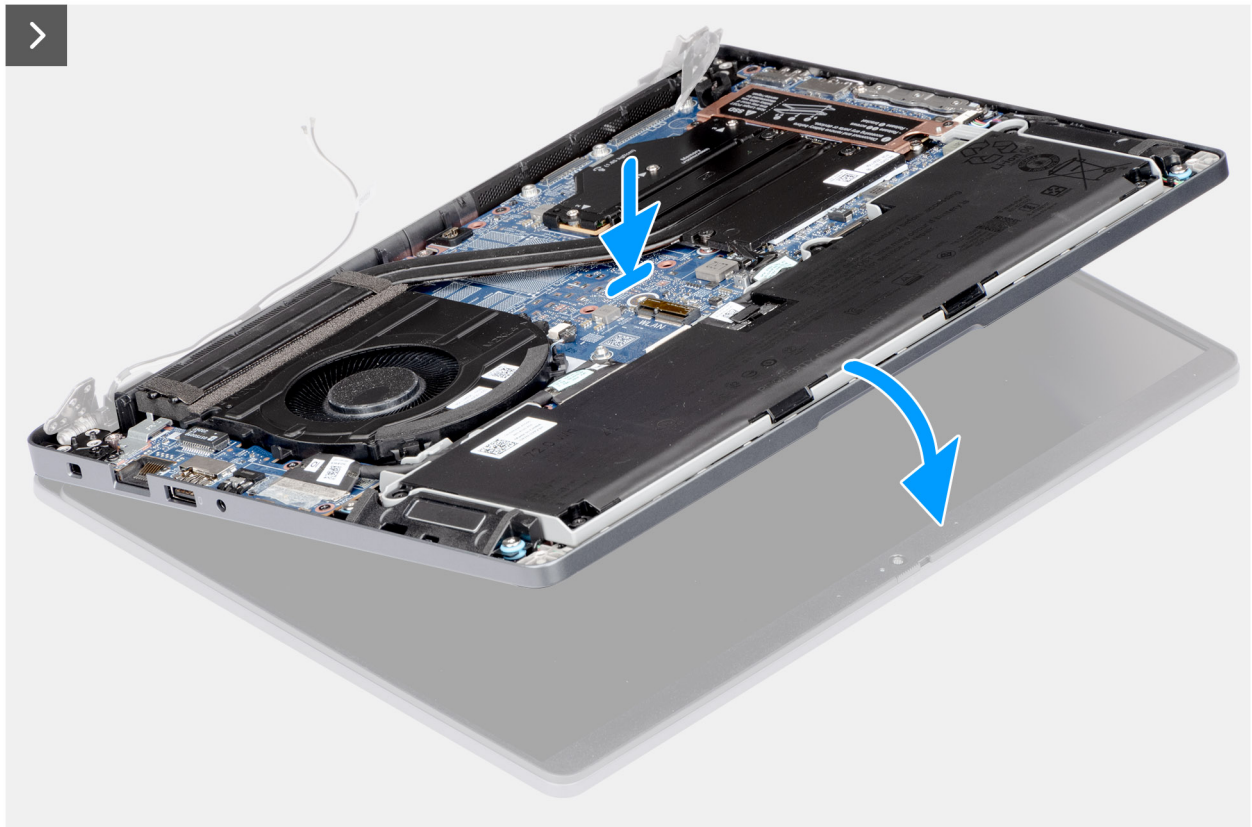
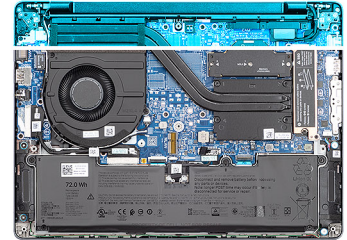
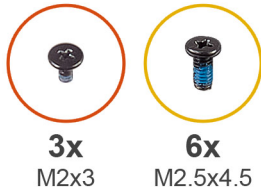
### Prerequisites

If you are replacing a component, remove the existing component before performing the installation procedure.

**About this task**

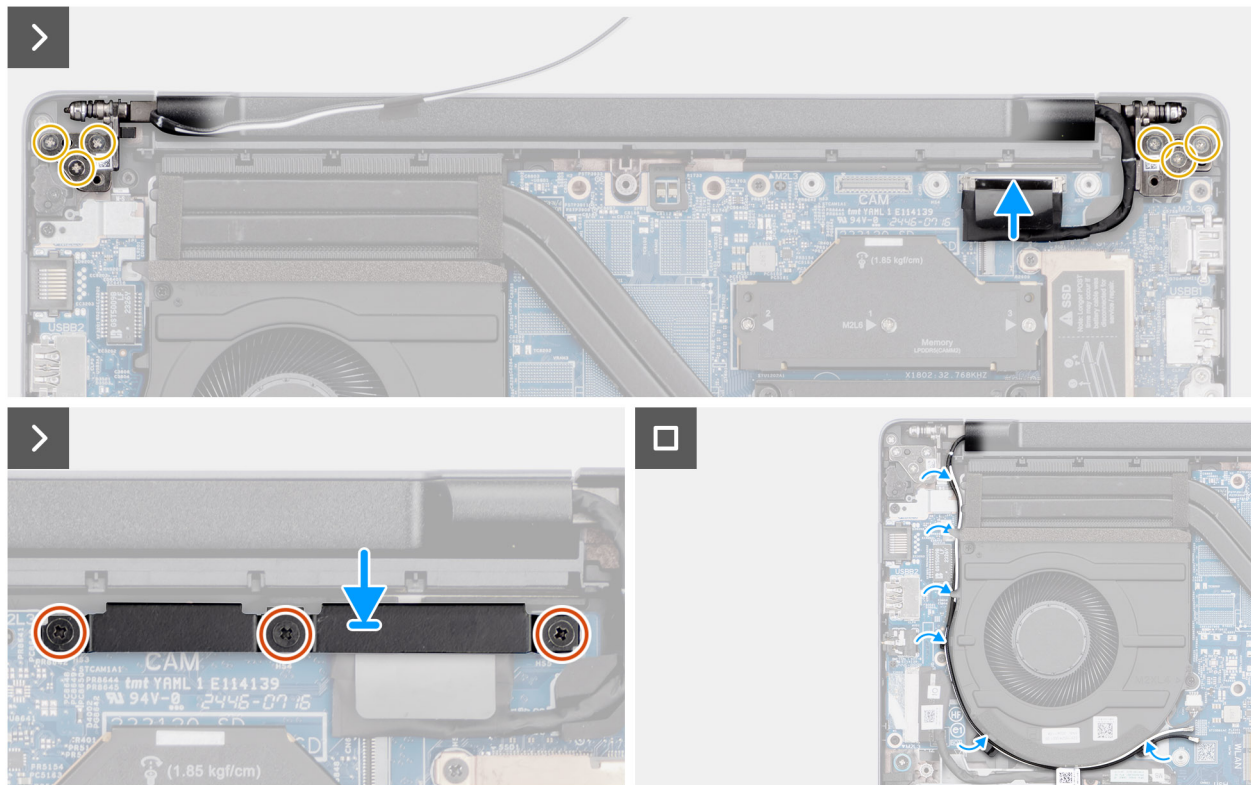
**NOTE:** Ensure that the display hinges are opened to the maximum before replacing the display assembly on the palm-rest assembly.

The following images indicate the location of the display assembly and provide a visual representation of the installation procedure.



**Figure 47. Installing the display assembly**





**Figure 48. Installing the display assembly**

**Steps**

1. Place the display assembly on a clean and flat surface.
2. Hold the palm-rest assembly at an angle and slide the palm-rest assembly under the display hinges.
  - CAUTION:** To avoid damaging the display, do not slide the palm-rest assembly over the display assembly.
3. Close the display hinges to align the screw holes on the display hinges with the screw holes on the palm-rest assembly.
4. Replace the six screws (M2.5x4.5) to secure the display hinges to the palm-rest assembly.
5. Connect the display cable to the connector (LCD) on the system board.
6. Connect the IR-camera cable to the connector (CAM) on the system board.
  - NOTE:** This step applies only to computers shipped with an IR camera installed.
7. Align and place the display-cable bracket over the display cable and the IR-camera cable, if available, on the system board.
8. Replace the three screws (M2x3) to secure the display-cable bracket to the system board.
9. Route the wireless-antenna cables through the routing guides on the fan.

**Next steps**

1. Install the [wireless card](#).
2. Install the [base cover](#).
3. Follow the procedure in [After working inside your computer](#).

## Display bezel


### Removing the display bezel

**CAUTION:** The information in this removal section is intended for authorized service technicians only.

### Prerequisites

1. Follow the procedure in [Before working inside your computer](#).
2. Remove the [base cover](#).
3. Remove the [wireless card](#).
4. Remove the [display assembly](#).

### About this task

 **NOTE:** The display-hinge caps are a part of the display bezel.

The following image indicates the location of the display bezel and provides a visual representation of the removal procedure.



**Figure 49. Removing the display bezel**

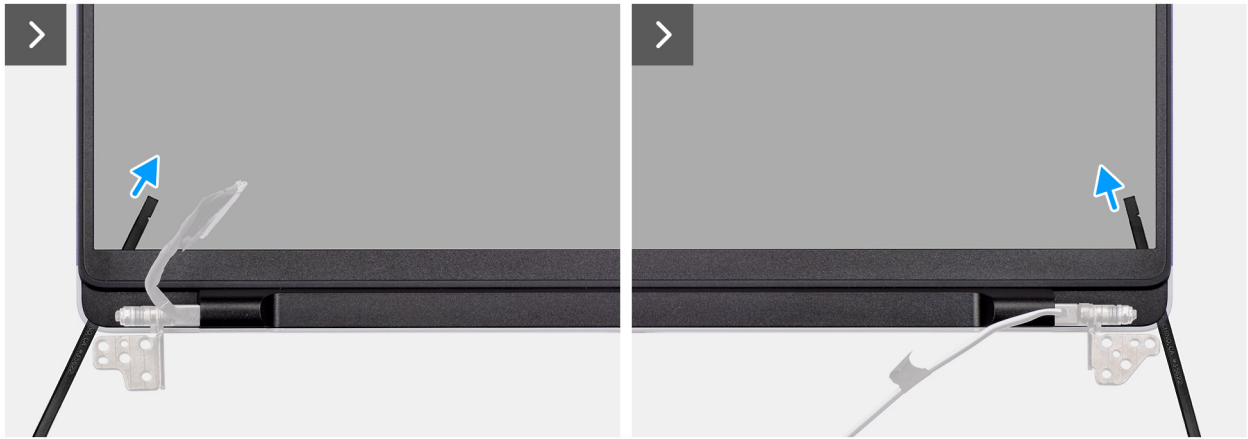


Figure 50. Removing the display bezel

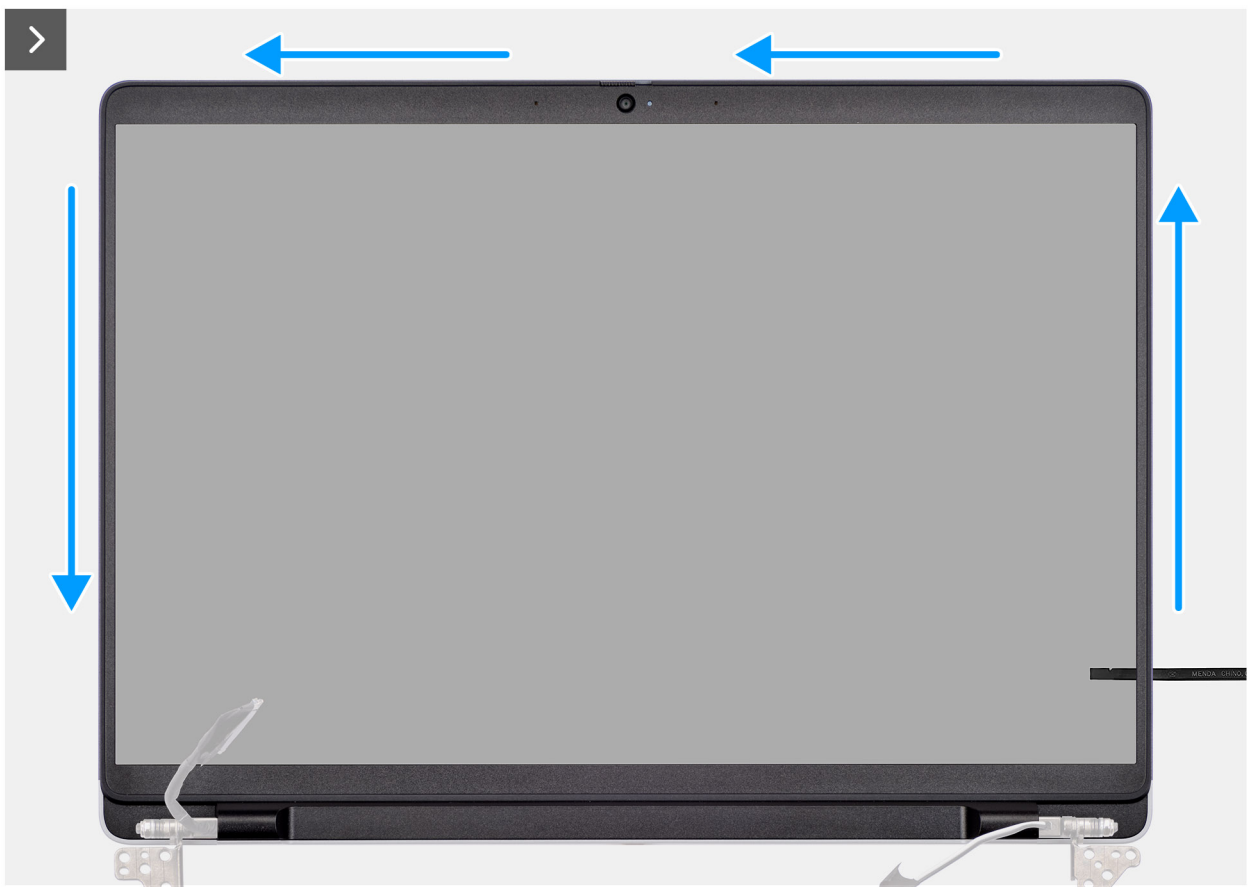


Figure 51. Removing the display bezel

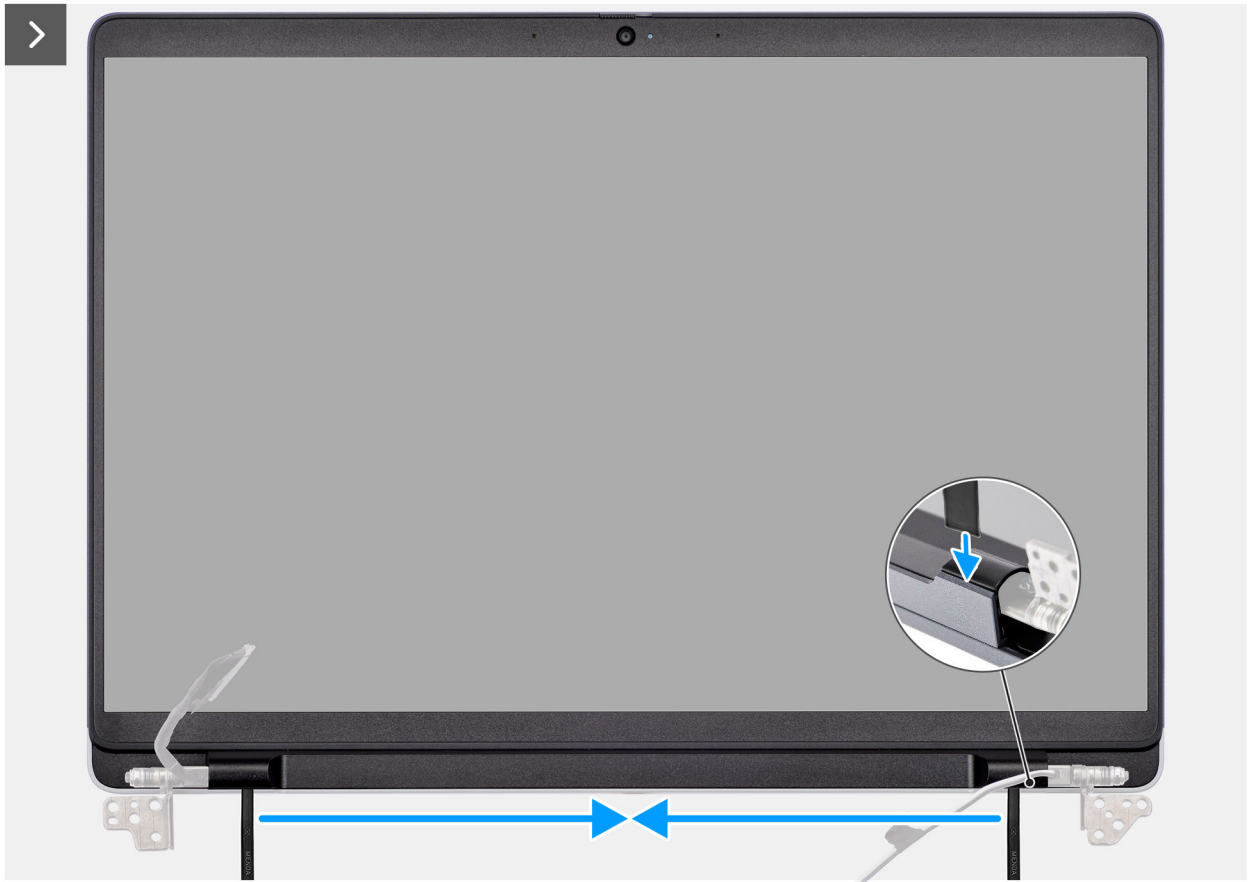


Figure 52. Removing the display bezel

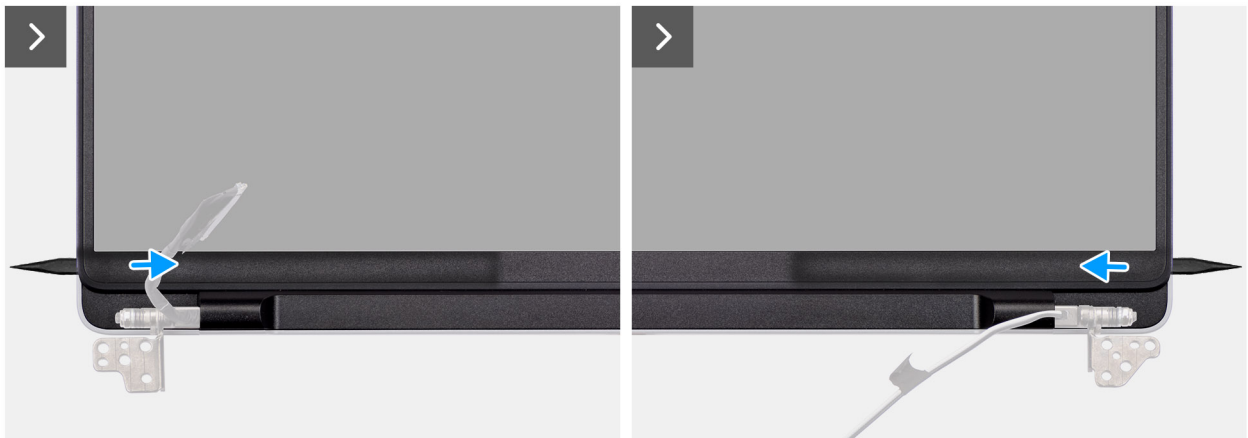
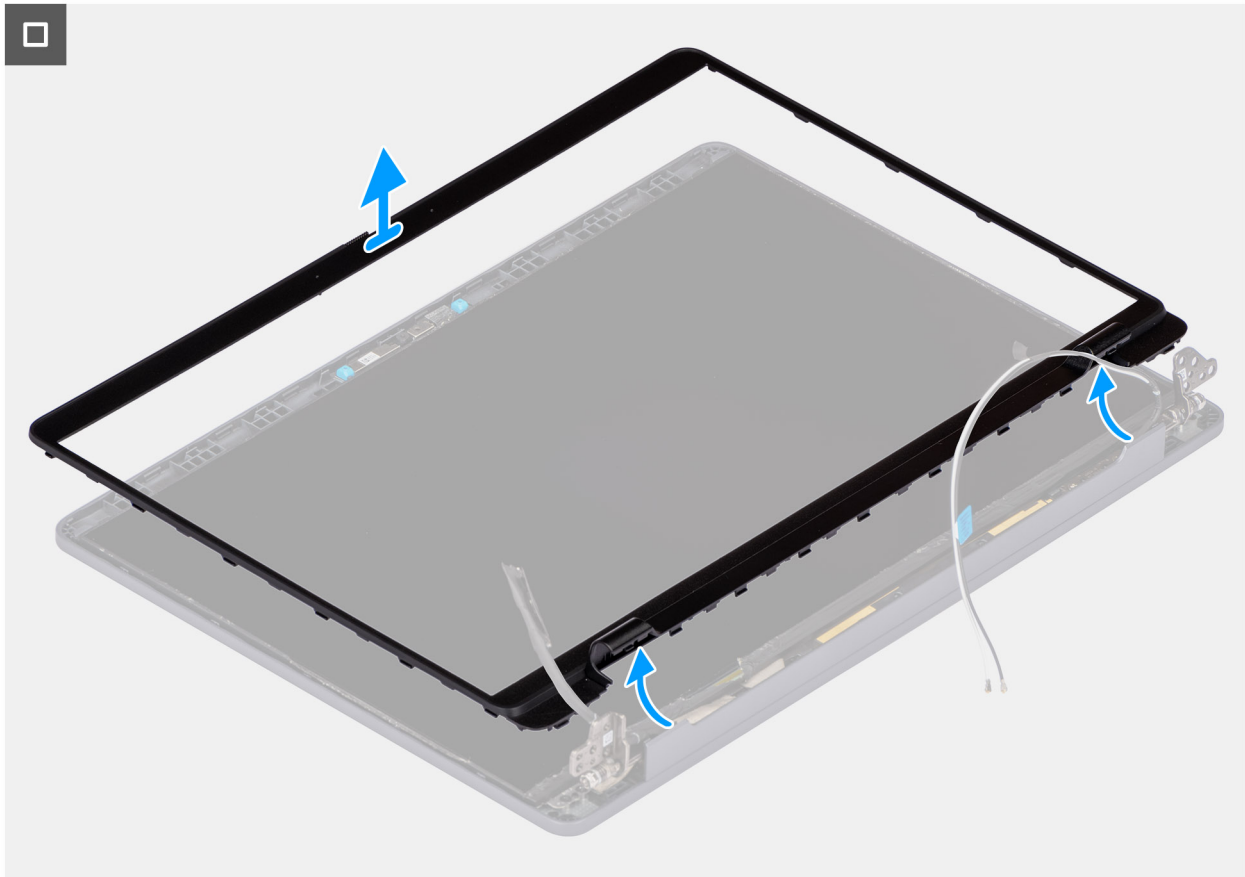


Figure 53. Removing the display bezel



**Figure 54. Removing the display bezel**

### Steps

1. Place the display assembly on a clean, flat surface and gently open the display hinges to at least 90 degrees.
2. At an angle, insert a flat-head slotted screwdriver (maximum width: 4 mm) into the slots on the bottom edge of the display bezel, near the display hinges. Then gently pry open the display bezel at both ends, near the hinges.

**NOTE:** The display bezel may get damaged during this step. If this happens, replace the display bezel with a new one.

3. **CAUTION:** Do not use the flat-head slotted screwdriver to pry open the rest of the display bezel. Instead, use a plastic scribe to continue prying along the display bezel.

**CAUTION:** When inserting the plastic scribe under the display bezel, ensure that it is parallel to the display panel. Pressing it down can damage the display panel.

Carefully insert a plastic scribe into the openings near the right display hinge, parallel to the display panel, to release the display bezel from the display.

4. Repeat step 4 near the left display hinge to release the display bezel from the display.
5. Keeping the plastic scribe parallel to the display panel, pry open the left, right, and top edges of the display bezel and carefully release it from the latches and adhesive on the display assembly.
6. Carefully insert the plastic scribe into the display-hinge cap at an angle of 90 degrees and pry open the display-hinge cap.
7. Keeping the plastic scribe at an angle of 90 degrees to the display panel, continue prying the bottom edge of the display bezel by sliding the scribe across the bottom edge and release it from the latches and adhesive on the display assembly.
8. Keeping the plastic scribe parallel to the right display hinge, insert the plastic scribe into the display bezel from the right edge. Then, carefully release the bezel, above the right display hinge, from the latches and adhesive on the display panel.
9. Repeat step 8 to release the display bezel above the left display hinge.
10. Lift the bezel to an angle of 15 degrees and gently pry along the middle part of the bottom edge and release the bezel from the latches and adhesive on the display panel.

11. Once all edges are released, carefully lift the display bezel off the display assembly.

## Installing the display bezel

**CAUTION:** The information in this installation section is intended for authorized service technicians only.

### Prerequisites

If you are replacing a component, remove the existing component before performing the installation procedure.

### About this task

**NOTE:** The display-hinge caps are a part of the display bezel.

The following images indicate the location of the display bezel and provide a visual representation of the installation procedure.

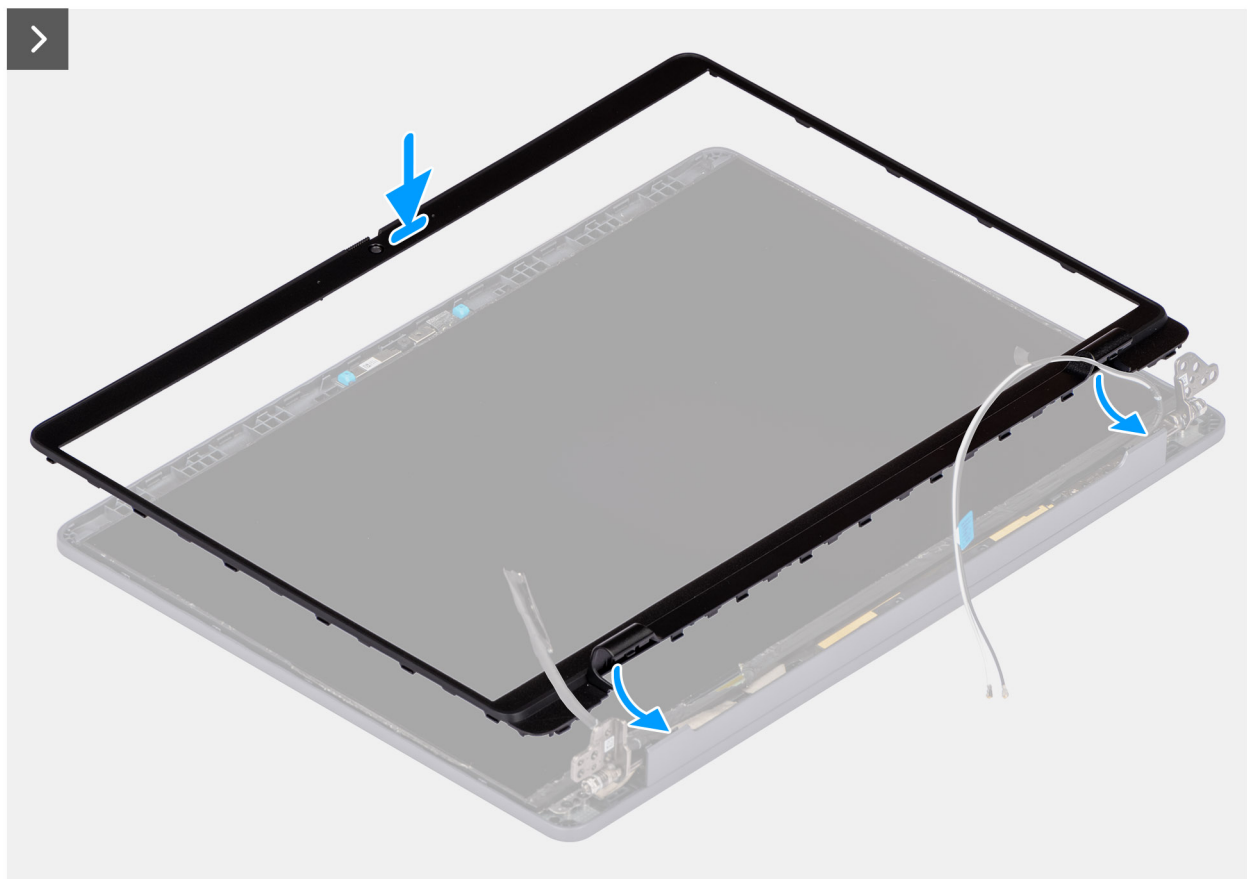
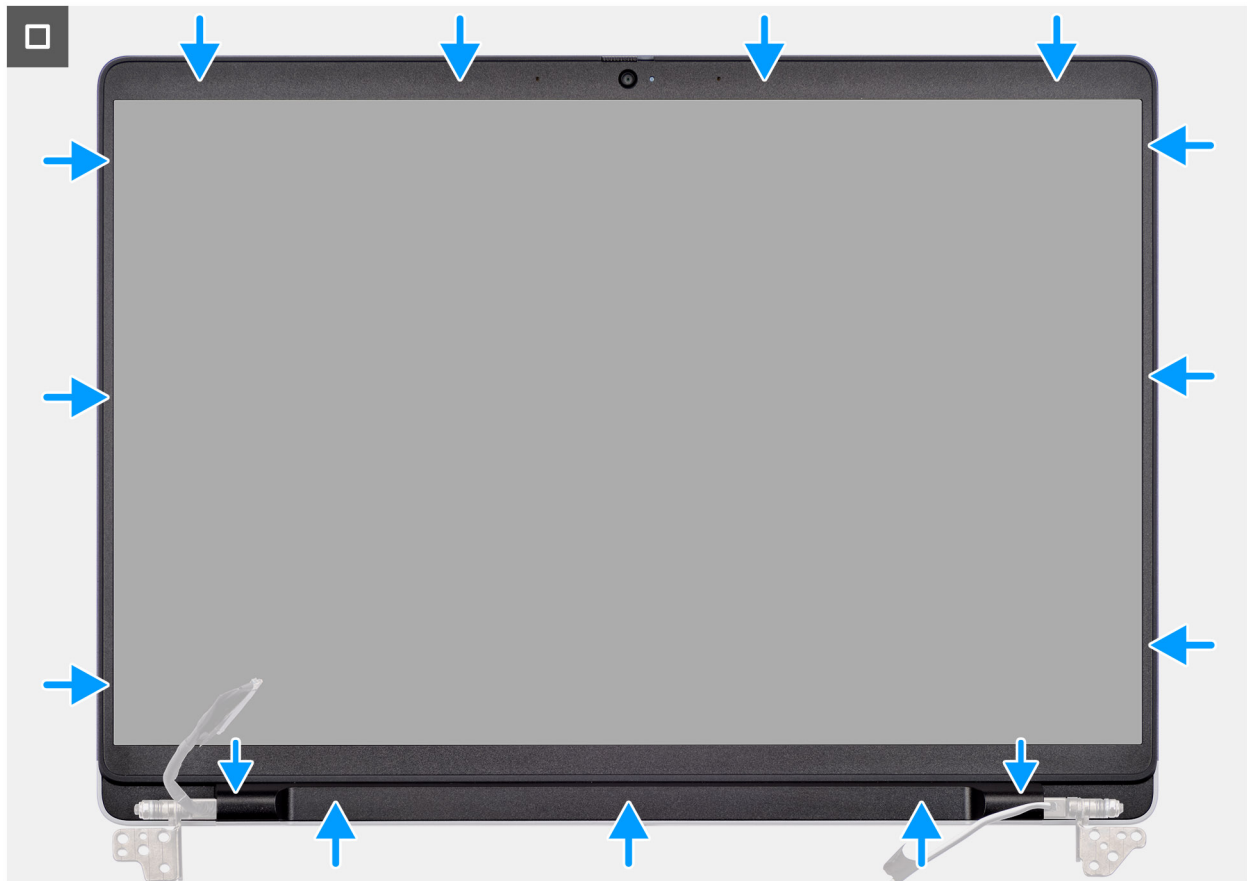


Figure 55. Installing the display bezel





**Figure 56. Installing the display bezel**

#### Steps

1. Place the display assembly on a clean and flat surface.
2. Align and place the display bezel on the display assembly.
3. Route the display cable and wireless-antenna cables through the respective display-hinge caps.
4. Press the display-hinge caps down on the display hinges, until they click in place.
5. Starting from the bottom corner, press the display bezel and work around the entire bezel until it snaps onto the display assembly.

#### Next steps

1. Install the [display assembly](#).
2. Install the [wireless card](#).
3. Install the [base cover](#).
4. Follow the procedure in [After working inside your computer](#).

## Display panel

### Removing the display panel

 **CAUTION:** The information in this removal section is intended for authorized service technicians only.

#### Prerequisites

1. Follow the procedure in [Before working inside your computer](#).
2. Remove the [base cover](#).



3. Remove the [wireless card](#).
4. Remove the [display assembly](#).
5. Remove the [display bezel](#).

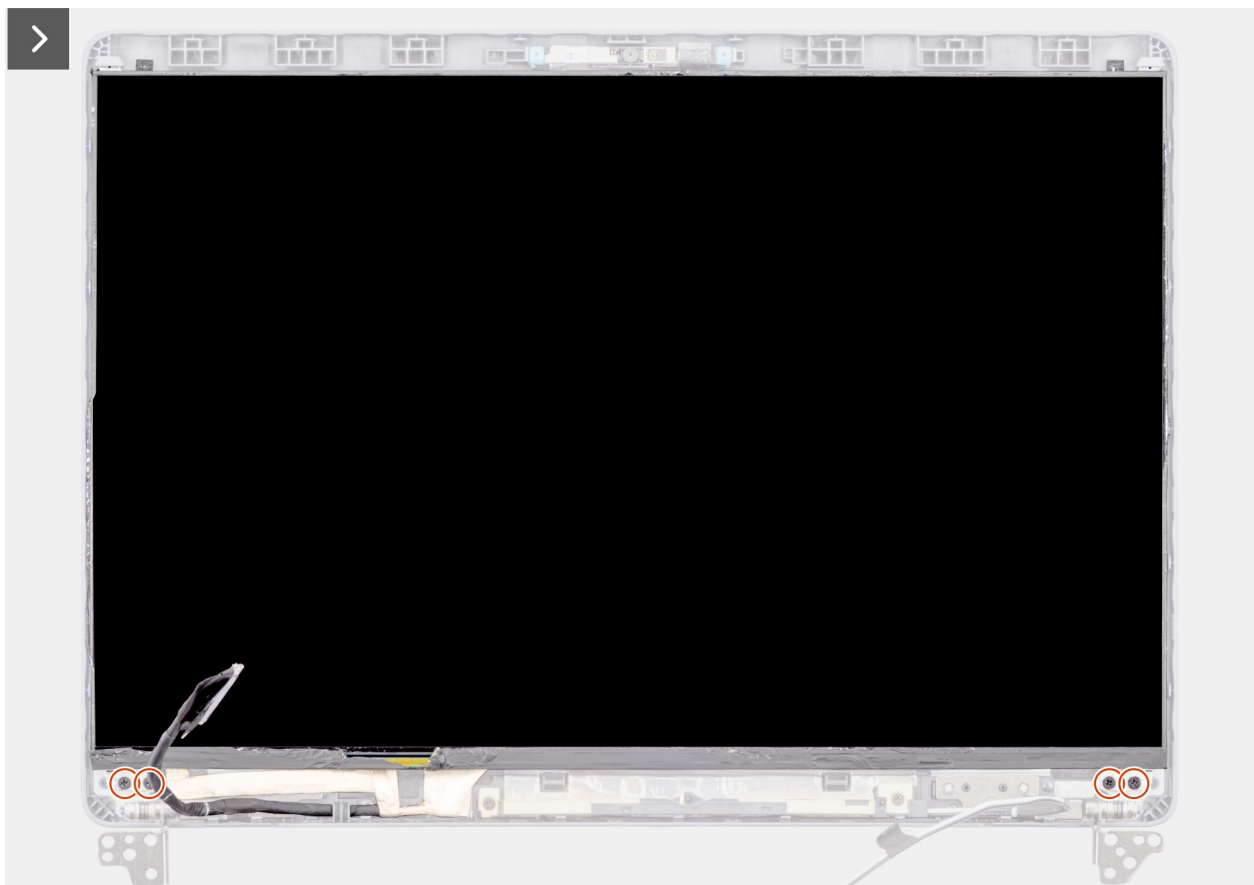
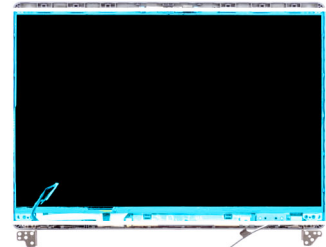
**About this task**

**NOTE:** The display panel is assembled with the display-panel brackets as a single service part.

The following images indicate the location of the display panel and provide a visual representation of the removal procedure.



**4x**  
M2x3



**Figure 57. Removing the display panel**

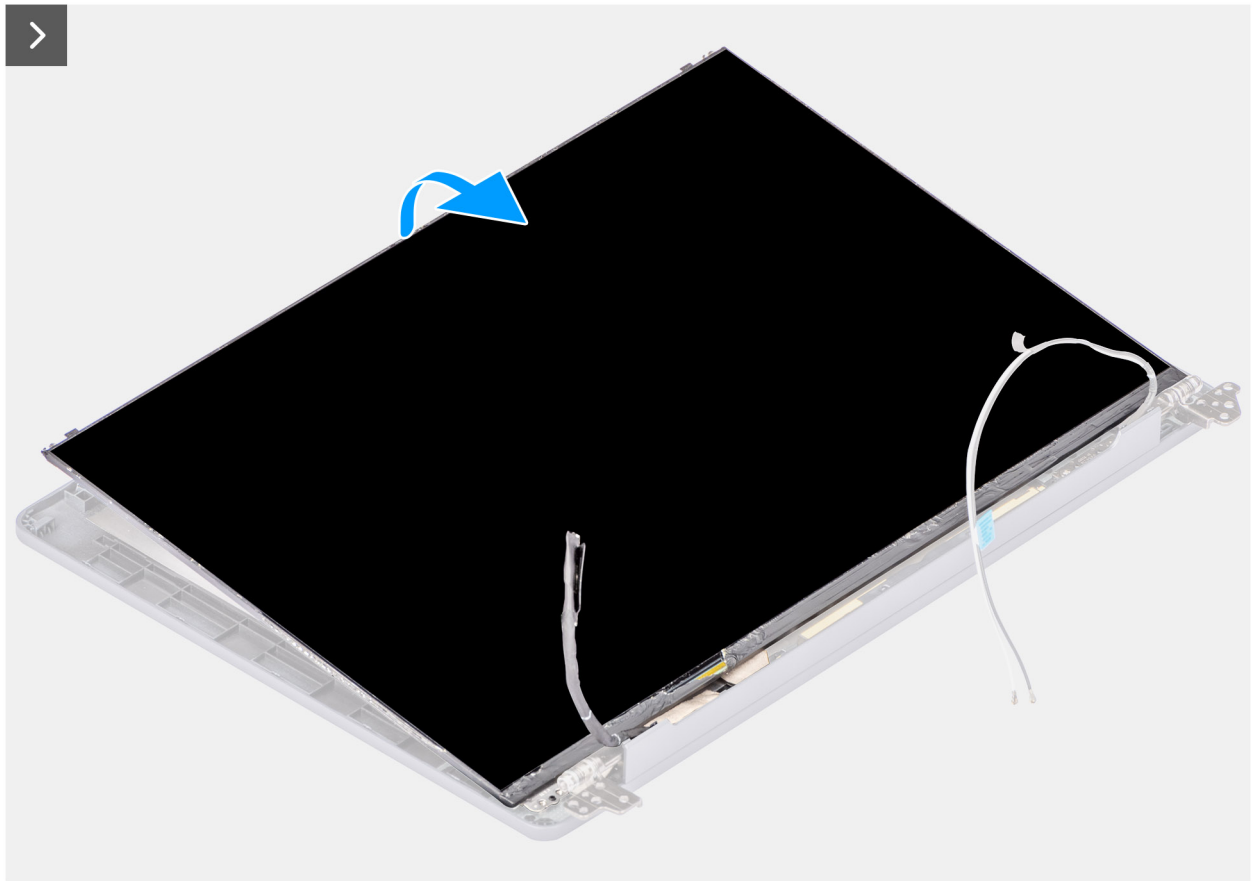


Figure 58. Removing the display panel

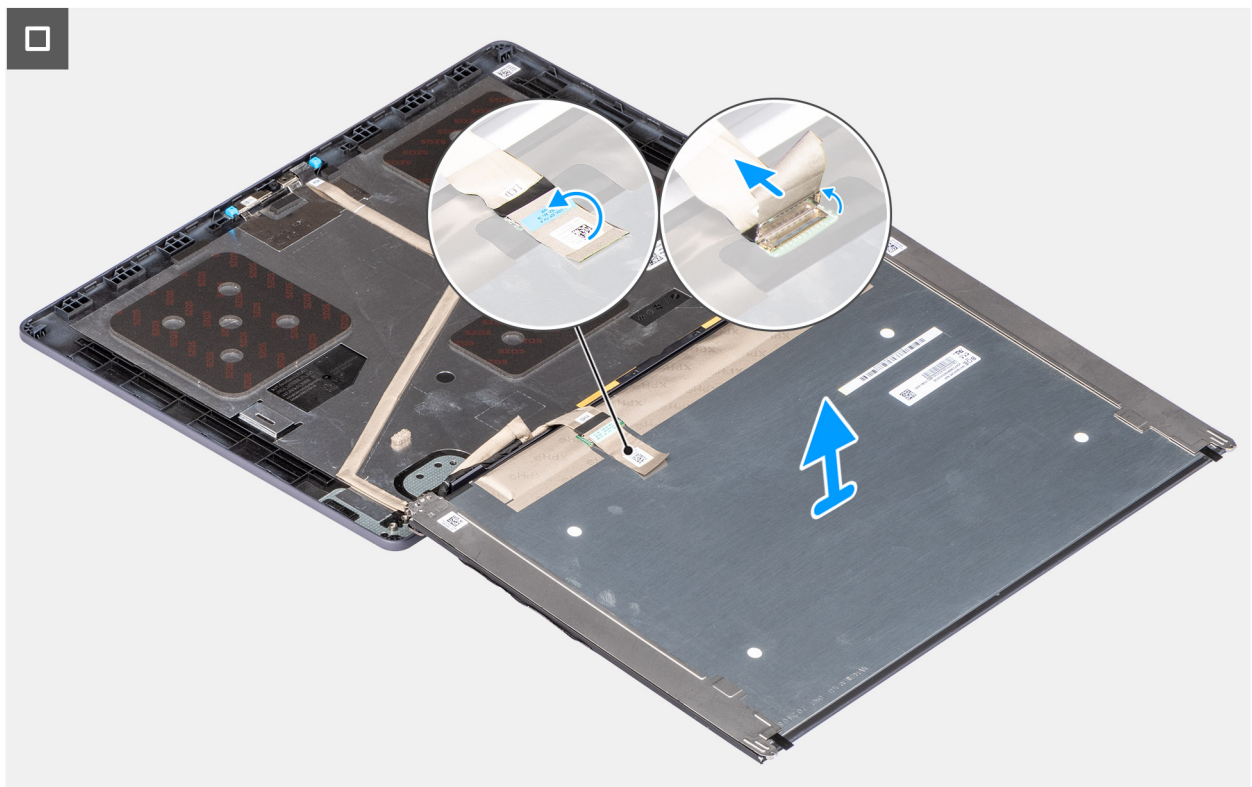


Figure 59. Removing the display panel

## Steps

1. Remove the four screws (M2x3) that secure the display-panel brackets to the display back-cover and antenna assembly.
2. Holding the display-panel brackets at the top, gently flip the display panel assembly forward. Then, peel back the tape that secures the display cable to the connector on the rear of the display panel.

**NOTE:** To prevent damage, ensure that the display panel has a clean and smooth surface to rest on.

3. Disconnect the display cable from the connector on the display panel and remove the display panel.

**CAUTION:** The display panel is assembled with the display-panel brackets as a single service part. Do not pull the two pieces of elastic tape and separate the brackets from the panel.



Figure 60. Display panel

## Installing the display panel

**CAUTION:** The information in this installation section is intended for authorized service technicians only.

### Prerequisites

If you are replacing a component, remove the existing component before performing the installation procedure.

### About this task

**NOTE:** The display panel is assembled with the display-panel brackets as a single service part.

The following images indicate the location of the display panel and provide a visual representation of the installation procedure.



4x  
M2x3

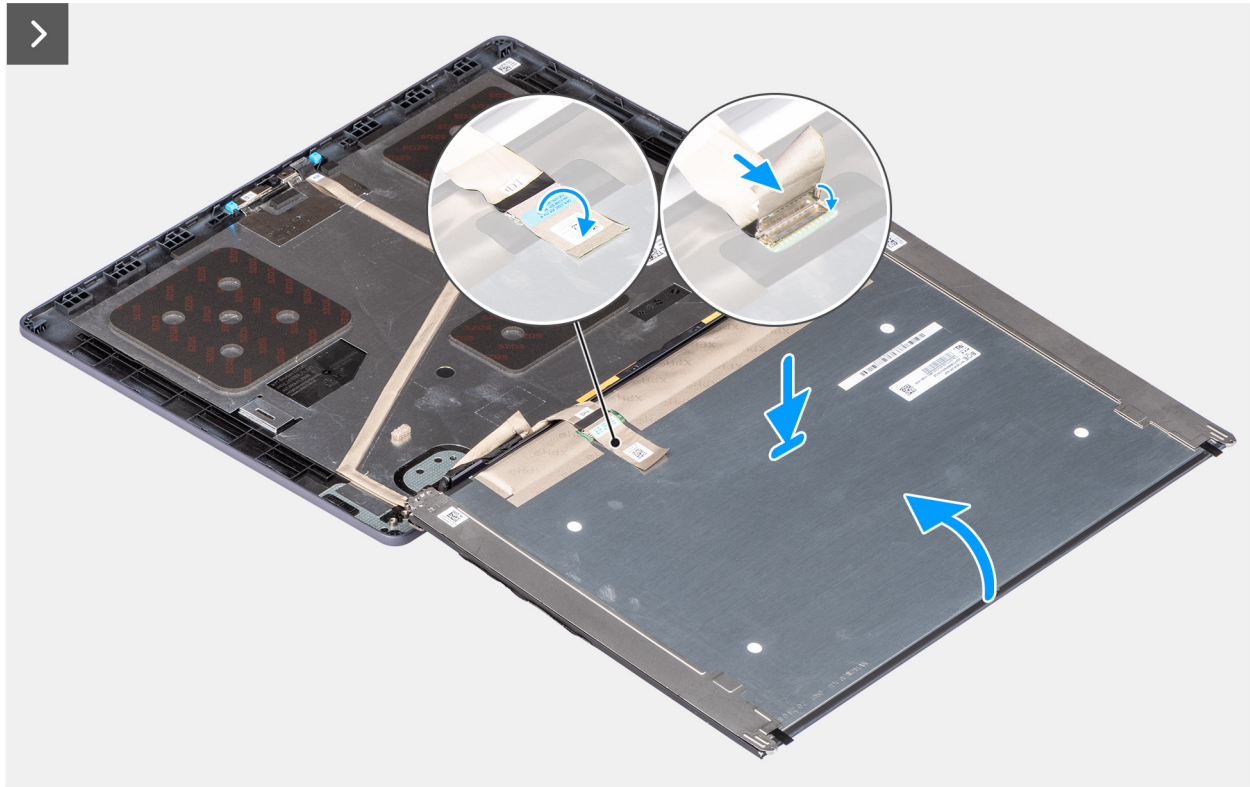
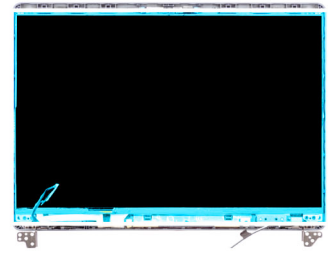


Figure 61. Installing the display panel



**Figure 62. Installing the display panel**

#### Steps

1. Place the display panel and display assembly on a clean and flat surface.
2. Connect the display cable to the connector on the display panel.
3. Adhere the tape to secure the display cable to the connector on the display panel.
4. Gently turn the display panel over and place the display panel in the slot on the display back cover.
5. Replace the four screws (M2x3) to secure the display-panel brackets to the display back-cover and antenna assembly.

#### Next steps

1. Install the [display bezel](#).
2. Install the [display assembly](#).
3. Install the [wireless card](#).
4. Install the [base cover](#).
5. Follow the procedure in [After working inside your computer](#).

## Display hinges

### Removing the display hinges

**CAUTION:** The information in this removal section is intended for authorized service technicians only.

#### Prerequisites

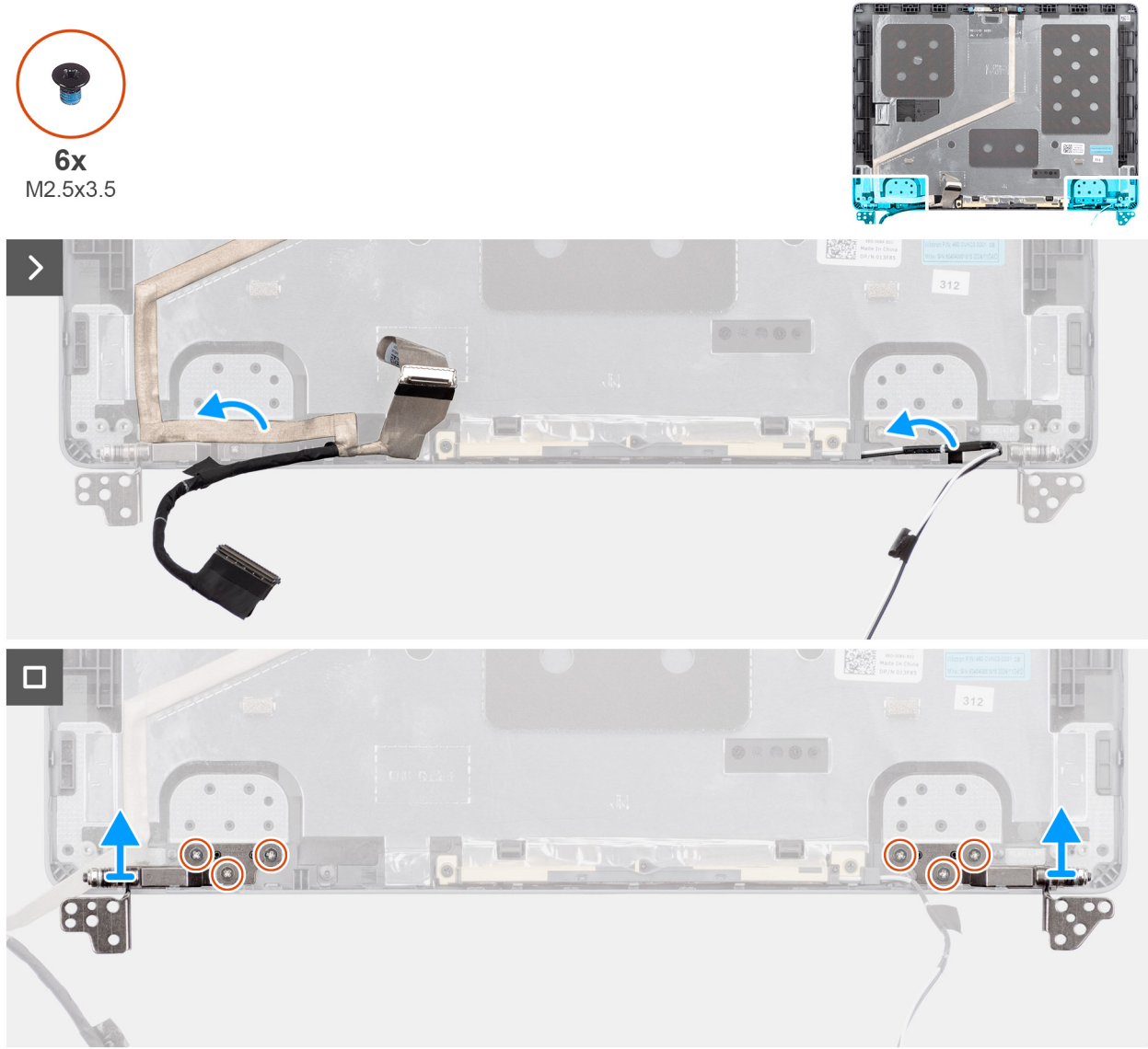
1. Follow the procedure in [Before working inside your computer](#).
2. Remove the [base cover](#).



3. Remove the [wireless card](#).
4. Remove the [display assembly](#).
5. Remove the [display bezel](#).
6. Remove the [display panel](#).

**About this task**

The following images indicate the location of the display hinges and provide a visual representation of the removal procedure.



**Figure 63. Removing the display hinges**

**Steps**

1. Gently peel back the display cable to access the left display hinge on the display back cover.
2. Gently peel back the tapes that secure the wireless-antenna cables to the display back cover.
3. Remove the three screws (M2.5x3.5) that secure the right display hinge to the display back cover.
4. Lift and remove the right display hinge from the display back-cover and antenna assembly.
5. Repeat steps 3 and 4 to remove the left display hinge from the display back-cover and antenna assembly.

# Installing the display hinges

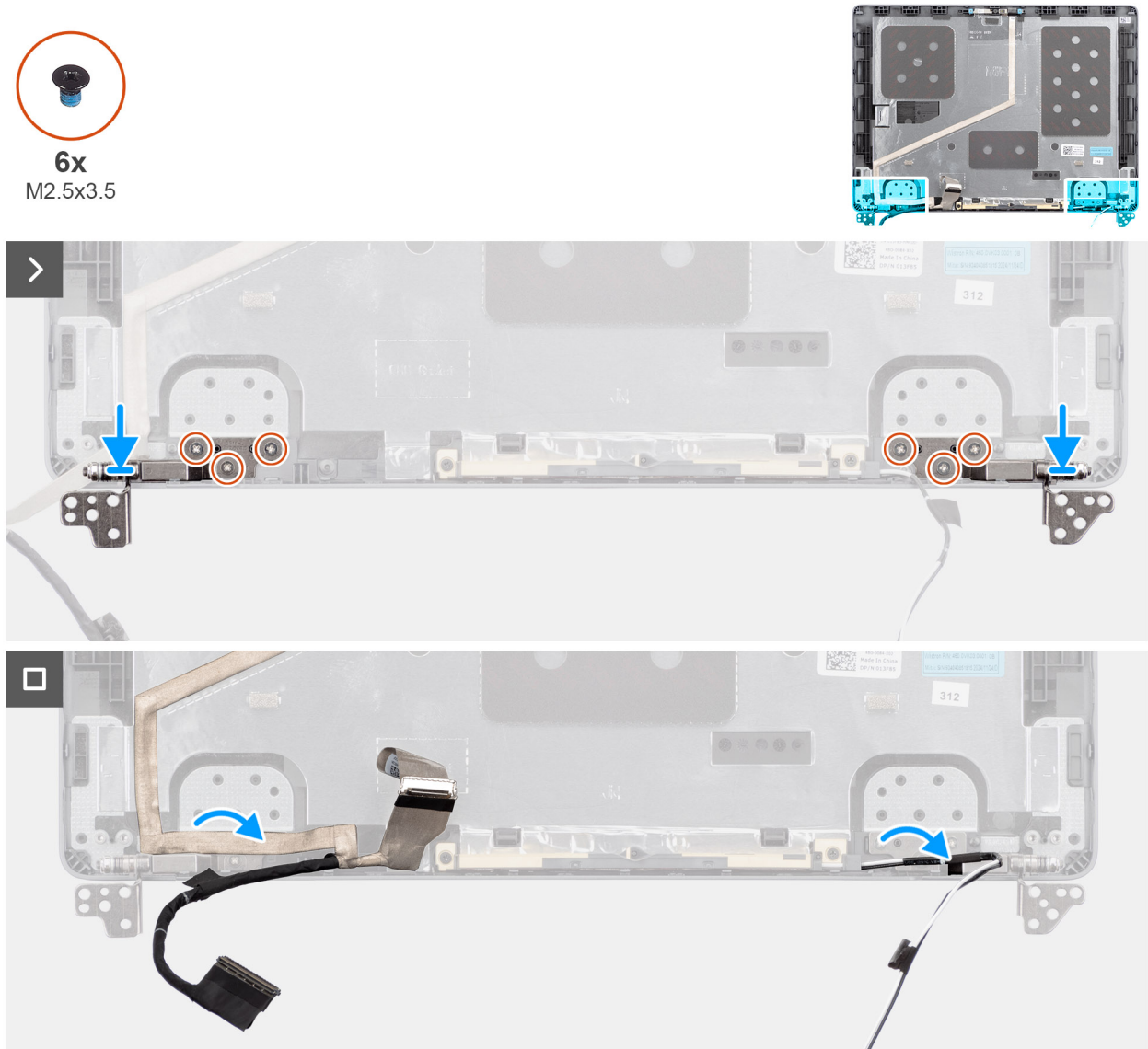
**CAUTION:** The information in this installation section is intended for authorized service technicians only.

## Prerequisites

If you are replacing a component, remove the existing component before performing the installation procedure.

## About this task

The following images indicate the location of the display hinges and provide a visual representation of the installation procedure.



**Figure 64. Installing the display hinges**

## Steps

1. Align and place the right display hinge on the display back-cover and antenna assembly.
2. Replace the three screws (M2.5x3.5) to secure the right display hinge to the display back cover.
3. Repeat steps 1 and 2 to secure the left display hinge to the display back cover.
4. Adhere the tapes to secure the wireless-antenna cables to the display back-cover and antenna assembly.
5. Adhere the display cable and secure it to the display back-cover and antenna assembly.



### Next steps

1. Install the [display panel](#).
2. Install the [display bezel](#).
3. Install the [display assembly](#).
4. Install the [wireless card](#).
5. Install the [base cover](#).
6. Follow the procedure in [After working inside your computer](#).

## Display cable

### Removing the display cable

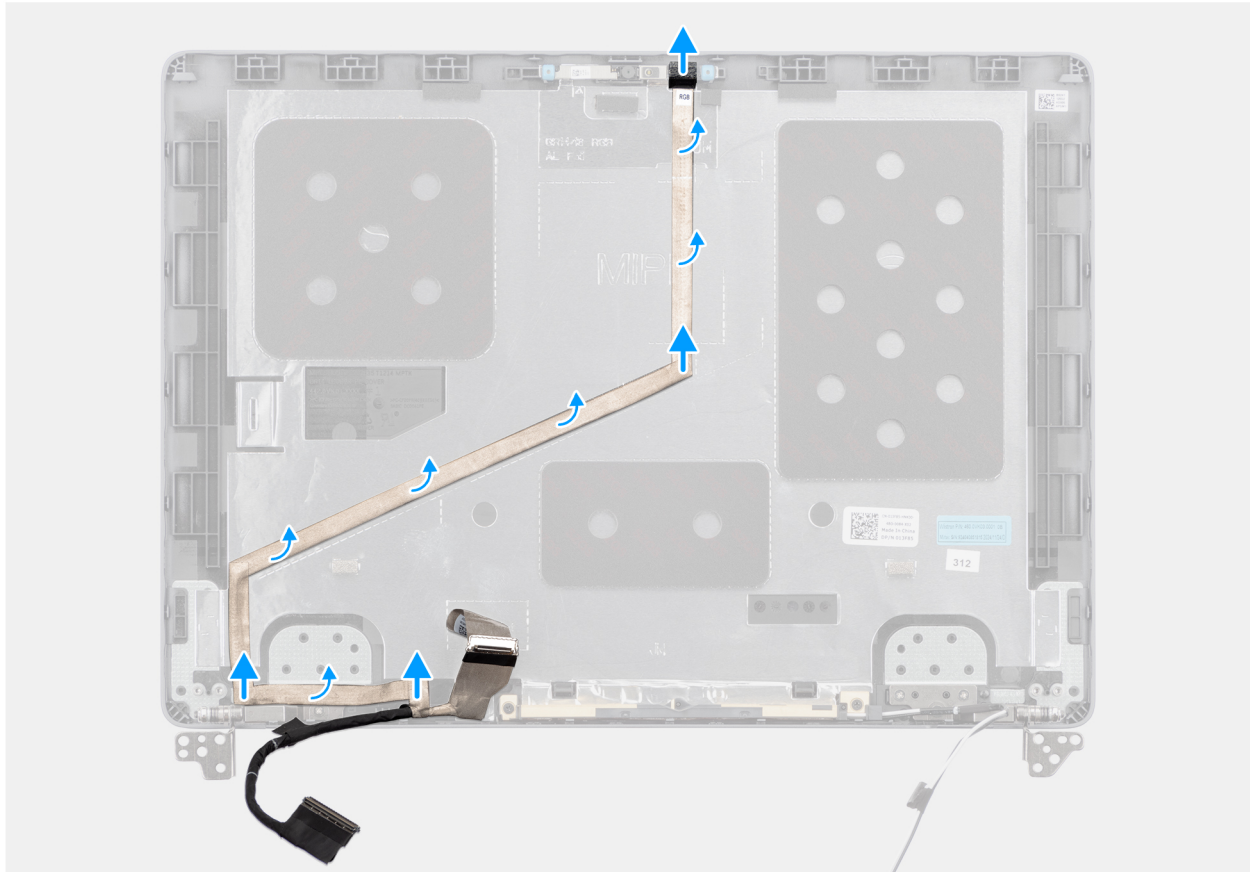
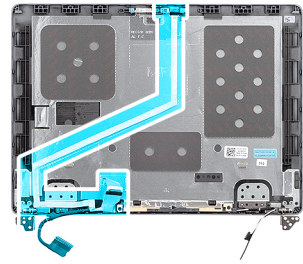
 **CAUTION:** The information in this removal section is intended for authorized service technicians only.

#### Prerequisites

1. Follow the procedure in [Before working inside your computer](#).
2. Remove the [base cover](#).
3. Remove the [wireless card](#).
4. Remove the [display assembly](#).
5. Remove the [display bezel](#).
6. Remove the [display panel](#).

#### About this task

The following image indicates the location of the display cable and provides a visual representation of the removal procedure.



**Figure 65. Removing the display cable**

**Steps**

1. Disconnect the display cable from the connector on the camera module.
2. Carefully peel back and remove the display cable from the display back-cover and antenna assembly.

## Installing the display cable

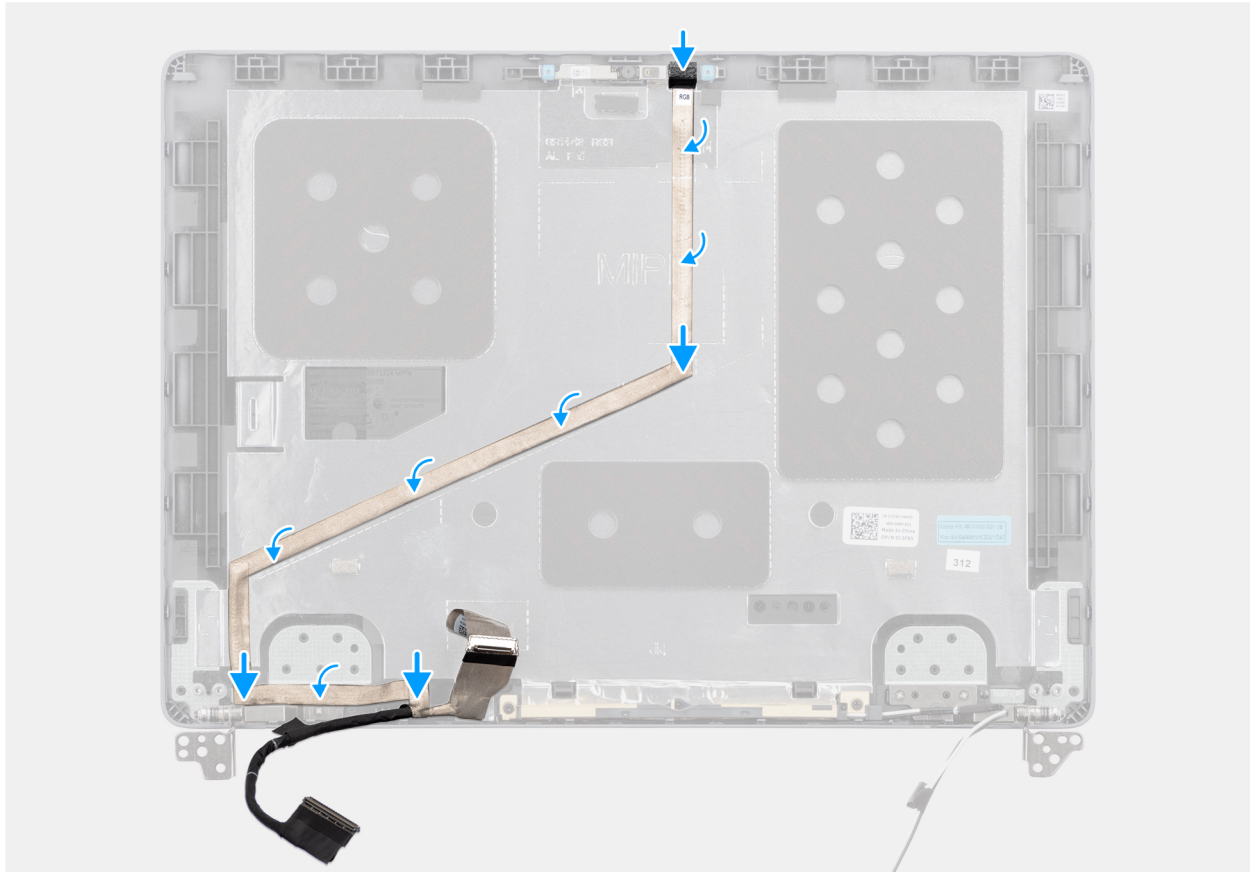
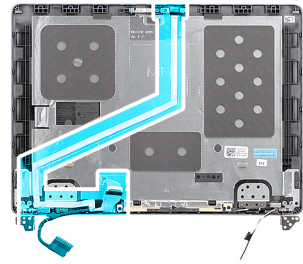
**CAUTION:** The information in this installation section is intended for authorized service technicians only.

**Prerequisites**

If you are replacing a component, remove the existing component before performing the installation procedure.

**About this task**

The following image indicates the location of the display cable and provides a visual representation of the installation procedure.



**Figure 66. Installing the display cable**

**Steps**

1. Adhere the display cable to the display back-cover and antenna assembly.
2. Connect the display cable to the connector on the camera module.

**Next steps**

1. Install the [display panel](#).
2. Install the [display bezel](#).
3. Install the [display assembly](#).
4. Install the [wireless card](#).
5. Install the [base cover](#).
6. Follow the procedure in [After working inside your computer](#).

# Camera

## Removing the camera

**CAUTION:** The information in this removal section is intended for authorized service technicians only.

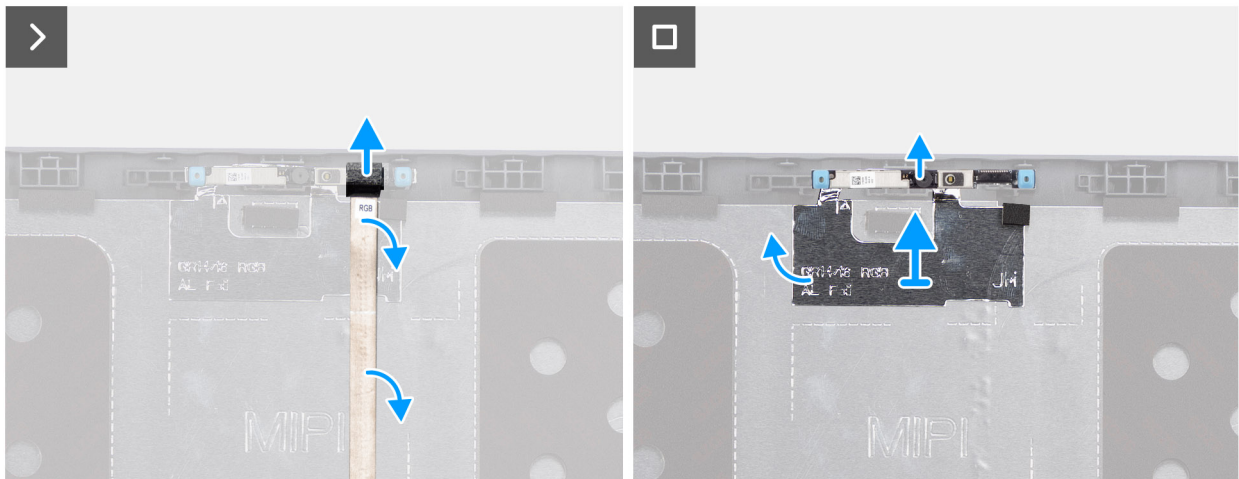
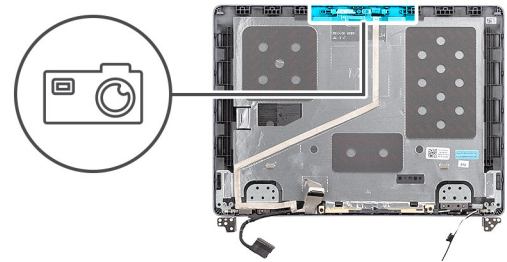
### Prerequisites

1. Follow the procedure in [Before working inside your computer](#).
2. Remove the [base cover](#).
3. Remove the [wireless card](#).
4. Remove the [display assembly](#).
5. Remove the [display bezel](#).
6. Remove the [display panel](#).

### About this task

**NOTE:** The camera module is removed with the foil as a single service part.

The following images indicate the location of the camera module and provide a visual representation of the removal procedure.



**Figure 67. Removing the camera**

### Steps

1. Disconnect the display cable from the connector on the camera module.
2. Gently peel back the copper or aluminum foil, whichever is applicable, from the display back-cover and antenna assembly.
3. Remove the camera module, along with the foil, from the display assembly.

## Installing the camera

**CAUTION:** The information in this installation section is intended for authorized service technicians only.

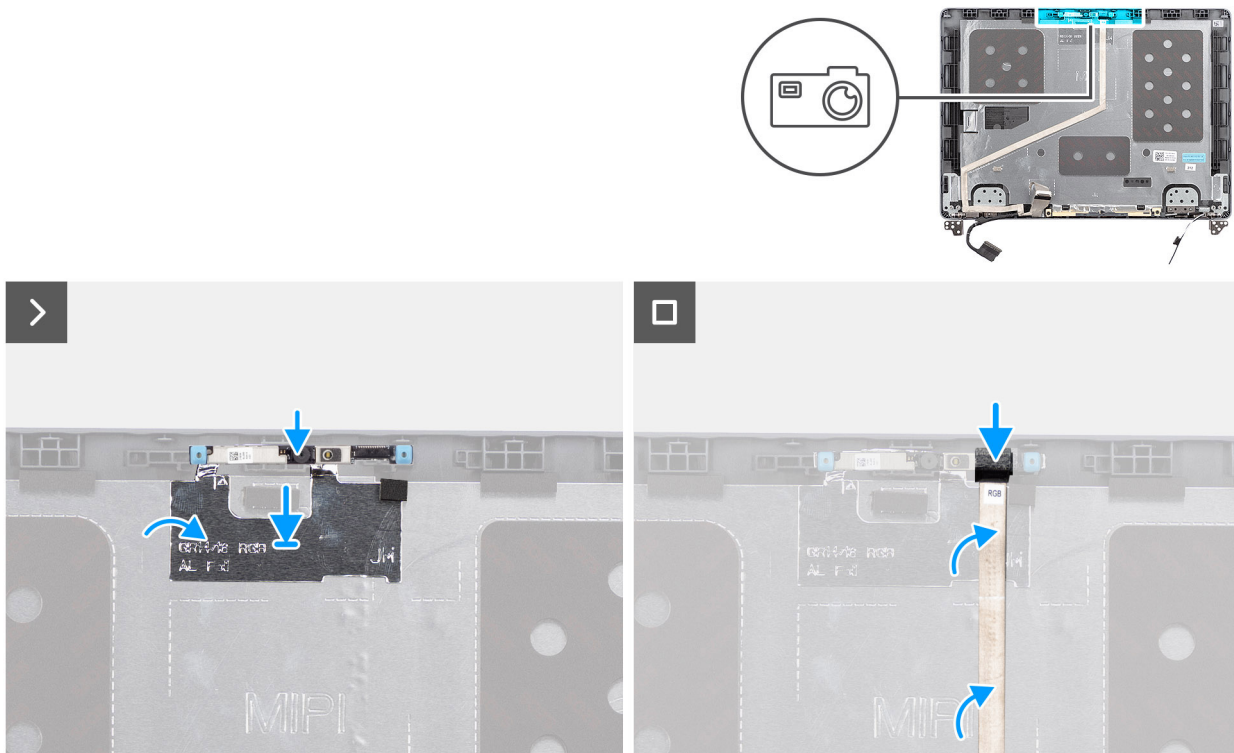
### Prerequisites

If you are replacing a component, remove the existing component before performing the installation procedure.

### About this task

**NOTE:** The camera module is installed with the foil as a single service part.

The following image indicates the location of the camera module and provides a visual representation of the installation procedure.



**Figure 68. Installing the camera**

### Steps

1. Align and place the camera module in the alignment post on the display back-cover and antenna assembly.
2. Adhere the copper or aluminum foil, whichever is applicable, to the display back-cover and antenna assembly.
3. Connect the display cable to the connector on the camera module.

### Next steps

1. Install the [display panel](#).
2. Install the [display bezel](#).
3. Install the [display assembly](#).
4. Install the [wireless card](#).
5. Install the [base cover](#).
6. Follow the procedure in [After working inside your computer](#).



# Display back-cover and antenna assembly

## Removing the display back-cover and antenna assembly

**CAUTION:** The information in this removal section is intended for authorized service technicians only.

### Prerequisites

1. Follow the procedure in [Before working inside your computer](#).
2. Remove the [base cover](#).
3. Remove the [wireless card](#).
4. Remove the [display assembly](#).
5. Remove the [display bezel](#).
6. Remove the [display panel](#).
7. Remove the [display hinges](#).
8. Remove the [display cable](#).
9. Remove the [camera](#).

### About this task

**NOTE:** The display back-cover and antenna assembly cannot be further disassembled once all the **Prerequisites** are completed. If the wireless antennas are malfunctioning and are required to be replaced, replace the entire display back-cover and antenna assembly.

The image below shows the display back-cover and antenna assembly after the **Prerequisites** have been performed.

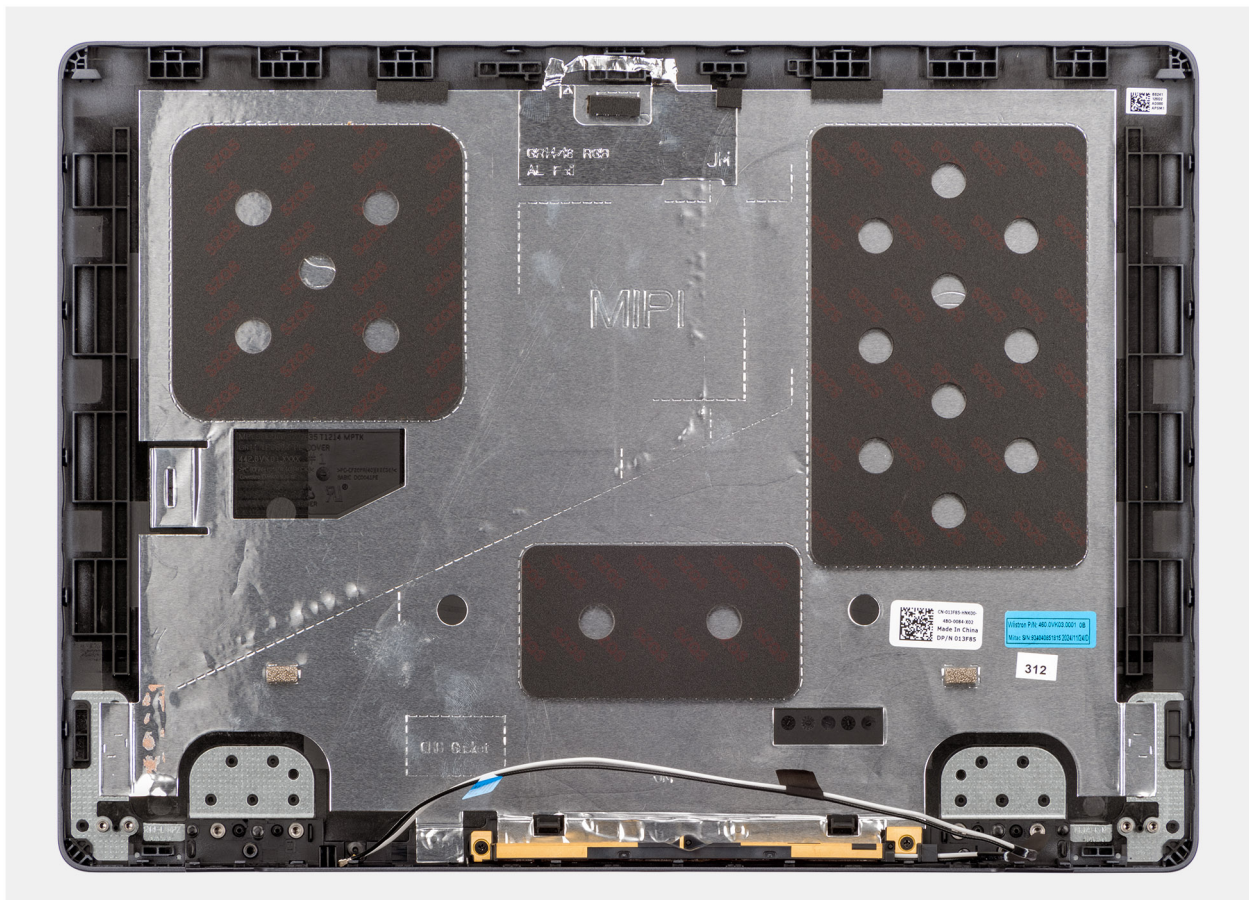


Figure 69. Display back-cover and antenna assembly



## Steps

After performing the **Prerequisites**, you are left with the display back-cover and antenna assembly.

## Installing the display back-cover and antenna assembly

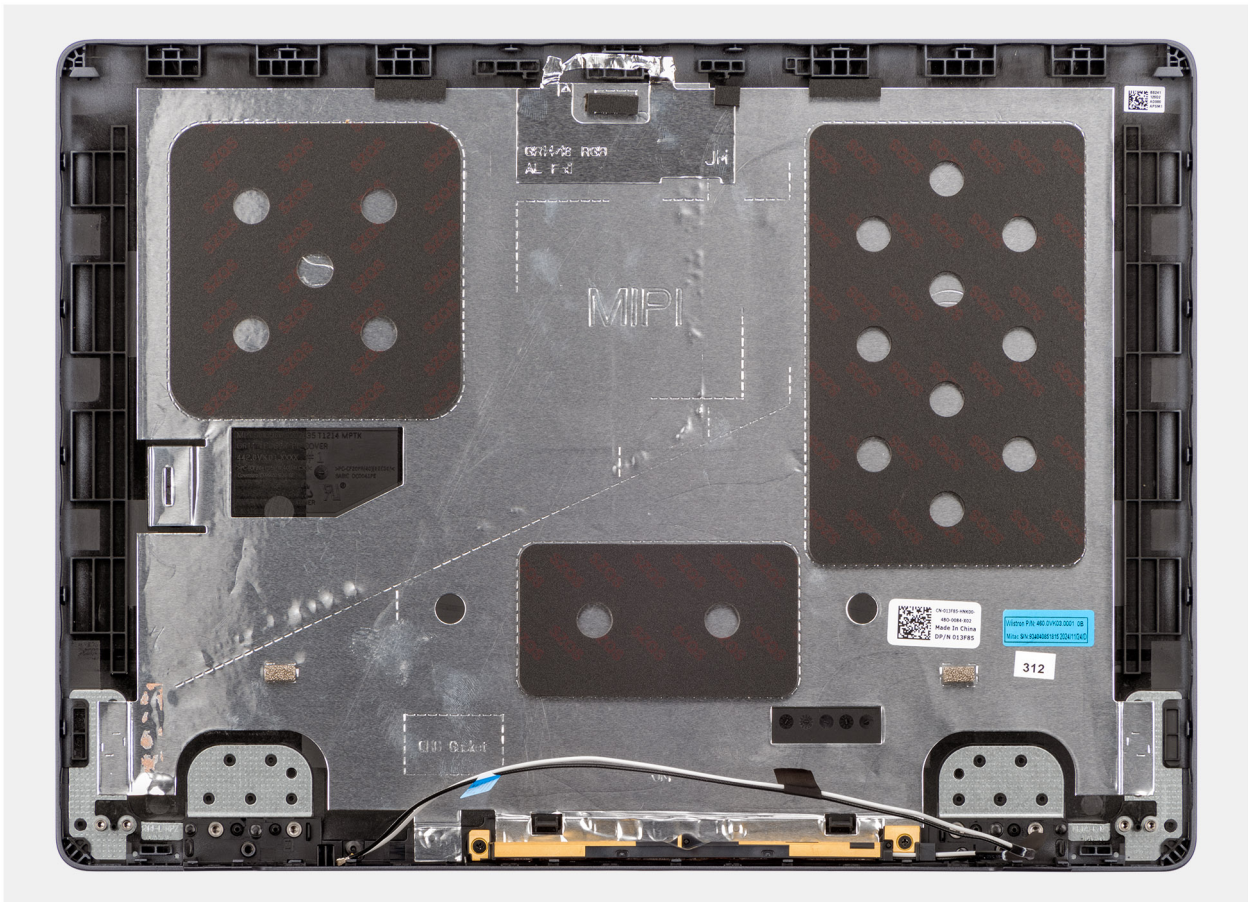
**CAUTION:** The information in this installation section is intended for authorized service technicians only.

### Prerequisites

If you are replacing a component, remove the existing component before performing the installation procedure.

### About this task

The image below shows the display back-cover and antenna assembly.



**Figure 70. Display back-cover and antenna assembly**

## Steps

Place the display back-cover and antenna assembly on a flat surface and perform the **Next steps** to install the display back-cover and antenna assembly.

### Next steps

1. Install the [camera](#).
2. Install the [display cable](#).
3. Install the [display hinges](#).
4. Install the [display panel](#).
5. Install the [display bezel](#).
6. Install the [display assembly](#).

7. Install the [wireless card](#).
8. Install the [base cover](#).
9. Follow the procedure in [After working inside your computer](#).

## System board

### Removing the system board

**CAUTION:** The information in this removal section is intended for authorized service technicians only.

#### Prerequisites

1. Follow the procedure in [Before working inside your computer](#).
2. Remove the [base cover](#).
3. Remove the [battery](#).
4. Remove the [memory module](#).
5. Remove the [M.2 2230 solid-state drive](#) or [M.2 2280 solid-state drive](#), whichever is applicable.
6. Remove the [wireless card](#).
7. Remove the [fan](#).
8. Remove the [battery frame](#).
9. Remove the [heat sink](#).

**NOTE:** If you are removing the system board to replace/access other parts, you may remove the system board with the heat sink attached to it in order to simplify the procedure and preserve the thermal bond between the system board and heat sink.

#### About this task

The following image indicates the connectors on your system board.

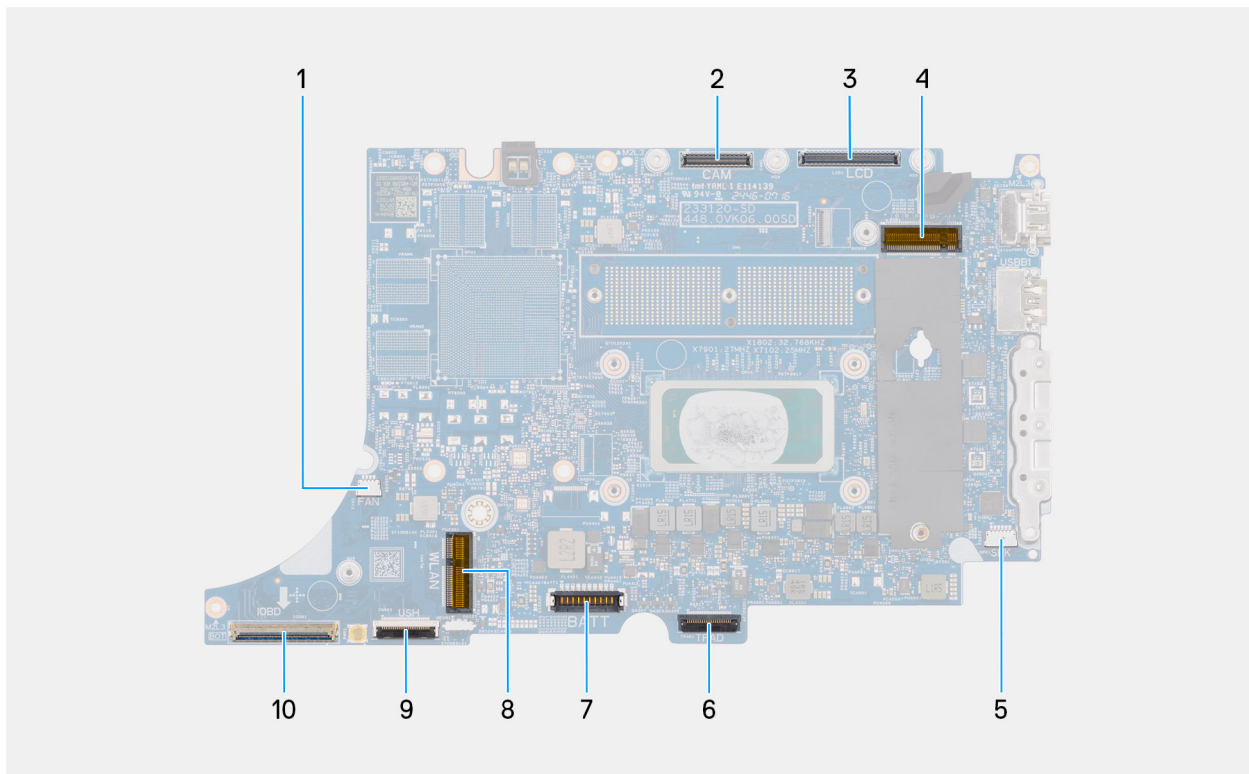
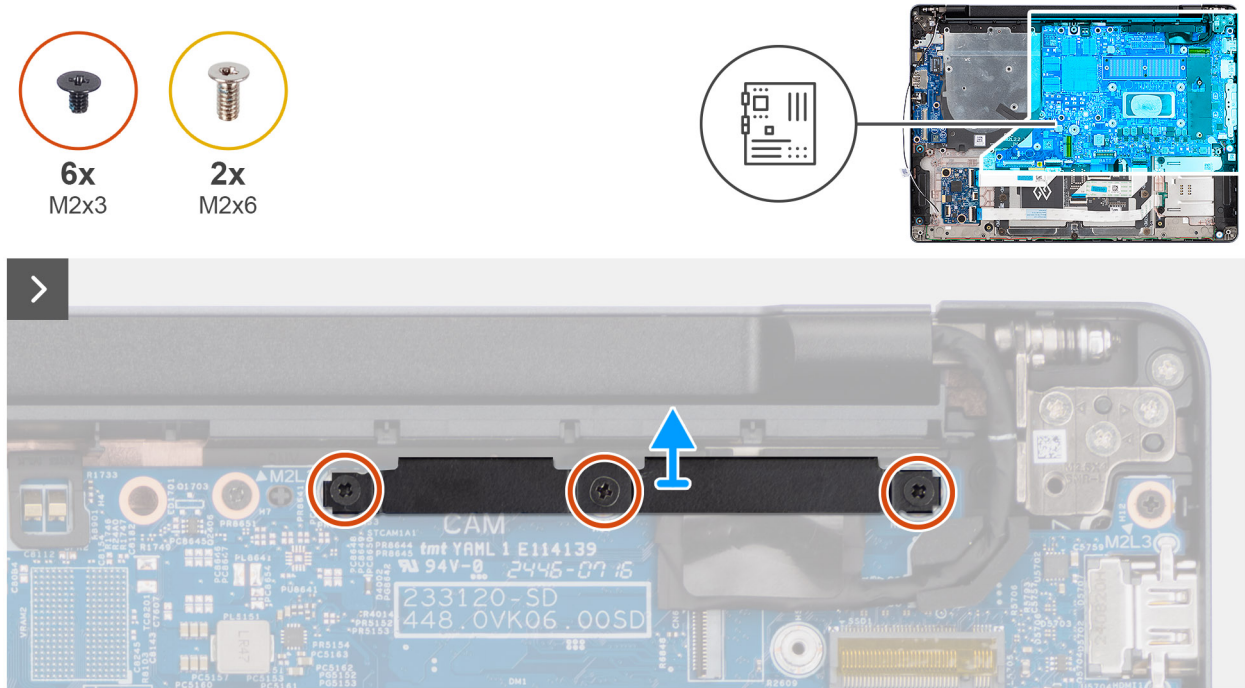


Figure 71. System board connectors

1. Fan-cable connector (FAN)
2. IR-camera cable connector (CAM)
3. Display-cable connector (LCD)
4. M.2 solid state drive connector (SSD)
5. Speaker-cable connector (SPK)
6. Touchpad-cable connector (TPAD)
7. Battery-cable connector (BATT)
8. Wireless-card connector (WLAN)
9. USH-board cable connector (USH)
10. I/O-board cable connector (IOBD)

The following images indicate the location of the system board and provide a visual representation of the removal procedure.



**Figure 72. Removing the system board**

**Steps**

1. Remove the three screws (M2x3) that secure the display-cable bracket to the system board.
2. Lift the display-cable bracket off the system board.
3. Carefully lift the memory-module connector from the system board and transfer it to the new replacement system board.



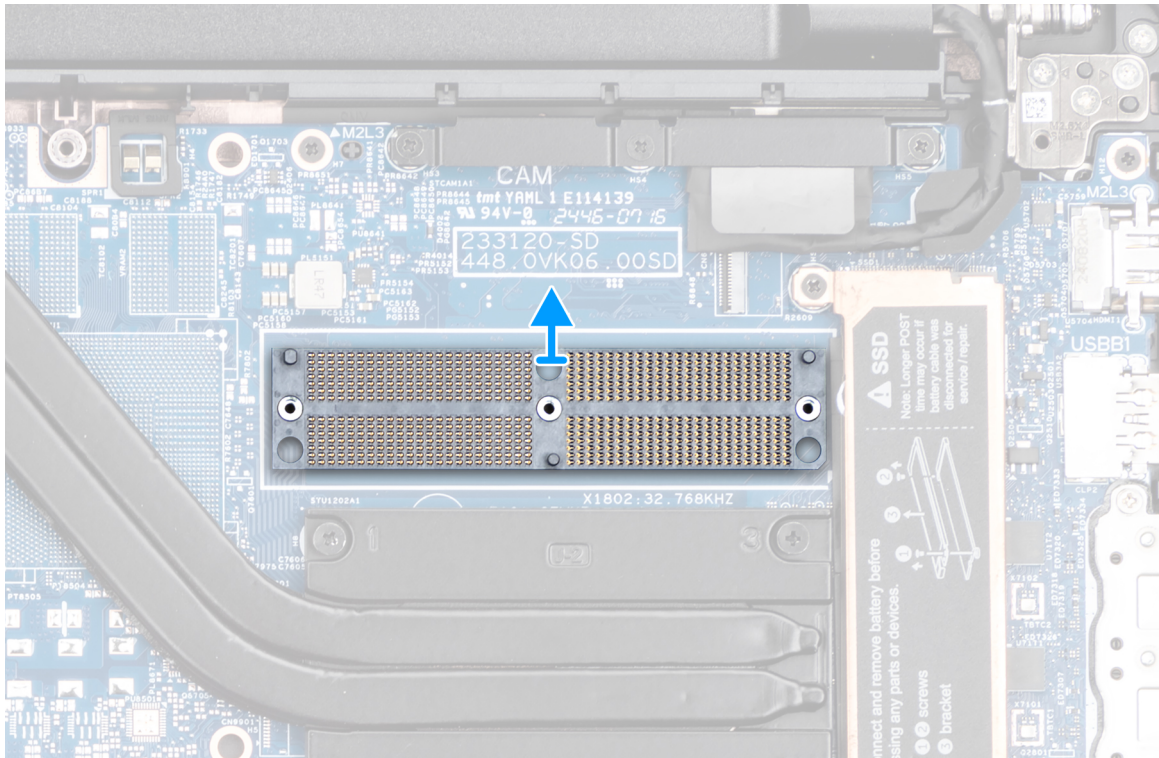


Figure 73. Removing the memory-module connector

**CAUTION:** When lifting the memory-module connector, do not touch the pins on the connector module. The pins are fragile and any direct contact with the pins may damage them. Only hold the connector from the edges to avoid contact with the pins.

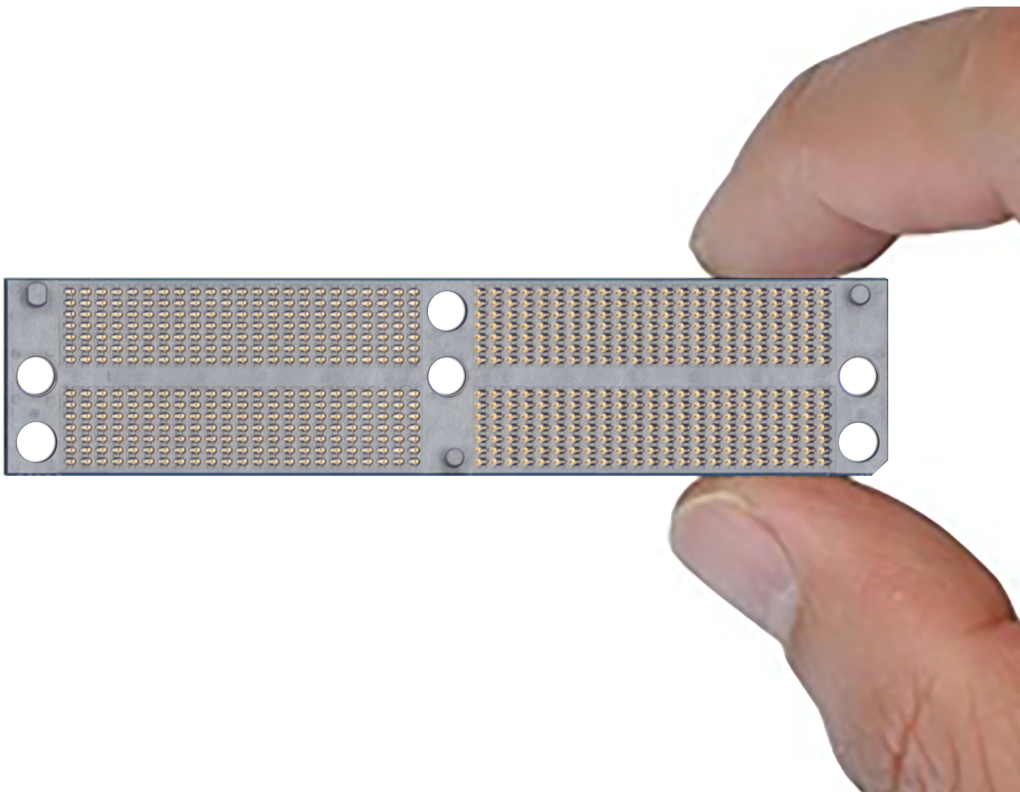
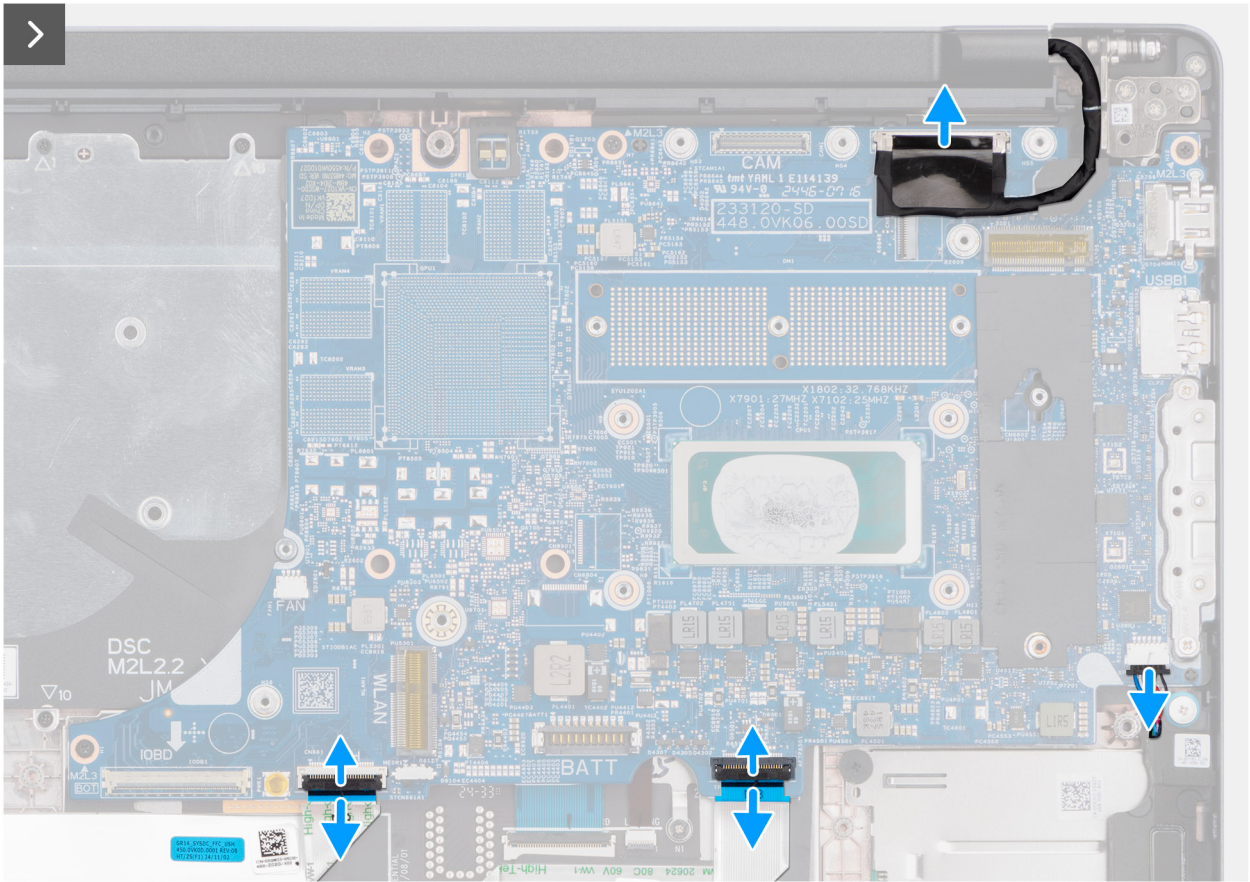


Figure 74. Removing the memory-module connector

4. Disconnect the following cables from the system board:
  - a. IR-camera cable (CAM)  
**i** **NOTE:** This step applies only to computers shipped with an IR camera installed.
  - b. Display cable (LCD)
  - c. Speaker cable (SPK)
  - d. Touchpad cable (TPAD)
  - e. USH-board cable (USH)



**Figure 75. Removing the system board**

5. Remove the three screws (M2x3) and the two screws (M2x6) that secure the system board to the palm-rest assembly.



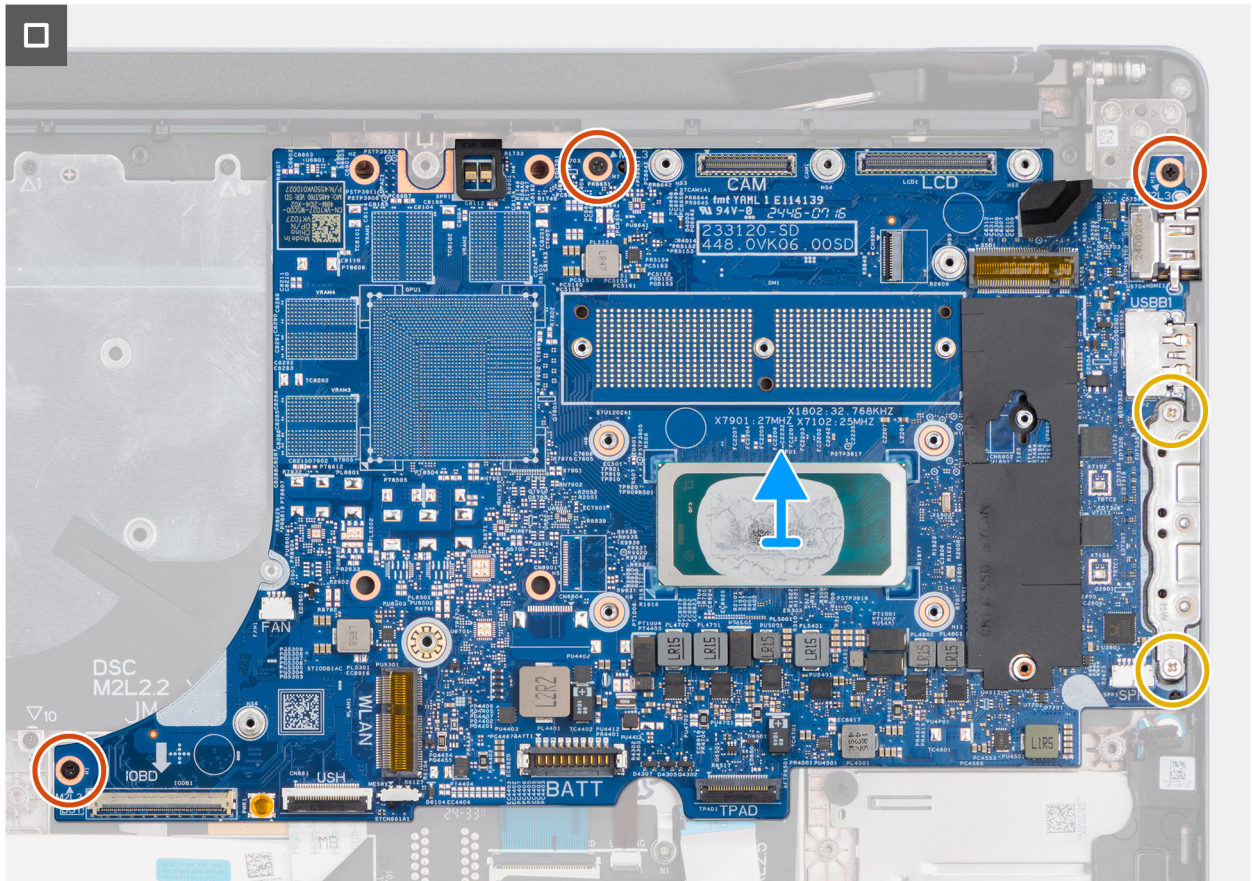


Figure 76. Removing the system board

6. Carefully lift and remove the system board at angle, from the palm-rest assembly, to clear the ports from the port slots.

## Installing the system board

**CAUTION:** The information in this installation section is intended for authorized service technicians only.

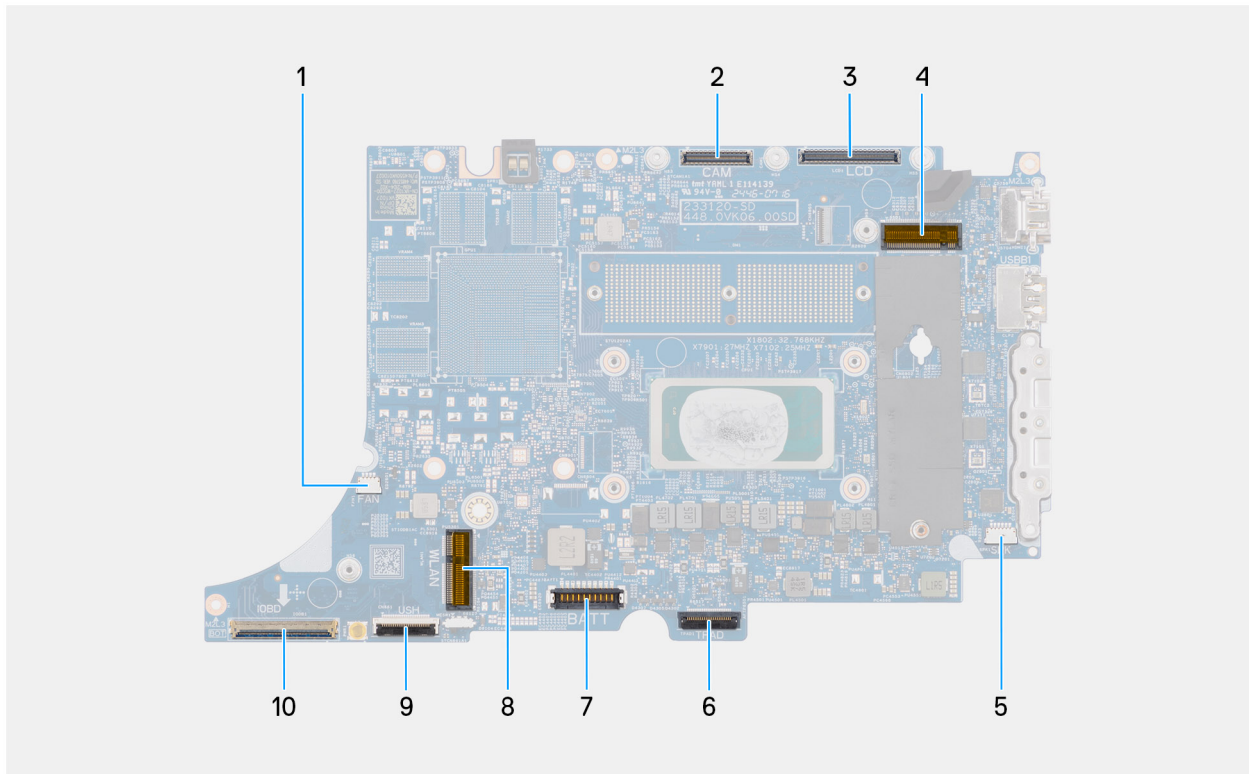
### Prerequisites

If you are replacing a component, remove the existing component before performing the installation procedure.

### About this task

The following image indicates the connectors on your system board.

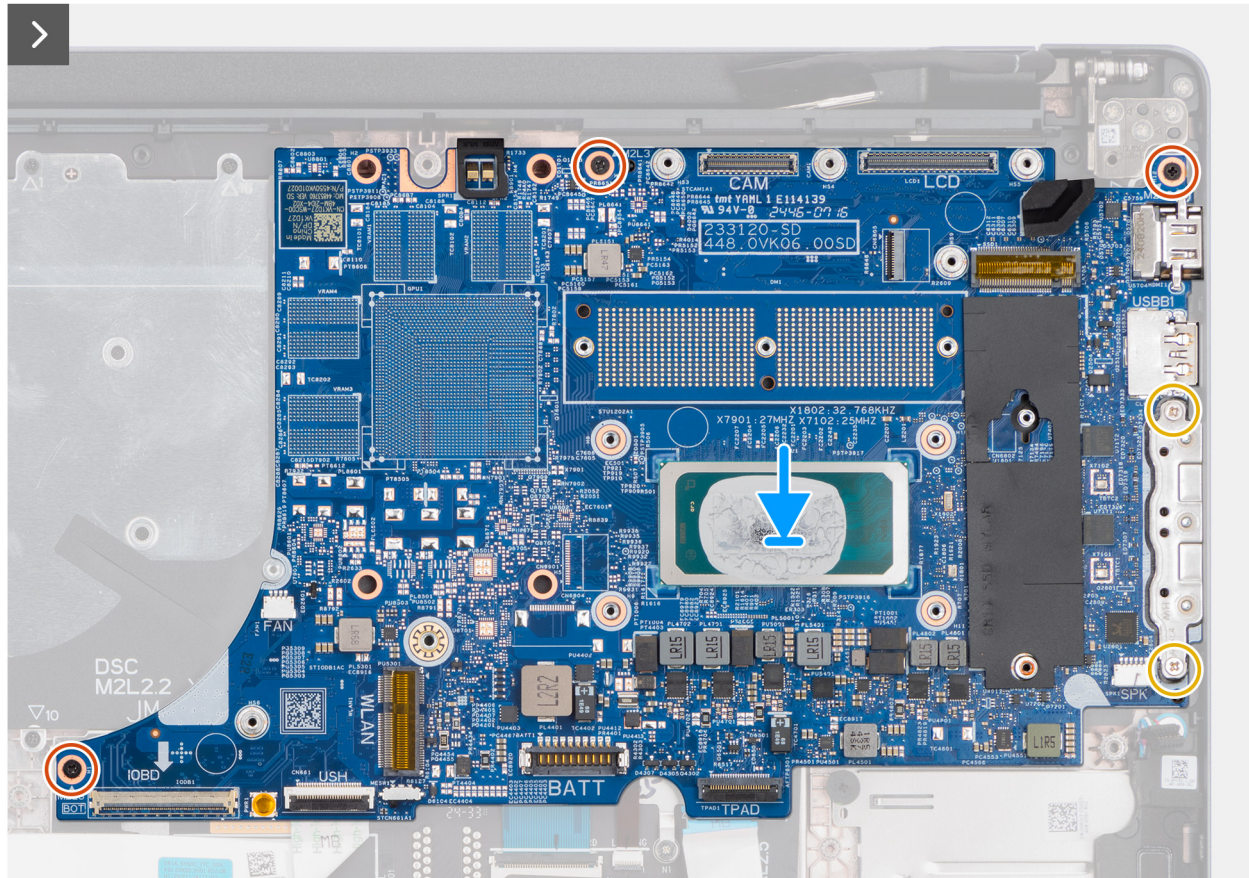




**Figure 77. System board connectors**

1. Fan-cable connector (FAN)
2. IR-camera cable connector (CAM)
3. Display-cable connector (LCD)
4. M.2 solid state drive connector (SSD)
5. Speaker-cable connector (SPK)
6. Touchpad-cable connector (TPAD)
7. Battery-cable connector (BATT)
8. Wireless-card connector (WLAN)
9. USH-board cable connector (USH)
10. I/O-board cable connector (IOBD)

The following images indicate the location of the system board and provide a visual representation of the installation procedure.



**Figure 78. Installing the system board**

**Steps**

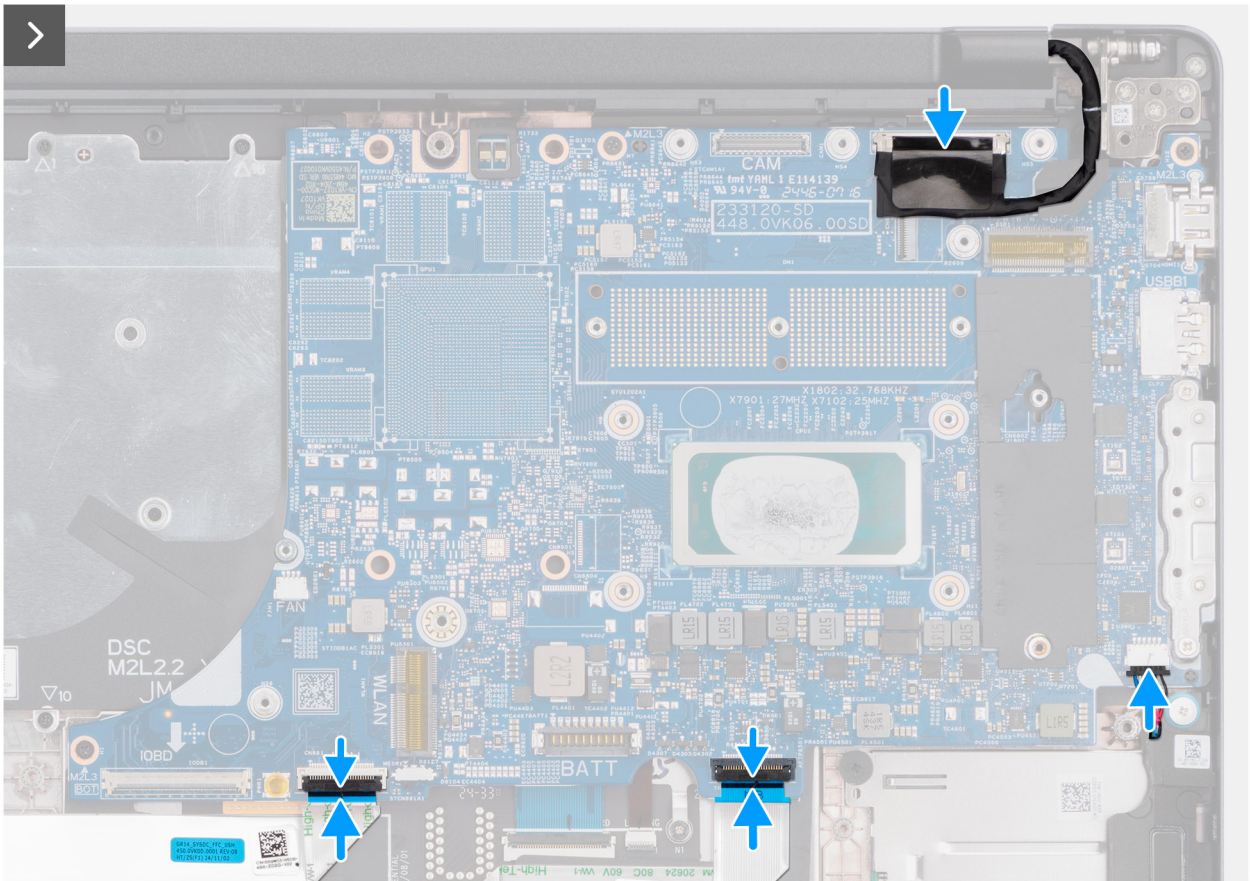
1. Align the ports on the system board to the port slots and place the system board on the palm-rest assembly.
2. Align the screw holes on the system board with the screw holes on the palm-rest assembly.
3. Replace the three screws (M2x3) and the two screws (M2x6) to secure the system board to the palm-rest assembly.
4. Connect the following cables to the system board:

- a. IR-camera cable (CAM)

**NOTE:** This step applies only to computers shipped with an IR camera installed.

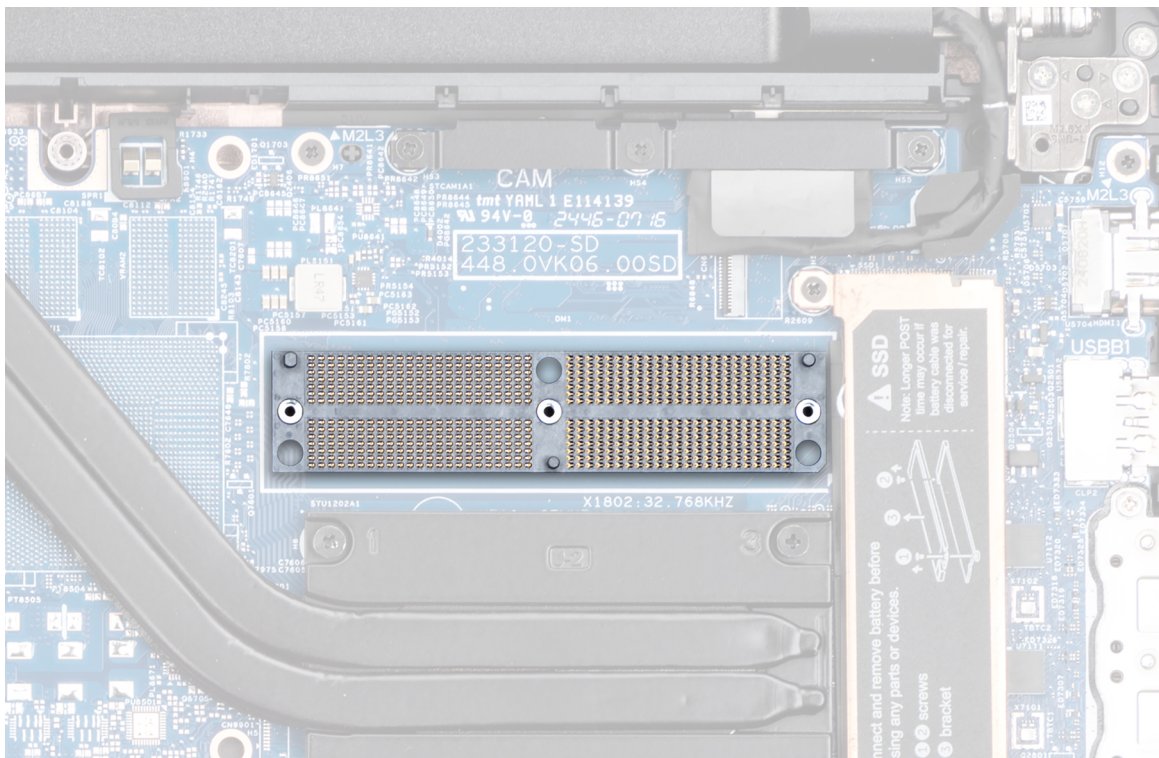
- b. Display cable (LCD)
- c. Speaker cable (SPK)
- d. Touchpad cable (TPAD)
- e. USH-board cable (USH)





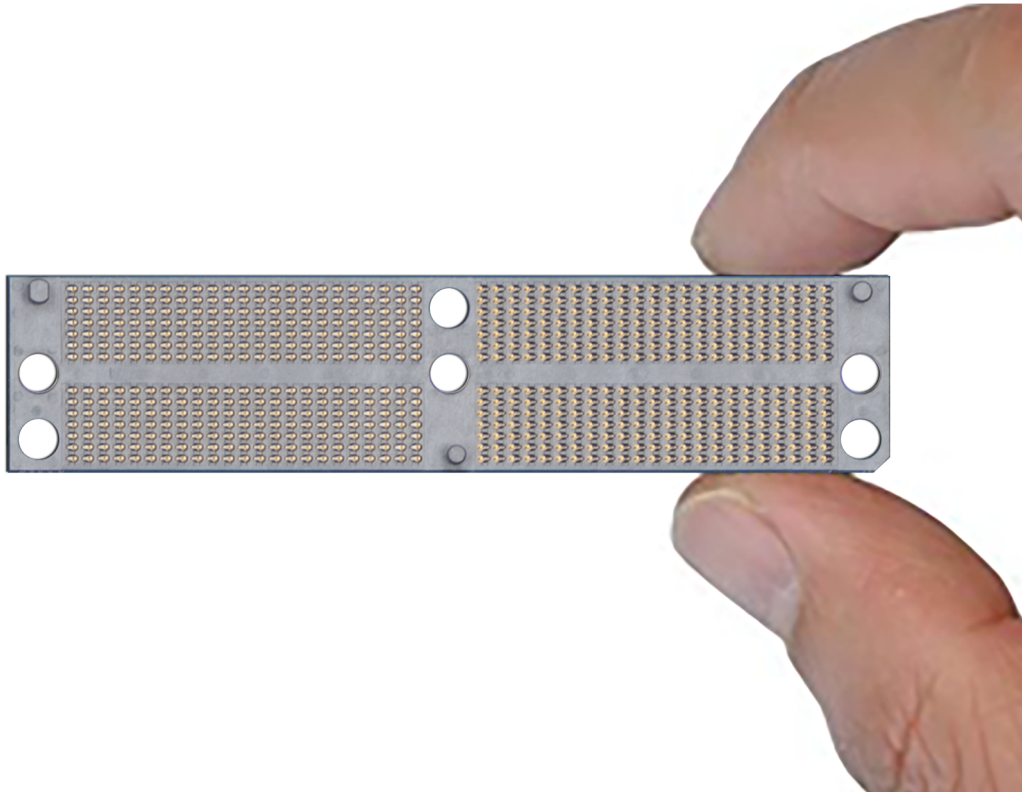
**Figure 79. Installing the system board**

- Carefully align and place the memory-module connector on the system board.



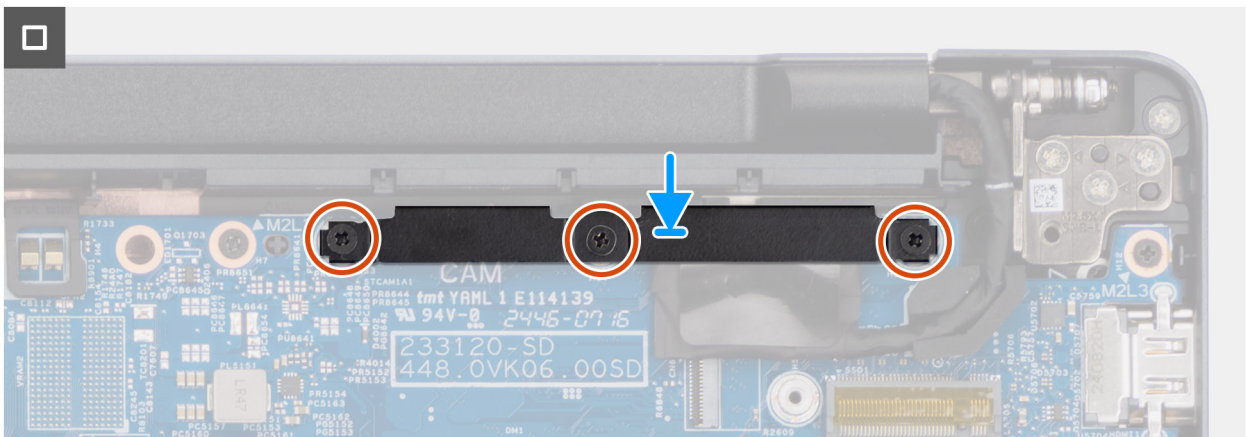
**Figure 80. Installing the memory-module connector**

**CAUTION:** When placing the memory-module connector, do not touch the pins on the connector module. The pins are fragile and any direct contact with the pins may damage them. Only hold the connector from the edges to avoid contact with the pins.



**Figure 81. Installing the memory-module connector**

6. Align and place the display-cable bracket over the display cable and IR-camera cable on the system board.
7. Replace the three screws (M2x3) to secure the display-cable bracket to the system board.



**Figure 82. Installing the system board**

### Next steps

1. Install the [heat sink](#).
2. Install the [battery frame](#).
3. Install the [fan](#).
4. Install the [wireless card](#).
5. Install the [M.2 2230 solid-state drive](#) or [M.2 2280 solid-state drive](#), whichever is applicable.

6. Install the [memory module](#).
7. Install the [battery](#).
8. Install the [base cover](#).
9. Follow the procedure in [After working inside your computer](#).


## USB Type-C module

### Removing the USB Type-C module

 **CAUTION:** The information in this removal section is intended for authorized service technicians only.

#### Prerequisites

1. Follow the procedure in [Before working inside your computer](#).
2. Remove the [base cover](#).
3. Remove the [battery](#).
4. Remove the [memory module](#).
5. Remove the [M.2 2230 solid-state drive](#) or [M.2 2280 solid-state drive](#), whichever is applicable.
6. Remove the [wireless card](#).
7. Remove the [fan](#).
8. Remove the [battery frame](#).
9. Remove the [heat sink](#).

 **NOTE:** If you are removing the system board to replace/access other parts, you may remove the system board with the heat sink attached to it in order to simplify the procedure and preserve the thermal bond between the system board and heat sink.

10. Remove the [system board](#).

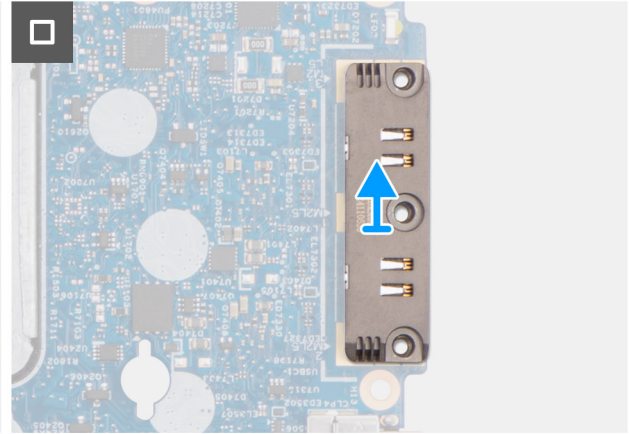
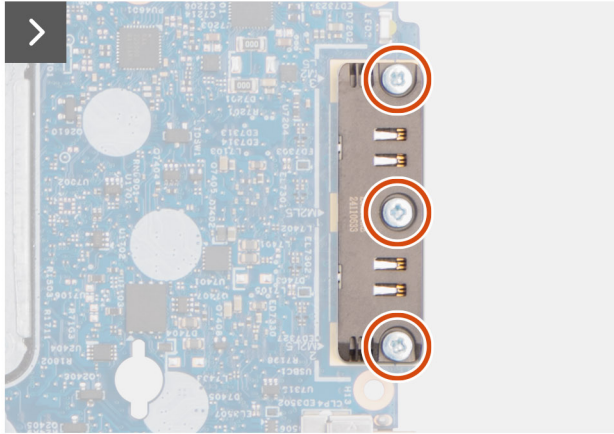
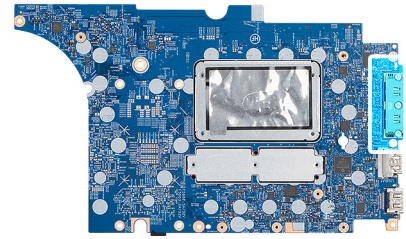
#### About this task

The following images indicate the location of the USB Type-C module and provide a visual representation of the removal procedure.





3x  
M2x5



**Figure 83. Removing the USB Type-C module**

#### Steps

1. Remove the three screws (M2x5) that secure the USB Type-C module to the system board.
2. Lift the USB Type-C module off the system board.

## Installing the USB Type-C module

**CAUTION:** The information in this installation section is intended for authorized service technicians only.

#### Prerequisites

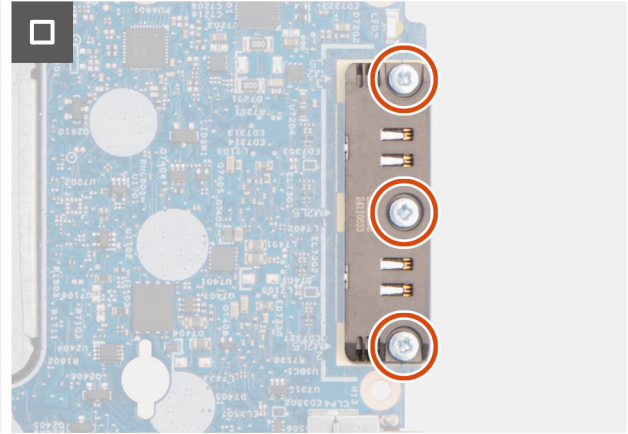
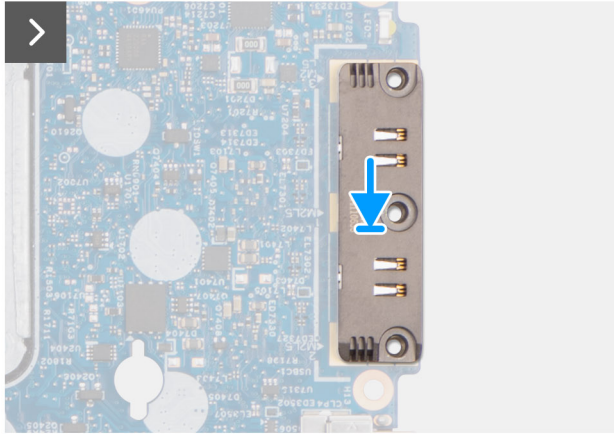
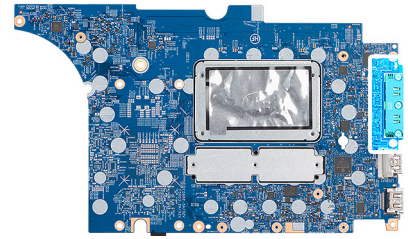
If you are replacing a component, remove the existing component before performing the installation procedure.

#### About this task

The following images indicate the location of the USB Type-C module and provide a visual representation of the installation procedure.



3x  
M2x5



**Figure 84. Installing the USB Type-C module**

#### Steps

1. Align and place the USB Type-C module over the USB Type-C ports on the system board.
2. Replace the three screws (M2x5) to secure the USB Type-C module to the system board.

#### Next steps

1. Install the [system board](#).
2. Install the [heat sink](#).
3. Install the [battery frame](#).
4. Install the [fan](#).
5. Install the [wireless card](#).
6. Install the [M.2 2230 solid-state drive](#) or [M.2 2280 solid-state drive](#), whichever is applicable.
7. Install the [memory module](#).
8. Install the [battery](#).
9. Install the [base cover](#).
10. Follow the procedure in [After working inside your computer](#).

## Keyboard

### Removing the keyboard

**⚠ CAUTION:** The information in this removal section is intended for authorized service technicians only.

#### Prerequisites

1. Follow the procedure in [Before working inside your computer](#).
2. Remove the [base cover](#).
3. Remove the [battery](#).
4. Remove the [memory module](#).
5. Remove the [M.2 2230 solid-state drive](#) or [M.2 2280 solid-state drive](#), whichever is applicable.

6. Remove the [wireless card](#).
7. Remove the [fan](#).
8. Remove the [battery frame](#).
9. Remove the [heat sink](#).

**NOTE:** If you are removing the system board to replace/access other parts, you may remove the system board with the heat sink attached to it in order to simplify the procedure and preserve the thermal bond between the system board and heat sink.

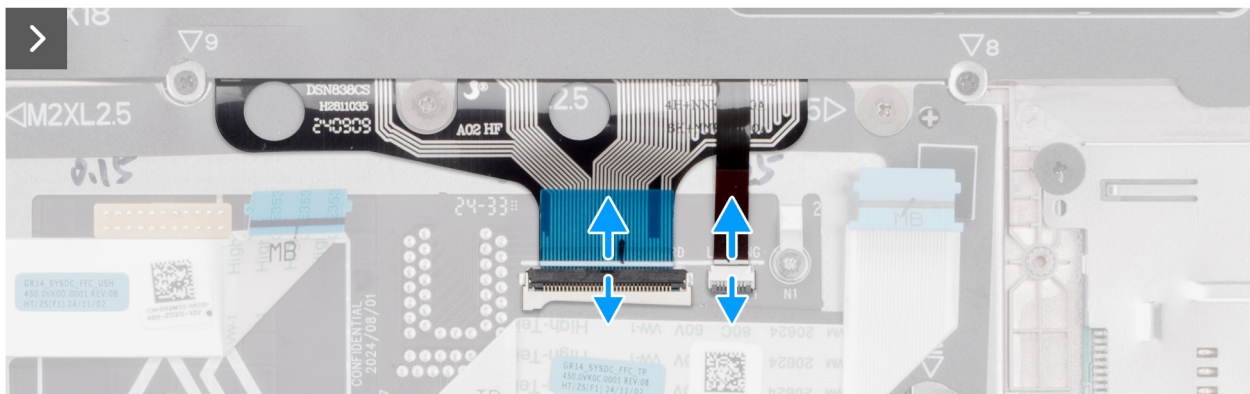
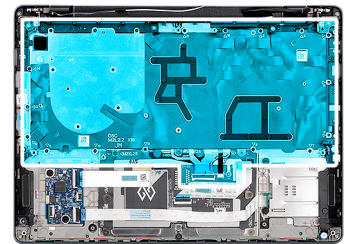
10. Remove the [I/O board](#).
11. Remove the [power button](#).
12. Remove the [system board](#).

### About this task

The following images indicate the location of the keyboard and provide a visual representation of the removal procedure.



**21x**  
M2x2.2



**Figure 85. Removing the keyboard**



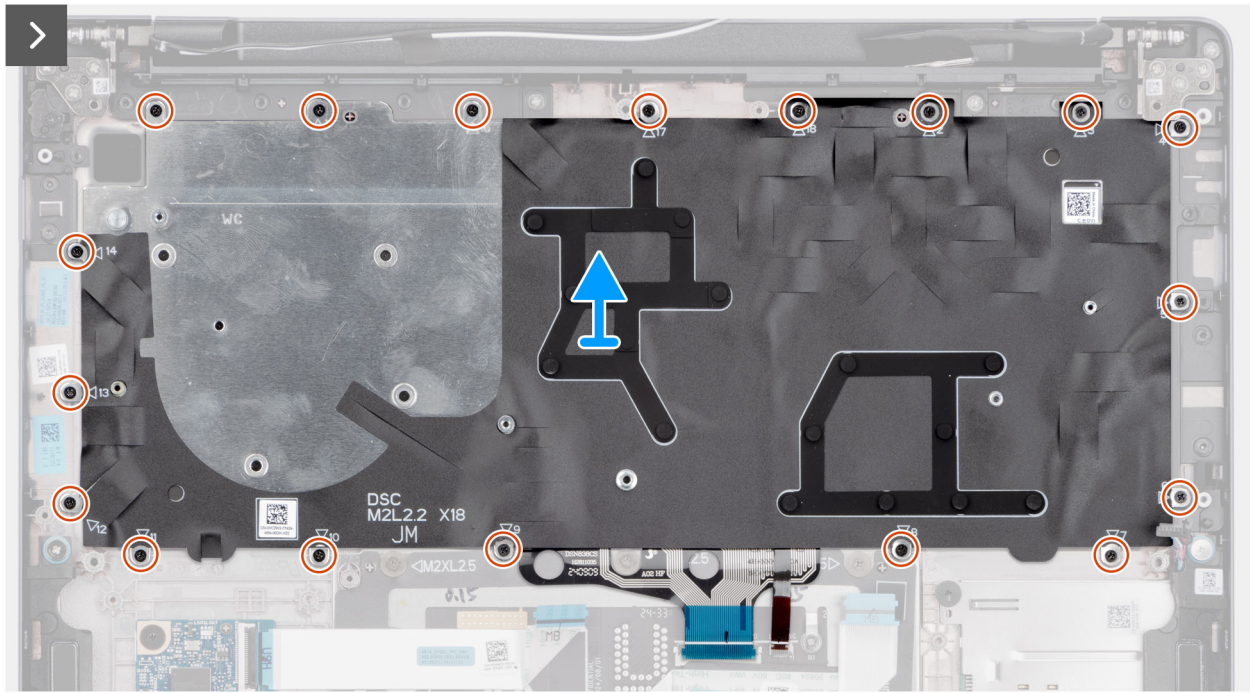


Figure 86. Removing the keyboard



Figure 87. Removing the keyboard

### Steps

1. Disconnect the keyboard cable from the connector (KEYBOARD) on the touchpad board.
2. Disconnect the keyboard-backlight cable from the connector (LIGHTING) on the touchpad board.
  - ⓘ **NOTE:** This step applies only to computers shipped with a backlit keyboard installed.
3. Remove the 18 screws (M2x2.2) that secure the keyboard assembly to the palm-rest assembly.
4. Lift the keyboard assembly off the palm-rest assembly.
5. Remove the three screws (M2x2.2) that secure the keyboard to the keyboard bracket.

6. Lift the keyboard off the keyboard bracket.

## Installing the keyboard

**CAUTION:** The information in this installation section is intended for authorized service technicians only.

### Prerequisites

If you are replacing a component, remove the existing component before performing the installation procedure.

### About this task

The following images indicate the location of the keyboard and provide a visual representation of the installation procedure.



Figure 88. Installing the keyboard



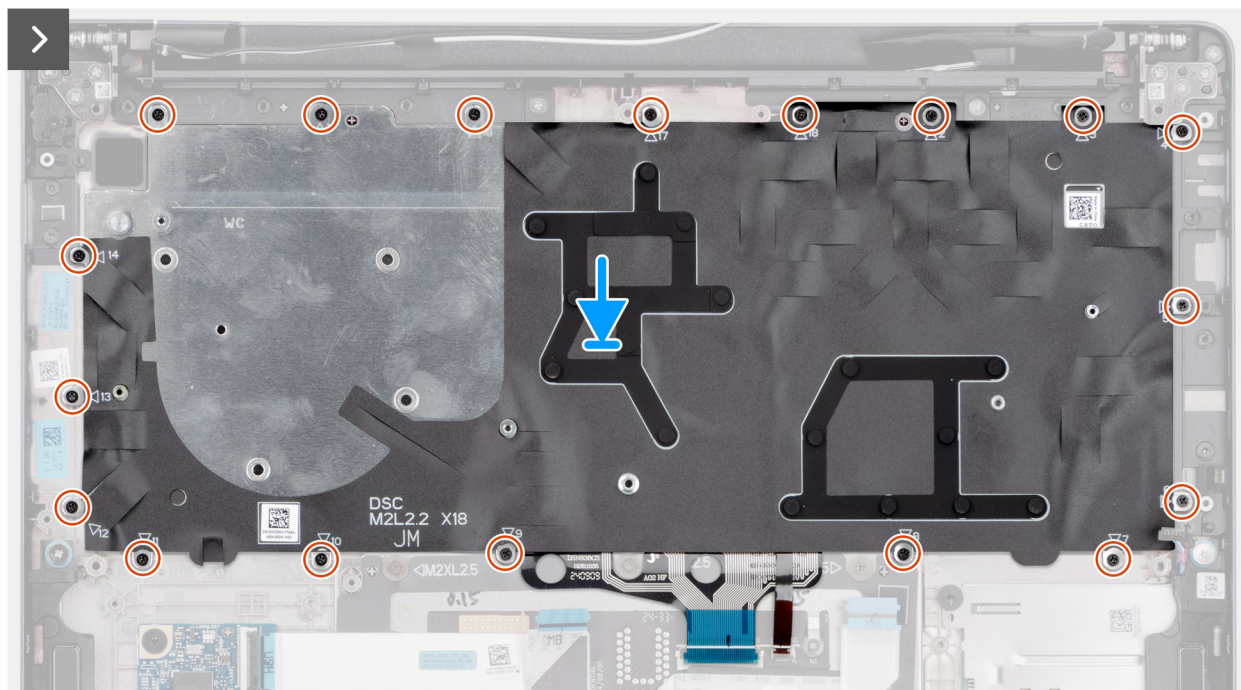


Figure 89. Installing the keyboard

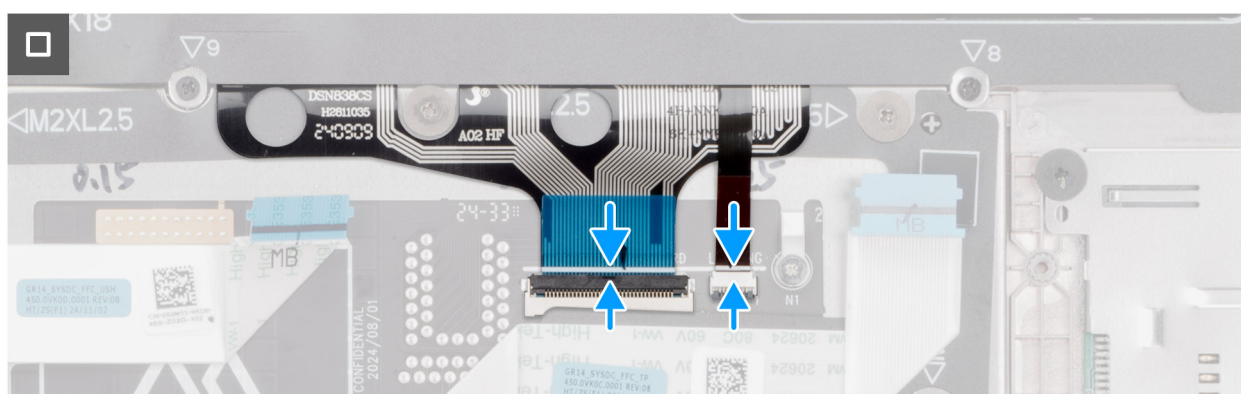


Figure 90. Installing the keyboard

### Steps

1. Align and place the keyboard over the keyboard bracket.
2. Replace the three screws (M2x2.2) to secure the keyboard to the keyboard bracket.
3. Align and place the keyboard assembly in the slot on the palm-rest assembly.
4. Replace the 18 screws (M2x2.2) to secure the keyboard assembly to the palm-rest assembly.
5. Connect the keyboard cable to the connector (KEYBOARD) on the touchpad board.
6. Connect the keyboard-backlight cable to the connector (LIGHTING) on the touchpad board.

**NOTE:** This step applies only to computers shipped with a backlit keyboard installed.

### Next steps

1. Install the [system board](#).
2. Install the [power button](#).
3. Install the [I/O board](#).
4. Install the [heat sink](#).
5. Install the [battery frame](#).

6. Install the [fan](#).
7. Install the [wireless card](#).
8. Install the [M.2 2230 solid-state drive](#) or [M.2 2280 solid-state drive](#), whichever is applicable.
9. Install the [memory module](#).
10. Install the [battery](#).
11. Install the [base cover](#).
12. Follow the procedure in [After working inside your computer](#).


## Palm-rest assembly

### Removing the palm-rest assembly


 **CAUTION:** The information in this removal section is intended for authorized service technicians only.

#### Prerequisites

1. Follow the procedure in [Before working inside your computer](#).
2. Remove the [base cover](#).
3. Remove the [battery](#).
4. Remove the [memory module](#).
5. Remove the [M.2 2230 solid-state drive](#) or [M.2 2280 solid-state drive](#), whichever is applicable.
6. Remove the [wireless card](#).
7. Remove the [speakers](#).
8. Remove the [fan](#).
9. Remove the [battery frame](#).
10. Remove the [USH board](#).
11. Remove the [smart card reader](#), if available.
12. Remove the [heat sink](#).


 **NOTE:** If you are removing the system board to replace/access other parts, you may remove the system board with the heat sink attached to it in order to simplify the procedure and preserve the thermal bond between the system board and heat sink.

13. Remove the [I/O board](#).
14. Remove the [power button](#).
15. Remove the [display assembly](#).
16. Remove the [system board](#).

 **NOTE:** If you are removing the system board to replace/access other parts, you may remove the system board with the heat sink attached to it in order to simplify the procedure and preserve the thermal bond between the system board and heat sink.

17. Remove the [keyboard](#).

#### About this task

 **NOTE:** The palm-rest assembly cannot be further disassembled once all the **Prerequisites** are completed. If the touchpad is malfunctioning and is required to be replaced, replace the entire palm-rest assembly.

The image below shows the palm-rest assembly after the **Prerequisites** have been performed.



Figure 91. Palm-rest assembly

### Steps

After performing the **Prerequisites**, you are left with the palm-rest assembly.

## Installing the palm-rest assembly

**CAUTION:** The information in this installation section is intended for authorized service technicians only.

### Prerequisites

If you are replacing a component, remove the existing component before performing the installation procedure.

### About this task

**NOTE:** The system board can be installed with the heat sink attached to it in order to simplify the procedure and preserve the thermal bond between the system board and heat sink.

The image below shows the palm-rest assembly.





**Figure 92. Palm-rest assembly**

### Steps

Place the palm-rest assembly on a flat surface and perform the **Next steps** to install the palm-rest assembly.

### Next steps

1. Install the [keyboard](#).
2. Install the [system board](#).
3. Install the [display assembly](#).
4. Install the [power button](#).
5. Install the [I/O board](#).
6. Install the [heat sink](#).
7. Install the [smart card reader](#), if available.
8. Install the [USH board](#).
9. Install the [battery frame](#).
10. Install the [fan](#).
11. Install the [speakers](#).
12. Install the [wireless card](#).
13. Install the [M.2 2230 solid-state drive](#) or [M.2 2280 solid-state drive](#), whichever is applicable.
14. Install the [memory module](#).
15. Install the [battery](#).
16. Install the [base cover](#).
17. Follow the procedure in [After working inside your computer](#).

# Software

This chapter details the supported operating systems along with instructions on how to install the drivers.

## Operating system

Your Dell Pro Max 14 MC14250 supports the following operating systems:

- Windows 11 Home
- Windows 11 Pro
- Ubuntu Linux 22.04 LTS, 64-bit

## Drivers and downloads

When troubleshooting, downloading, or installing drivers, it is recommended that you read the Dell Knowledge Base article [Drivers and Downloads FAQs 000123347](#).



# BIOS Setup

**NOTE:** Depending on the computer and the installed devices, the options that are listed in this section may or may not be displayed.

**CAUTION:** Certain changes can make your computer work incorrectly. Before you change the settings in BIOS Setup, it is recommended that you note down the original settings for future reference.

Use BIOS Setup for the following purposes:

- Get information about the hardware installed in your computer, such as the amount of RAM and the capacity of the storage device.
- Change the system configuration information.
- Set or change a user-selectable option, such as the user password, type of storage device that is installed, and enable or disable base devices.

## Entering BIOS Setup program

Turn on or restart your computer and press F2 immediately.

## Navigation keys

**NOTE:** For most of the BIOS Setup options, changes that you make are recorded but do not take effect until you restart the computer.

**Table 34. Navigation keys**

Keys	Navigation
Up arrow	Moves to the previous field.
Down arrow	Moves to the next field.
Enter	Selects a value in the selected field (if applicable) or follows the link in the field.
Spacebar	Expands or collapses a drop-down list, if applicable.
Tab	Moves to the next focus area.
Esc	Moves to the previous page until you view the main screen. Pressing Esc in the main screen displays a message that prompts you to save any unsaved changes and restart the computer.

## F12 One Time Boot menu

To enter the One Time Boot menu, turn on or restart your computer, and then press F12 immediately.

**NOTE:** If you are unable to enter the One Time Boot menu, repeat the above action.

The One Time Boot menu displays the devices that you can boot from and also display the options to start diagnostics. The boot menu options are:

- Windows Boot Manager
- UEFI M.2 solid state drive Boot

- UEFI HTTPs Boot
- Diagnostics

The One Time Boot menu screen also displays the option to access BIOS Setup.

## View Advanced Setup options

### About this task

Some BIOS Setup options are only visible by enabling **Advanced Setup** mode, which is disabled by default.

**NOTE:** BIOS Setup options, including **Advanced Setup** options, are described in the **System setup options** option.

### To enable Advanced Setup:

#### Steps

1. Enter BIOS Setup.  
The Overview menu appears.
2. Click the **Advanced Setup** option to move it to the **ON** mode.  
Advanced BIOS Setup options are displayed.

## View Service options

### About this task

Service options are hidden by default and only visible by entering a hotkey command.

**NOTE:** Service options are described in [BIOS Setup options](#).

### To view Service options:

#### Steps

1. Enter BIOS Setup.  
The Overview menu appears.
2. Enter the hotkey combination **Ctrl + Alt + s** to view the **Service** options.  
**Service** options are displayed.

## System Setup options



**NOTE:** For most of the System Setup options, changes that you make are recorded but do not take effect until you restart the computer.

**NOTE:** Depending on your computer and its installed devices, the items that are listed in this section may differ.

**Table 35. System Setup options—Overview menu**

Overview	
<b>Dell Pro Max 14 MC14250</b>	
BIOS Version	Displays the BIOS version number.
Service Tag	Displays the Service Tag of the computer.
Asset Tag	Displays the Asset Tag of the computer.
Manufacture Date	Displays the manufacture date of the computer.
Ownership Date	Displays the ownership date of the computer.





**Table 35. System Setup options—Overview menu (continued)**

<b>Overview</b>	
Express Service Code	Displays the Express Service Code of the computer.
Ownership Tag	Displays the Ownership Tag of the computer.
<b>BATTERY</b> Information	
Primary	Displays the primary battery of the computer.
Battery Level	Displays the battery level of the computer.
Battery State	Displays the battery state of the computer.
Health	Displays the battery health of the computer.
AC Adapter	Displays whether an AC adapter is connected. If connected, displays the type of AC adapter that is connected.
Battery Life Type	Standard
<b>PROCESSOR</b> Information	
Processor Type	Displays the processor type.
Maximum Clock Speed	Displays the maximum processor clock speed.  <b>NOTE:</b> To view this option, enable <b>Advanced Setup</b> mode as described in <a href="#">View Advanced Setup options</a> .
Core Count	Displays the total core count of the processor.
Processor ID	Displays the processor ID.
Processor L2 Cache	Displays the processor.
Processor L3 Cache	Displays the processor.
Microcode Version	Displays the microcode version of the processor.
Intel Hyper-Threading Capable	Displays whether the processor is Hyper-Threading (HT) capable or not.
Intel vPro Technology	Displays whether the processor is
<b>MEMORY</b> Information	
Memory Installed	Displays the total memory installed on the computer.
Memory Available	Displays the total memory available on the computer.
Memory Speed	Displays the memory speed.  <b>NOTE:</b> To view this option, enable <b>Advanced Setup</b> mode as described in <a href="#">View Advanced Setup options</a> .
Memory Technology	Displays the technology that is used for the memory.
DIMM_SLOT A	Displays the memory speed and memory slot type.
<b>DEVICES</b> Information	
Panel Type	Displays the type of display panel available on the computer.
Panel Revision	A0
Video Controller	Displays the type of video controller available on the computer.
Video Memory	Displays the video memory information of the computer.
Wi-Fi Device	Displays the wireless device information of the computer.
Native Resolution	Displays the native resolution of the computer.
Video BIOS Version	Displays the video BIOS version of the computer.
Audio Controller	Displays the audio controller information of the computer.

**Table 35. System Setup options—Overview menu (continued)**

Overview	
Bluetooth Device	Displays the Bluetooth device information of the computer.
LOM MAC Address	Displays the LOM MAC address of the computer.
Pass Through MAC Address	Displays the MAC address of the video pass-through.

**Table 36. System Setup options—Boot Configuration menu**

Boot Configuration	
<b>Boot Sequence</b>	
Boot Sequence	Displays the boot sequence.
Enable PXE Boot Priority	<p>When enabled, any new PXE boot option that is detected by the computer is added to the top of the Boot Sequence.</p> <p>By default, the <b>Enable PXE Boot Priority</b> option is disabled.</p>
<b>Secure Boot</b>	
	<p>Secure Boot is a method of guaranteeing the integrity of the boot path by performing additional validation of the operating system and PCI add-in cards. The computer stops booting to the operating system when a component is not authenticated during the boot process. Secure Boot can be enabled in BIOS setup or using management interfaces like Dell Command Configure, but can only be disabled from BIOS setup.</p>
Enable Secure Boot	<p>Enables the computer to boot using only validated boot software.</p> <p>By default, this <b>Enable Secure Boot</b> option is disabled. For additional security, Dell Technologies recommends keeping the <b>Secure Boot</b> option enabled to ensure that the UEFI firmware validates the operating system during the boot process.</p> <p> <b>NOTE:</b> To view this option, enable <b>Advanced Setup</b> mode as described in <a href="#">View Advanced Setup options</a>.</p> <p> <b>NOTE:</b> To enable Secure Boot, the computer must be in UEFI boot mode and the Enable Legacy Option ROMs option must be turned off.</p>
Enable Microsoft UEFI CA	<p>When disabled, the UEFI CA is removed from the BIOS UEFI Secure Boot database.</p> <p> <b>CAUTION:</b> If you disable Microsoft UEFI CA, the computer may not boot, computer graphics may not function, some devices may not function properly, and the computer could become unrecoverable.</p> <p>By default, the <b>Enable Microsoft UEFI CA</b> option is enabled.</p> <p>For additional security, Dell Technologies recommends keeping the <b>Enable Microsoft UEFI CA</b> option enabled to ensure the broadest compatibility with devices and operating systems.</p>
Secure Boot Mode	<p>Enables or disables the Secure Boot operation mode.</p> <p>By default, the <b>Deployed Mode</b> is selected. <b>Deployed Mode</b> should be selected for normal operation of Secure Boot.</p> <p> <b>NOTE:</b> To view this option, enable <b>Advanced Setup</b> mode as described in <a href="#">View Advanced Setup options</a>.</p>
<b>Expert Key Management</b>	
Enable Custom Mode	<p>Enables or disables the keys in the PK, KEK, db, and dbx security key databases to be modified.</p> <p>By default, the <b>Enable Custom Mode</b> option is disabled.</p>

**Table 36. System Setup options—Boot Configuration menu (continued)**


<b>Boot Configuration</b>	
	<p><b>i</b> <b>NOTE:</b> To view this option, enable <b>Advanced Setup</b> mode as described in <a href="#">View Advanced Setup options</a>.</p>
Custom Mode Key Management	<p>Selects the custom values for expert key management.</p> <p>By default, the <b>PK</b> option is selected.</p> <p><b>i</b> <b>NOTE:</b> To view this option, enable <b>Advanced Setup</b> mode as described in <a href="#">View Advanced Setup options</a>.</p>

**Table 37. System Setup options—Integrated Devices menu**

<b>Integrated Devices</b>	
<b>Date/Time</b>	
Date	Sets the computer date in MM/DD/YYYY format. Changes to the date format take effect immediately.
Time	Sets the computer time in HH/MM/SS 24-hour format. You can select between a 12-hour or 24-hour clock. Changes to the time format take effect immediately.
<b>Camera</b>	
Enable Camera	<p>Enables the camera.</p> <p>By default, the <b>Enable Camera</b> option is enabled.</p> <p><b>i</b> <b>NOTE:</b> Depending on the configuration ordered, the camera setup option may not be available.</p>
<b>Audio</b>	
Enable Audio	<p>Enables all integrated audio controller.</p> <p>By default, all the options are enabled.</p>
Enable Microphone	<p>Enables the microphone.</p> <p>By default, the <b>Enable Microphone</b> option is enabled.</p> <p><b>i</b> <b>NOTE:</b> Depending on the configuration ordered, the microphone setup option may not be available.</p>
Enable Internal Speaker	<p>Enables the internal speaker.</p> <p>By default, the <b>Enable Internal Speaker</b> option is enabled.</p>
<b>USB/Thunderbolt Configuration</b>	
Enable External USB Ports	<p>Enables the external USB ports.</p> <p>By default, the <b>Enable External USB Ports</b> option is enabled.</p> <p><b>i</b> <b>NOTE:</b> To view this option, enable <b>Advanced Setup</b> mode as described in <a href="#">View Advanced Setup options</a>.</p>
Enable USB Boot Support	<p>Enables booting from USB mass storage devices that are connected to external USB ports.</p> <p>By default, the <b>Enable USB Boot Support</b> option is enabled.</p> <p><b>i</b> <b>NOTE:</b> To view this option, enable <b>Advanced Setup</b> mode as described in <a href="#">View Advanced Setup options</a>.</p>
<b>Enable Thunderbolt Technology Support</b>	<p>Enables the associated ports and adapters for Thunderbolt Technology support.</p> <p>By default, the <b>Enable Thunderbolt Technology Support</b> option is enabled.</p>



**Table 37. System Setup options—Integrated Devices menu (continued)**

<b>Integrated Devices</b>	
	<p> <b>NOTE:</b> To view this option, enable <b>Advanced Setup</b> mode as described in <a href="#">View Advanced Setup options</a>.</p>
<b>Enable Thunderbolt Boot Support</b>	<p>Enables the Thunderbolt adapter-peripheral device and USB devices that are connected to the Thunderbolt adapter to be used during BIOS Preboot.</p> <p>By default, the <b>Enable Thunderbolt Boot Support</b> option is disabled.</p> <p> <b>NOTE:</b> To view this option, enable <b>Advanced Setup</b> mode as described in <a href="#">View Advanced Setup options</a>.</p>
<b>Disable USB4 PCIE Tunneling</b>	<p>Disables the USB4 PCIE Tunneling option.</p> <p>By default, the <b>Disable USB4 PCIE Tunneling</b> option is disabled.</p> <p> <b>NOTE:</b> To view this option, enable <b>Advanced Setup</b> mode as described in <a href="#">Entering BIOS Setup program</a>.</p>
<b>Video/Power only on Type-C Ports</b>	<p>Enables or disables the Type-C port functionality to video or only power.</p> <p>By default, the <b>Video/Power only on Type-C Ports</b> option is disabled.</p> <p> <b>NOTE:</b> To view this option, enable <b>Advanced Setup</b> mode as described in <a href="#">View Advanced Setup options</a>.</p>
<b>Type-C Dock</b>	
Type-C Dock Override	<p>Enables or disables to use connected Type-C Dell Dock to provide data stream with external USB ports disabled. When Type-C Dock override is enabled, the Video/Audio/LAN submenu is activated.</p> <p>By default, the <b>Type-C Dock Override</b> option is enabled.</p> <p> <b>NOTE:</b> To view this option, enable <b>Advanced Setup</b> mode as described in <a href="#">Entering BIOS Setup program</a>.</p>
Type-C Dock Audio	<p>Enables or disables the usage of audio inputs and outputs from the connected Type-C Dell docking station.</p> <p>By default, the <b>Type-C Dock Audio</b> option is enabled.</p> <p> <b>NOTE:</b> To view this option, enable <b>Advanced Setup</b> mode as described in <a href="#">View Advanced Setup options</a>.</p>
Type-C Dock LAN	<p>Enables or disables the usage of LAN on the external ports of the connected Type-C Dell docking station.</p> <p>By default, the <b>Type-C Dock LAN</b> option is enabled.</p> <p> <b>NOTE:</b> To view this option, enable <b>Advanced Setup</b> mode as described in <a href="#">View Advanced Setup options</a>.</p>
<b>Miscellaneous Devices</b>	
Enable Fingerprint Reader Device	<p>Enables or disables the Fingerprint Reader Device option.</p> <p>By default, the <b>Enable Fingerprint Reader Device</b> option is enabled.</p> <p> <b>NOTE:</b> To view this option, enable <b>Advanced Setup</b> mode as described in <a href="#">View Advanced Setup options</a>.</p>
<b>Unobtrusive Mode</b>	
Enable Unobtrusive Mode	<p>Enables or disables the unobtrusive mode. When enabled, all system LEDs, LCD panel backlight and audio devices of the computer are turned off.</p> <p>By default, the <b>Enable Unobtrusive Mode</b> option is disabled.</p>

**Table 37. System Setup options—Integrated Devices menu (continued)**

Integrated Devices	
	<p><b>i</b> <b>NOTE:</b> On computers with collaboration touchpad, the Collaboration Touchpad is disabled when the <b>Enable Unobtrusive Mode</b> option is enabled.</p> <p><b>i</b> <b>NOTE:</b> To view this option, enable <b>Advanced Setup</b> mode as described in <a href="#">View Advanced Setup options</a>.</p>

**Table 38. System Setup options—Storage menu**

Storage	
<b>SATA/NVMe Operation</b>	<p>Sets the operating mode of the integrated SATA hard drive controller.</p> <p>By default, the <b>RAID On</b> option is selected.</p>
<b>Storage Interface</b>	<p>Displays the information of various onboard drives.</p>
Port Enablement	<p>Enables or disables the M.2 PCIe SSD option.</p> <p>By default, the <b>M.2 PCIe SSD-1</b> option is enabled.</p>
<b>SMART Reporting</b>	
Enable SMART Reporting	<p>Enables or disables the SMART reporting option.</p> <p>By default, the <b>Enable SMART Reporting</b> option is disabled.</p> <p><b>i</b> <b>NOTE:</b> To view this option, enable <b>Advanced Setup</b> mode as described in <a href="#">View Advanced Setup options</a>.</p>
<b>Drive Information</b>	<p>Displays the information of onboard drives.</p>




**Table 39. System Setup options—Display menu**

Display	
<b>Display Brightness</b>	
Brightness on battery power	<p>By default, the screen brightness is set to 50 when the computer is running on battery power. Set the screen brightness when the computer is running on battery power.</p> <p><b>i</b> <b>NOTE:</b> To view this option, enable <b>Advanced Setup</b> mode as described in <a href="#">View Advanced Setup options</a>.</p>
Brightness on AC power	<p>By default, the screen brightness is set to 100 when the computer is running on AC power. Set the screen brightness when the computer is running on AC power.</p> <p><b>i</b> <b>NOTE:</b> To view this option, enable <b>Advanced Setup</b> mode as described in <a href="#">View Advanced Setup options</a>.</p>
<b>Touchscreen</b>	<p>Enables or disables the touch screen option.</p> <p>By default, the <b>Touchscreen</b> option is enabled.</p> <p><b>i</b> <b>NOTE:</b> Only available on computers with touch screen displays.</p> <p><b>i</b> <b>NOTE:</b> To view this option, enable <b>Advanced Setup</b> mode as described in <a href="#">View Advanced Setup options</a>.</p>
<b>Full Screen Logo</b>	<p>Enables or disables the computer to display full screen logo, if the image matches screen resolution.</p> <p>By default, the <b>Full Screen Logo</b> option is disabled.</p> <p><b>i</b> <b>NOTE:</b> To view this option, enable <b>Advanced Setup</b> mode as described in <a href="#">View Advanced Setup options</a>.</p>



**Table 40. System Setup options—Connection menu**

<b>Connection</b>	
<b>Network Controller Configuration</b>	
Integrated NIC	Enables or disables the onboard LAN controller. By default, the <b>Integrated NIC</b> option is set to <b>Enabled with PXE</b> .
<b>Wireless Device Enable</b>	
WLAN	Enables or disables the internal WLAN device. By default, the <b>WLAN</b> option is enabled.
Bluetooth	Enables or disables the internal Bluetooth device. By default, the <b>Bluetooth</b> option is enabled.
Contactless smartcard/NFC	Enables or disables the smartcard device. By default, the <b>Contactless smartcard/NFC</b> option is enabled.  <b>i</b> <b>NOTE:</b> To view this option, enable <b>Advanced Setup</b> mode as described in <a href="#">View Advanced Setup options</a> .
<b>Enable UEFI Network Stack</b>	Enables or disables the UEFI Network Stack and controls the onboard LAN Controller. By default, the <b>Enable UEFI Network Stack</b> option is set to <b>Auto Enabled</b> .  <b>i</b> <b>NOTE:</b> To view this option, enable <b>Advanced Setup</b> mode as described in <a href="#">View Advanced Setup options</a> .
<b>Wireless Radio Control</b>	
Control WLAN Radio	Enable to sense the connection of the computer to a wired network and then disables the selected WLAN radio. Upon disconnection from the wired network, the selected wireless radios are reenabled. By default, the <b>Control WLAN Radio</b> option is disabled.  <b>i</b> <b>NOTE:</b> To view this option, enable <b>Advanced Setup</b> mode as described in <a href="#">View Advanced Setup options</a> .
<b>Enable UEFI Bluetooth Stack</b>	Enables or disables the UEFI Bluetooth Stack. When enabled, UEFI Bluetooth protocols are installed and are available, allowing pre-OS Bluetooth HID features. By default, the <b>Enable UEFI Bluetooth Stack</b> option is enabled.
<b>HTTP(s) Boot Feature</b>	
HTTP(s) Boot	When enabled, supports HTTP(s) boot on the client BIOS, which offers wired or wireless and HTTP/HTTPS connection options. By default, the <b>HTTP(s) Boot</b> option is enabled.

**Table 40. System Setup options—Connection menu (continued)**

Connection	
	<p> <b>NOTE:</b> To view this option, enable <b>Advanced Setup</b> mode as described in <a href="#">View Advanced Setup options</a>.</p>
HTTP(s) Boot Modes	<p>In Auto Mode, the boot URL is obtained from the DHCP response; the boot URL specifies the HTTP Boot Server and location of the Network Boot Program (NBP) file. In Manual mode, the user enters the URL in the text box, which must start with <code>http://</code> or <code>https://</code> and end with the NBP file name.</p> <p>By default, <b>Auto Mode</b> is selected.</p> <p> <b>NOTE:</b> To view this option, enable <b>Advanced Setup</b> mode as described in <a href="#">View Advanced Setup options</a>.</p>
CA Certificate	<p>Upload or delete the CA certificate.</p> <p> <b>NOTE:</b> To view this option, enable <b>Advanced Setup</b> mode as described in <a href="#">View Advanced Setup options</a>.</p>

**Table 41. System Setup options—Power menu**

Power	
<b>Battery Configuration</b>	<p>Enables or disables the computer to run on battery during peak power usage hours. Use the table <b>Custom Charge Start</b> and <b>Custom Charge Stop</b>, to prevent AC power usage between certain times of each day.</p> <p>By default, the <b>Adaptive</b> option is selected. Battery settings are adaptively optimized based on your typical battery usage pattern.</p>
<b>Advanced Configuration</b>	
Enable Advanced Battery Charge Configuration	<p>Enables Advanced Battery Charge Configuration from the beginning of the day to a specified work period. When enabled, Advanced Battery Charged maximizes battery health while still supporting heavy use during the work day.</p> <p>By default, the <b>Enable Advanced Battery Charge Configuration</b> option is disabled.</p> <p> <b>NOTE:</b> To view this option, enable <b>Advanced Setup</b> mode as described in <a href="#">View Advanced Setup options</a>.</p>
<b>Peak Shift</b>	
Enable Peak Shift	<p>Enables or disables the computer to run on battery during peak power usage hours.</p> <p>By default, the <b>Enable Peak Shift</b> option is disabled.</p> <p> <b>NOTE:</b> To view this option, enable <b>Advanced Setup</b> mode as described in <a href="#">View Advanced Setup options</a>.</p>
<b>Type-C Connector Power</b>	<p>Allows you to set the maximum power that can be drawn from the Type-C connector.</p> <p>By default, the <b>Type-C Connector Power</b> option is set to 7.5 W.</p>
<b>USB PowerShare</b>	
Enable USB PowerShare	<p>Enables or disables the USB PowerShare on the computer.</p> <p>By default, the <b>Enable USB PowerShare</b> option is disabled.</p>

**Table 41. System Setup options—Power menu (continued)**

<b>Power</b>	
<b>Thermal Management</b>	<p>This setting allows for cooling of fan and processor heat management to adjust system performance, noise and temperature.</p> <p>By default, the <b>Optimized</b> option is selected.</p>
<b>USB Wake Support</b>	
Wake on Dell USB-C Dock	<p>When enabled, connecting a Dell USB-C Dock wakes the computer from Standby, Hibernate, and Power Off.</p> <p>By default, the <b>Wake on Dell USB-C Dock</b> option is enabled.</p> <p><b>i</b> <b>NOTE:</b> To view this option, enable <b>Advanced Setup</b> mode as described in <a href="#">View Advanced Setup options</a>.</p>
<b>Block Sleep</b>	<p>Enables or disables the computer from entering Sleep (S3) mode in the operating system.</p> <p>By default, the <b>Block Sleep</b> option is disabled.</p> <p><b>i</b> <b>NOTE:</b> When enabled, the computer does not go to Sleep, Intel Rapid Start is disabled automatically, and the operating system power option is blank if it was set to Sleep.</p> <p><b>i</b> <b>NOTE:</b> To view this option, enable <b>Advanced Setup</b> mode as described in <a href="#">View Advanced Setup options</a>.</p>
<b>Lid Switch</b>	
Enable Lid Switch	<p>Enables or disables the Lid Switch.</p> <p>By default, the <b>Enable Lid Switch</b> option is enabled.</p>
Power On Lid Open	<p>When enabled, allows the computer to turn on from the off state whenever the lid is opened.</p> <p>By default, the <b>Power On Lid Open</b> option is enabled.</p>

**Table 42. System Setup options—Security menu**









<b>Security</b>	
<b>TPM 2.0 Security</b>	<p>Trusted Platform Module (TPM) is a security device that stores computer-generated keys for encryption and features such as BitLocker, Virtual Secure Mode, remote Attestation.</p> <p>By default, the <b>TPM 2.0 Security</b> option is enabled.</p> <p>For additional security, Dell Technologies recommends keeping the Trusted Platform Module (TPM) enabled to allow these security technologies to fully function.</p>
TPM 2.0 Security On	<p>Enables or disables the TPM.</p> <p>By default, the <b>TPM 2.0 Security On</b> option is enabled.</p> <p>For additional security, Dell Technologies recommends keeping TPM enabled to allow these security technologies to fully function.</p> <p><b>i</b> <b>NOTE:</b> To view this option, enable <b>Advanced Setup</b> mode as described in <a href="#">View Advanced Setup options</a>.</p>
Attestation Enable	<p>The <b>Attestation Enable</b> option controls the endorsement hierarchy of TPM. Disabling the <b>Attestation Enable</b> option prevents TPM from being used to digitally sign certificates.</p> <p>By default, the <b>Attestation Enable</b> option is enabled.</p> <p>For additional security, Dell Technologies recommends keeping the <b>Attestation Enable</b> option enabled.</p>



**Table 42. System Setup options—Security menu (continued)**

<b>Security</b>	
	<p><b>i</b> <b>NOTE:</b> When disabled, this feature may cause compatibility issues or loss of functionality in some operating systems.</p> <p><b>i</b> <b>NOTE:</b> To view this option, enable <b>Advanced Setup</b> mode as described in <a href="#">View Advanced Setup options</a>.</p>
Key Storage Enable	<p>The <b>Key Storage Enable</b> option controls the storage hierarchy of TPM, which is used to store digital keys. Disabling the <b>Key Storage Enable</b> option restricts the ability of TPM to store owner's data.</p> <p>By default, the <b>Key Storage Enable</b> option is enabled.</p> <p>For additional security, Dell Technologies recommends keeping the <b>Key Storage Enable</b> option enabled.</p> <p><b>i</b> <b>NOTE:</b> When disabled, this feature may cause compatibility issues or loss of functionality in some operating systems.</p> <p><b>i</b> <b>NOTE:</b> To view this option, enable <b>Service</b> options as described in <a href="#">View Service options</a>.</p>
Clear	<p>When enabled, the <b>Clear</b> option clears information that is stored in the TPM after exiting the system's BIOS. This option returns to the disabled state when the computer restarts.</p> <p>By default, the <b>Clear</b> option is disabled.</p> <p>Dell Technologies recommends enabling the <b>Clear</b> option only when TPM data is required to be cleared.</p> <p><b>i</b> <b>NOTE:</b> To view this option, enable <b>Advanced Setup</b> mode as described in <a href="#">View Advanced Setup options</a>.</p>
Physical Presence Interface (PPI) Bypass for Clear Commands	<p>The PPI Bypass for Clear Commands option allows the operating system to manage certain aspects of PTT. When enabled, you are not prompted to confirm changes to the PTT configuration.</p> <p>By default, the <b>PPI Bypass for Clear Commands</b> option is disabled.</p> <p>For additional security, Dell Technologies recommends keeping the <b>PPI Bypass for Clear Commands</b> option disabled.</p>
<b>Intel Total Memory Encryption</b>	<p>Enables or disables the processor's memory encryption feature.</p> <p>By default, the <b>Intel Total Memory Encryption</b> option is disabled.</p> <p><b>i</b> <b>NOTE:</b> To view this option, enable <b>Advanced Setup</b> mode as described in <a href="#">View Advanced Setup options</a>.</p>
<b>Chassis Intrusion</b>	
Chassis Intrusion	<p>Enables or disables the detection of chassis intrusion events. This feature notifies the user when the base cover has been removed from the computer.</p> <p>When set to <b>Enabled</b>, a notification is displayed on the next boot and the event is logged in the BIOS Events log.</p> <p>When set to <b>Disabled</b>, no notification is displayed and no event is logged in the BIOS Events log.</p> <p>When set to <b>On-Silent</b>, the event is logged in the BIOS Events log, but no notification is displayed.</p> <p>By default, the <b>Chassis Intrusion Detection</b> option is disabled.</p> <p>For additional security, Dell Technologies recommends keeping the <b>Chassis Intrusion</b> option enabled.</p>

**Table 42. System Setup options—Security menu (continued)**

<b>Security</b>	
	<p> <b>NOTE:</b> To view this option, enable <b>Advanced Setup</b> mode as described in <a href="#">View Advanced Setup options</a>.</p>
Block Boot Until Cleared	<p>The <b>Block Boot Until Clear</b> option is enabled when <b>Chassis Intrusion</b> is enabled. When enabled, the computer does not boot until the chassis intrusion is cleared.</p> <p> <b>NOTE:</b> To view this option, enable <b>Advanced Setup</b> mode as described in <a href="#">View Advanced Setup options</a>.</p>
<b>Data Wipe on Next Boot</b>	
Start Data Wipe	<p>Data Wipe is a secure wipe operation that deletes information from a storage device.</p> <p> <b>WARNING: The Secure Data Wipe operation deletes information in a way that it cannot be reconstructed.</b></p> <p>Commands such as delete and format in the operating system may remove files from showing up in the file system. However, they can be reconstructed through forensic means as they are still represented on the physical media. Data Wipe prevents this reconstruction and the data can no longer be recovered.</p> <p>When enabled, the data wipe option provides prompts to wipe any storage devices that are connected to the computer on the next boot.</p> <p>By default, the <b>Start Data Wipe</b> option is disabled.</p> <p> <b>NOTE:</b> To view this option, enable <b>Advanced Setup</b> mode as described in <a href="#">View Advanced Setup options</a>.</p>
<b>Absolute</b>	
	<p>Absolute Software provides various cyber security solutions, some requiring software preloaded on Dell computers and integrated into the BIOS. To use these features, you must enable the Absolute BIOS setting and contact Absolute for configuration and activation.</p> <p>By default, the <b>Absolute</b> option is enabled.</p> <p>For additional security, Dell Technologies recommends keeping the <b>Absolute</b> option enabled.</p> <p> <b>WARNING: The Permanently Disabled option can only be selected once. When Permanently Disabled is selected, Absolute Persistence cannot be reenabled. No further changes to the Enable/Disable states are allowed.</b></p> <p> <b>NOTE:</b> The Enable/Disable options are unavailable while the computer is in the activated state.</p> <p> <b>NOTE:</b> When the Absolute features are activated, the Absolute integration cannot be disabled from the BIOS Setup screen.</p>
<b>UEFI Boot Path Security</b>	
	<p>Enables or disables the computer to prompt the user to enter the Administrator password (if set) when booting to a UEFI boot path device from the F12 boot menu.</p> <p>By default, the <b>Always Except Internal HDD</b> option is enabled.</p> <p> <b>NOTE:</b> To view this option, enable <b>Advanced Setup</b> mode as described in <a href="#">View Advanced Setup options</a>.</p>
<b>Authenticated BIOS Interface</b>	
Enable Authenticated BIOS Interface	<p>Enables or disables the authenticated BIOS Interface.</p> <p>By default, the <b>Enable Authenticated BIOS Interface</b> option is disabled.</p>




**Table 42. System Setup options—Security menu (continued)**

Security	
Clear Certificate Store	<p><b>NOTE:</b> To view this option, enable <b>Advanced Setup</b> mode as described in <a href="#">View Advanced Setup options</a>.</p> <p>Deletes the certificates from KMS storage.</p>
Legacy Manageability Interface Access	<p><b>NOTE:</b> To view this option, enable <b>Advanced Setup</b> mode as described in <a href="#">View Advanced Setup options</a>.</p> <p>Allows access to the Legacy Manageability Interface.</p> <p><b>NOTE:</b> To view this option, enable <b>Advanced Setup</b> mode as described in <a href="#">View Advanced Setup options</a>.</p>
<b>Firmware Device Tamper Detection</b>	<p>Allows you to control the firmware device tamper detection feature. This feature notifies the user when the firmware device is tampered. When enabled, a screen warning message is displayed on the computer and a tamper detection event is logged in the BIOS Events log. The computer fails to reboot until the event is cleared.</p> <p>By default, the <b>Firmware Device Tamper Detection</b> option is enabled.</p> <p>For additional security, Dell Technologies recommends keeping the <b>Firmware Device Tamper Detection</b> option enabled.</p> <p><b>NOTE:</b> To view this option, enable <b>Advanced Setup</b> mode as described in <a href="#">View Advanced Setup options</a>.</p>
Clear Firmware Device Tamper Detection	<p>Allows you to clear the events that are logged when tampering of firmware device is detected.</p> <p>By default, the <b>Clear Firmware Device Tamper Detection</b> option is disabled.</p> <p><b>NOTE:</b> To view this option, enable <b>Advanced Setup</b> mode as described in <a href="#">View Advanced Setup options</a>.</p>

**Table 43. System Setup options—Passwords menu**

Passwords	
<b>Admin Password</b>	<p>The Administrator Password prevents unauthorized access to the BIOS Setup options. Once the administrator password is set, the BIOS Setup options can only be modified after providing the correct password.</p> <p>The following rules and dependencies apply to the Administrator Password -</p> <ul style="list-style-type: none"> <li>• The administrator password cannot be set if system and/or internal storage passwords are previously set.</li> <li>• The administrator password can be used in place of the system and/or internal storage passwords.</li> <li>• When set, the administrator password must be provided during a firmware update.</li> <li>• Clearing the administrator password also clears the system password (if set).</li> </ul> <p>Dell Technologies recommends using an administrator password to prevent unauthorized changes to BIOS Setup options.</p>
<b>System Password</b>	<p>The System Password prevents the computer from booting to an operating system without entering the correct password.</p> <p>The following rules and dependencies apply when the System Password is used -</p> <ul style="list-style-type: none"> <li>• The computer shuts down when idle for approximately 10 minutes at the system password prompt.</li> <li>• The computer shuts down after three incorrect attempts to enter the system password.</li> </ul>

**Table 43. System Setup options—Passwords menu (continued)**

<p><b>Passwords</b></p>	<ul style="list-style-type: none"> <li>• The computer shuts down when the <b>Esc</b> key is pressed at the <b>System Password</b> prompt.</li> <li>• The system password is not prompted when the computer resumes from standby mode.</li> </ul> <p>Dell Technologies recommends using the system password in situations where it is likely that a computer may be lost or stolen.</p>
<p><b>M.2 PCIe SSD-1</b></p>	<p>The M.2 PCIe SSD-1 password prevents the computer from booting to an operating system without entering the correct password.</p> <p>The following rules and dependencies apply when the System Password is used -</p> <ul style="list-style-type: none"> <li>• The computer shuts down when idle for approximately 10 minutes at the system password prompt.</li> <li>• The computer shuts down after three incorrect attempts to enter the system password.</li> <li>• The computer shuts down when the <b>Esc</b> key is pressed at the <b>System Password</b> prompt.</li> <li>• The system password is not prompted when the computer resumes from standby mode.</li> </ul> <p>Dell Technologies recommends using the system password in situations where it is likely that a computer may be lost or stolen.</p>
<p><b>Password Configuration</b></p>	<p>The Password Configuration page includes several options for changing the requirements of BIOS passwords. You can modify the minimum and maximum length of the passwords as well as require passwords to contain certain character classes (upper case, lower case, digit, special character).</p> <p>When the <b>Lower Case Letter</b> option is enabled, the password requires at least one lower case letter.</p> <p>When the <b>Upper Case Letter</b> option is enabled, the password requires at least one upper case letter.</p> <p>When the <b>Digit</b> option is enabled, the password requires at least one numeric digit.</p> <p>When the <b>Special Character</b> option is enabled, the password requires at least one special character from the set: !"#%&amp;'()*+,-./:;&lt;=&gt;?@[\\]^_`{ }~.</p> <p>When setting <b>Minimum Characters</b> for password length, Dell Technologies recommends setting the minimum password length to at least eight characters.</p> <p> <b>NOTE:</b> To view this option, enable <b>Advanced Setup</b> mode as described in <a href="#">View Advanced Setup options</a>.</p>
<p><b>Password Bypass</b></p>	<p>The <b>Password Bypass</b> option allows the computer to reboot from the operating system without entering the system or hard drive password. If the computer has already booted to the operating system, it is presumed that the user has already entered the correct system or hard drive password.</p> <p> <b>NOTE:</b> This option does not remove the requirement to enter the password after shutting down.</p> <p>By default, the <b>Password Bypass</b> option is disabled.</p> <p>For additional security, Dell Technologies recommends keeping the <b>Password Bypass</b> option enabled.</p> <p> <b>NOTE:</b> To view this option, enable <b>Advanced Setup</b> mode as described in <a href="#">View Advanced Setup options</a>.</p>
<p><b>Password Changes</b></p>	
<p>Allow Non-Admin Password Changes</p>	<p>The <b>Allow Non-Admin Password Changes</b> option in BIOS Setup allows an end user to set or change the system or hard drive passwords without entering</p>

**Table 43. System Setup options—Passwords menu (continued)**

<b>Passwords</b>	
	<p>the administrator password. This gives an administrator control over the BIOS settings but enables an end user to provide their own password.</p> <p>By default, the <b>Allow Non-Admin Password Changes</b> option is enabled.</p> <p>For additional security, Dell Technologies recommends keeping the <b>Allow Non-Admin Password Changes</b> option disabled.</p> <p><b>NOTE:</b> To view this option, enable <b>Advanced Setup</b> mode as described in <a href="#">View Advanced Setup options</a>.</p>
<b>Admin Setup Lockout</b>	
Enable Admin Setup Lockout	<p>The <b>Admin Setup Lockout</b> option prevents an end user from even viewing the BIOS Setup configuration without first entering the administrator password (if set).</p> <p>By default, the <b>Enable Admin Setup Lockout</b> option is disabled.</p> <p>For additional security, Dell Technologies recommends keeping the <b>Admin Setup Lockout</b> option disabled.</p> <p><b>NOTE:</b> To view this option, enable <b>Advanced Setup</b> mode as described in <a href="#">View Advanced Setup options</a>.</p>
<b>Master Password Lockout</b>	
Enable Master Password Lockout	<p>The <b>Master Password Lockout</b> option allows you to disable the Recovery Password feature. If the system, administrator, or hard drive password is forgotten, the computer becomes unusable.</p> <p><b>NOTE:</b> When the owner password is set, the Master Password Lockout option is not available.</p> <p><b>NOTE:</b> When an internal hard drive password is set, it must first be cleared before Master Password Lockout can be changed.</p> <p>By default, the <b>Enable Master Password Lockout</b> option is disabled.</p> <p>Dell Technologies does not recommend enabling the <b>Master Password Lockout</b> unless you have implemented your own password recovery system.</p> <p><b>NOTE:</b> To view this option, enable <b>Advanced Setup</b> mode as described in <a href="#">View Advanced Setup options</a>.</p>
<b>Allow Non-Admin PSID Revert</b>	
Enable Allow Non-Admin PSID Revert	<p>The <b>Allow Non-Admin PSID Revert</b> option allows a user to clear the hard drive password without entering the BIOS Admin Password. When an Admin Password is set, the ability to enter the PSID is protected by requiring authentication with the Admin Password. If this option is enabled, any user can clear the drive without entering the Admin Password.</p> <p>By default, the <b>Enable Allow Non-Admin PSID Revert</b> option is disabled.</p> <p><b>NOTE:</b> To view this option, enable <b>Advanced Setup</b> mode as described in <a href="#">View Advanced Setup options</a>.</p>

**Table 44. System Setup options—Update, Recovery menu**

<b>Update, Recovery</b>	
<b>BIOS Recovery from Hard Drive</b>	<p>Enables or disables the user to recover from certain corrupted BIOS conditions from a recovery file on the user primary hard drive or an external USB drive.</p> <p>By default, the <b>BIOS Recovery from Hard Drive</b> option is enabled.</p>



**Table 44. System Setup options—Update, Recovery menu (continued)**

<b>Update, Recovery</b>	
	<p><b>i</b> <b>NOTE:</b> BIOS Recovery from Hard Drive is not available for self-encrypting drives (SED).</p> <p><b>i</b> <b>NOTE:</b> BIOS recovery is designed to fix the main BIOS block and cannot work if the Boot Block is damaged. In addition, this feature cannot work in the event of EC corruption, ME corruption, or a hardware issue. The recovery image must exist on an unencrypted partition on the drive.</p> <p><b>i</b> <b>NOTE:</b> To view this option, enable <b>Advanced Setup</b> mode as described in <a href="#">View Advanced Setup options</a>.</p>
<b>BIOS Downgrade</b>	
Allow BIOS Downgrade	<p>Allows downgrading of the system firmware to previous revisions.</p> <p>By default, the <b>Allow BIOS Downgrade</b> option is enabled.</p>
<b>SupportAssist OS Recovery</b>	
	<p>Enables or disables the boot flow for SupportAssist OS Recovery tool if certain system errors occur.</p> <p>By default, the <b>SupportAssist OS Recovery</b> option is enabled.</p>
<b>BIOSConnect</b>	
	<p>Enables or disables cloud service operating system recovery if the main operating system fails to boot with the number of failures equal to or greater than the value specified by the Auto OS Recovery Threshold setup option and local service operating system does not boot or is not installed.</p> <p>By default, the <b>BIOSConnect</b> option is enabled.</p>
<b>Dell Auto OS Recovery Threshold</b>	
	<p>Allows the control of the automatic boot flow for the SupportAssist System Resolution Console and the Dell OS Recovery Tool.</p> <p>By default, the <b>Dell Auto OS Recovery Threshold</b> value is set to <b>2</b>.</p> <p><b>i</b> <b>NOTE:</b> To view this option, enable <b>Advanced Setup</b> mode as described in <a href="#">View Advanced Setup options</a>.</p>

**Table 45. System Setup options—System Management menu**

<b>System Management</b>	
<b>Service Tag</b>	Displays the Service Tag of the computer.
<b>Asset Tag</b>	<p>Creates a computer Asset Tag that an IT administrator can use to uniquely identify a particular computer.</p> <p><b>i</b> <b>NOTE:</b> Once set in the BIOS, the Asset Tag cannot be changed.</p>
<b>AC Behavior</b>	
Wake on AC	<p>Enables or disables the computer to turn on and go to boot when AC power is supplied to the computer.</p> <p>By default, the <b>Wake on AC</b> option is disabled.</p> <p><b>i</b> <b>NOTE:</b> To view this option, enable <b>Advanced Setup</b> mode as described in <a href="#">View Advanced Setup options</a>.</p>
<b>Wake on LAN</b>	<p>Enables or disables the computer to turn on by a special LAN signal.</p> <p>By default, the <b>Wake on LAN</b> option is disabled.</p> <p><b>i</b> <b>NOTE:</b> To view this option, enable <b>Advanced Setup</b> mode as described in <a href="#">View Advanced Setup options</a>.</p>

**Table 45. System Setup options—System Management menu (continued)**

<b>System Management</b>	
<b>Auto On Time</b>	<p>Enable to set the computer to turn on automatically every day or on a preselected date and time. This option can be configured only if the Auto On Time is set to Everyday, Weekdays, or Selected Days.</p> <p>By default, the <b>Auto On Time</b> option is disabled.</p> <p><b>i</b> <b>NOTE:</b> To view this option, enable <b>Advanced Setup</b> mode as described in <a href="#">View Advanced Setup options</a>.</p>
<b>Intel AMT capability</b>	<p>Enable Intel AMT capability</p> <p>Configure Intel Active Management Technology (AMT) options, which can be enabled, disabled, or restricted.</p> <p><b>i</b> <b>NOTE:</b> To view this option, enable <b>Advanced Setup</b> mode as described in <a href="#">View Advanced Setup options</a>.</p>
<b>First Power On Date</b>	<p>Set Ownership Date</p> <p>Enables setting up ownership date.</p> <p>By default, the <b>Set Ownership Date</b> option is disabled.</p>
<b>Diagnostics</b>	<p>OS Agent Requests</p> <p>Enable or disable the option for applications running in the operating system to run with preboot diagnostics on subsequent boots.</p> <p><b>i</b> <b>NOTE:</b> To view this option, enable <b>Advanced Setup</b> mode as described in <a href="#">View Advanced Setup options</a>.</p>
<b>Power-On-Self-Test Automatic Recovery</b>	<p>Enable or disable the automatic recovery of the computer from no power or no-POST failure by applying mitigation steps.</p> <p>By default, the <b>Power-On-Self-Test Automatic Recovery</b> option is enabled.</p> <p><b>i</b> <b>NOTE:</b> To view this option, enable <b>Advanced Setup</b> mode as described in <a href="#">View Advanced Setup options</a>.</p>

**Table 46. System Setup options—Keyboard menu**

<b>Keyboard</b>	
<b>Fn Lock Options</b>	
Fn Lock Options	<p>Enables or disables the Fn Lock option.</p> <p>By default, the <b>Fn Lock</b> option is enabled.</p>
Lock Mode	<p>By default, the <b>Lock Mode Secondary</b> option is selected. With this option, the F1-F12 keys scan the code for their secondary functions.</p>
<b>Keyboard Illumination</b>	<p>Configures the operating mode of the keyboard illumination feature.</p> <p>By default, the <b>Dim</b> option is selected. The keyboard illumination level is set to 50%.</p>
<b>Keyboard Backlight Timeout on AC</b>	<p>Sets the timeout value for the keyboard backlight when an AC adapter is connected to the computer.</p> <p>By default, the <b>10 seconds</b> option is selected.</p> <p><b>i</b> <b>NOTE:</b> To view this option, enable <b>Advanced Setup</b> mode as described in <a href="#">View Advanced Setup options</a>.</p>
<b>Keyboard Backlight Timeout on Battery</b>	<p>Sets the timeout value for the keyboard backlight when the computer is running only on the battery power. The keyboard backlight timeout value is only effective when the backlight is enabled.</p> <p>By default, the <b>10 seconds</b> option is selected.</p>

**Table 46. System Setup options—Keyboard menu (continued)**

Keyboard	
	<p><b>i</b> <b>NOTE:</b> To view this option, enable <b>Advanced Setup</b> mode as described in <a href="#">View Advanced Setup options</a>.</p>
<b>Device Configuration HotKey Access</b>	<p>Allows you to control whether you can access device configuration screens through hotkeys during system startup.</p> <p>By default, the <b>Device Configuration HotKey Access</b> option is enabled.</p> <p><b>i</b> <b>NOTE:</b> This setting controls only the Intel RAID (CTRL+I), MEBX (CTRL+P), and LSI RAID (CTRL+C) Option ROMs. Other preboot Option ROMs, which support entry using a key sequence, are not affected by this setting.</p> <p><b>i</b> <b>NOTE:</b> To view this option, enable <b>Advanced Setup</b> mode as described in <a href="#">View Advanced Setup options</a>.</p>

**Table 47. System Setup options—Pre-boot Behavior menu**

Pre-boot Behavior	
<b>Adapter Warnings</b>	
Enable Adapter Warnings	<p>Enables the warning messages during boot when the adapters with less power capacity are detected.</p> <p>By default, the <b>Enable Adapter Warnings</b> option is enabled.</p> <p><b>i</b> <b>NOTE:</b> To view this option, enable <b>Advanced Setup</b> mode as described in <a href="#">View Advanced Setup options</a>.</p>
<b>Warnings and Errors</b>	<p>Enables or disables the action to be taken when a warning or error is encountered.</p> <p>By default, the <b>Prompt on Warnings and Errors</b> option is selected.</p> <p><b>i</b> <b>NOTE:</b> Errors deemed critical to the operation of the computer hardware stop the functioning of the computer.</p> <p><b>i</b> <b>NOTE:</b> To view this option, enable <b>Advanced Setup</b> mode as described in <a href="#">View Advanced Setup options</a>.</p>
<b>Extend BIOS POST Time</b>	<p>Sets the BIOS POST (Power-On Self-Test) load time.</p> <p>By default, the <b>0 seconds</b> option is selected.</p> <p><b>i</b> <b>NOTE:</b> To view this option, enable <b>Advanced Setup</b> mode as described in <a href="#">View Advanced Setup options</a>.</p>
<b>MAC Address Pass-Through</b>	<p>Replaces the external NIC MAC address (in a supported dock or dongle) with the selected MAC address from the computer.</p> <p>By default, the <b>System Unique MAC Address</b> option is selected.</p>
<b>Sign of Life</b>	
Early Keyboard Backlight	<p>Enables or disables the Keyboard Backlight Sign of Life.</p> <p>By default, the <b>Early Keyboard Backlight</b> option is enabled.</p> <p><b>i</b> <b>NOTE:</b> To view this option, enable <b>Advanced Setup</b> mode as described in <a href="#">View Advanced Setup options</a>.</p>


**Table 48. System Setup options—Virtualization menu**

<b>Virtualization Support</b>
<b>Intel Trusted Execution Technology (TXT)</b>




**Table 48. System Setup options—Virtualization menu (continued)**

<b>Virtualization Support</b>	
Enable Intel Trusted Execution Technology (TXT)	<p>Specifies whether a measured Virtual Machine Monitor (MVMM) can use the additional hardware capabilities provided by Intel Trusted Execution Technology. The following must be enabled in order to enable Intel TXT -</p> <ul style="list-style-type: none"> <li>● Trusted Platform Module (TPM)</li> <li>● Intel Hyper-Threading</li> <li>● All CPU cores (Multi-Core Support)</li> <li>● Intel Virtualization Technology</li> <li>● Intel VT for Direct I/O</li> </ul> <p>By default, the <b>Enable Intel Trusted Execution Technology (TXT)</b> option is disabled.</p> <p><b>NOTE:</b> To view this option, enable <b>Advanced Setup</b> mode as described in <a href="#">View Advanced Setup options</a>.</p>
<b>DMA Protection</b>	
Enable Pre-Boot DMA Support	<p>Allows you to control the Pre-Boot DMA protection for both internal and external ports. This option does not directly enable DMA protection in the operating system.</p> <p><b>NOTE:</b> This option is not available when the virtualization setting for IOMMU is disabled (VT-d/AMD Vi).</p> <p>By default, the <b>Enable Pre-Boot DMA Support</b> option is enabled.</p> <p>For additional security, Dell Technologies recommends keeping the <b>Enable Pre-Boot DMA Support</b> option enabled.</p> <p><b>NOTE:</b> This option is provided only for compatibility purposes, since some older hardware is not DMA capable.</p> <p><b>NOTE:</b> To view this option, enable <b>Advanced Setup</b> mode as described in <a href="#">View Advanced Setup options</a>.</p>
Enable OS Kernel DMA Support	<p>Allows you to control the Kernel DMA protection for both internal and external ports. This option does not directly enable DMA protection in the operating system. For operating systems that support DMA protection, this setting indicates to the operating system that the BIOS supports the feature.</p> <p><b>NOTE:</b> This option is not available when the virtualization setting for IOMMU is disabled (VT-d/AMD Vi).</p> <p>By default, the <b>Enable OS Kernel DMA Support</b> option is enabled.</p> <p><b>NOTE:</b> This option is provided only for compatibility purposes, since some older hardware is not DMA capable.</p> <p><b>NOTE:</b> To view this option, enable <b>Advanced Setup</b> mode as described in <a href="#">View Advanced Setup options</a>.</p>
Internal Port DMA Compatibility Mode	<p>When enabled, BIOS will notify the operating system if the internal ports are not DMA capable.</p> <p><b>NOTE:</b> This option is not available when the virtualization setting for IOMMU is disabled (VT-d/AMD Vi).</p> <p>By default, the <b>Internal Port DMA Compatibility Mode</b> option is disabled.</p> <p><b>NOTE:</b> This option is provided only for compatibility purposes, since some older hardware is not DMA capable.</p> <p><b>NOTE:</b> To view this option, enable <b>Advanced Setup</b> mode as described in <a href="#">View Advanced Setup options</a>.</p>

**Table 49. System Setup options—Performance menu**

Performance	
<b>Intel SpeedStep</b>	
Enable Intel SpeedStep Technology	<p>Enables the computer to dynamically adjust processor voltage and core frequency, decreasing average power consumption and heat production.</p> <p>By default, the <b>Enable Intel SpeedStep Technology</b> option is enabled.</p> <p> <b>NOTE:</b> To view this option, enable <b>Service</b> options as described in <a href="#">View Service options</a>.</p>


**Table 50. System Setup options—System Logs menu**

System Logs	
<b>BIOS Event Log</b>	
Clear BIOS Event Log	<p>Select the option to keep or clear BIOS events logs.</p> <p>By default, the <b>Keep Log</b> option is selected.</p> <p> <b>NOTE:</b> To view this option, enable <b>Advanced Setup</b> mode as described in <a href="#">View Advanced Setup options</a>.</p>
<b>Thermal Event Log</b>	
Clear Thermal Event Log	<p>Select the option to keep or clear thermal events logs.</p> <p>By default, the <b>Keep Log</b> option is selected.</p> <p> <b>NOTE:</b> To view this option, enable <b>Advanced Setup</b> mode as described in <a href="#">View Advanced Setup options</a>.</p>
<b>Power Event Log</b>	
Clear Power Event Log	<p>Select the option to keep or clear power events logs.</p> <p>By default, the <b>Keep Log</b> option is selected.</p> <p> <b>NOTE:</b> To view this option, enable <b>Advanced Setup</b> mode as described in <a href="#">View Advanced Setup options</a>.</p>

## Updating the BIOS


### Updating the BIOS in Windows

#### About this task

 **CAUTION:** If BitLocker is not suspended before updating the BIOS, the BitLocker key is not recognized the next time you reboot the computer. You will then be prompted to enter the recovery key to proceed, and the computer displays a prompt for the recovery key on each reboot. Failure to provide the recovery key can result in data loss or an operating system reinstall. For more information, see the Knowledge Base Resource [updating the BIOS on Dell systems with BitLocker enabled](#).

#### Steps

1. Go to [Dell Support Site](#).
2. Go to **Identify your product or search support**. In the box, enter the product identifier, model, service request or describe what you are looking for, and then click **Search**.

 **NOTE:** If you do not have the Service Tag, use the SupportAssist to automatically identify your computer. You can also use the product ID or manually browse for your computer model.



3. Click **Drivers & Downloads**. Expand **Find drivers**.
4. Select the operating system installed on your computer.
5. In the **Category** drop-down list, select **BIOS**.
6. Select the latest version of BIOS, and click **Download** to download the BIOS file for your computer.
7. After the download is complete, browse the folder where you saved the BIOS update file.
8. Double-click the BIOS update file icon and follow the on-screen instructions.


For more information, search in the Knowledge Base Resource at [Dell Support Site](#).

## Updating the BIOS in Linux and Ubuntu


To update the system BIOS on a computer that is installed with Linux or Ubuntu, see the knowledge base article [000131486](#) at [Dell Support Site](#).

## Updating the BIOS using the USB drive in Windows

### About this task

 **CAUTION:** If BitLocker is not suspended before updating the BIOS, the BitLocker key is not recognized the next time you reboot the computer. You will then be prompted to enter the recovery key to proceed, and the computer displays a prompt for the recovery key on each reboot. Failure to provide the recovery key can result in data loss or an operating system reinstall. For more information, see the Knowledge Base Resource [updating the BIOS on Dell systems with BitLocker enabled](#).

### Steps

1. Go to [Dell Support Site](#).
2. Go to **Identify your product or search support**. In the box, enter the product identifier, model, service request or describe what you are looking for, and then click **Search**.  
 **NOTE:** If you do not have the Service Tag, use the SupportAssist to automatically identify your computer. You can also use the product ID or manually browse for your computer model.
3. Click **Drivers & Downloads**. Expand **Find drivers**.
4. Select the operating system installed on your computer.
5. In the **Category** drop-down list, select **BIOS**.
6. Select the latest version of BIOS, and click **Download** to download the BIOS file for your computer.
7. Create a bootable USB drive. For more information, search in the Knowledge Base Resource at [Dell Support Site](#).
8. Copy the BIOS setup program file to the bootable USB drive.
9. Connect the bootable USB drive to the computer that needs the BIOS update.
10. Restart the computer and press **F12**.
11. Select the USB drive from the **One Time Boot Menu**.
12. Type the BIOS setup program filename and press **Enter**.  
The **BIOS Update Utility** appears.
13. Follow the on-screen instructions to complete the BIOS update.

## Updating the BIOS from the One-Time boot menu

You can run the BIOS flash update file from Windows using a bootable USB drive or you can also update the BIOS from the One-Time boot menu on the computer. To update your computers BIOS, copy the BIOS XXXX.exe file onto a USB drive

formatted with the FAT32 file system. Then, restart your computer and boot from the USB drive using the One-Time Boot Menu.

### About this task

**CAUTION:** If BitLocker is not suspended before updating the BIOS, the next time you reboot the computer it will not recognize the BitLocker key. You will then be prompted to enter the recovery key to progress, and the computer will ask for this on each reboot. If the recovery key is not known this can result in data loss or an unnecessary operating system reinstall. For more information about this subject, search in the Knowledge Base Resource at [Dell Support Site](#).

### BIOS Update

To confirm if the BIOS Flash Update is listed as a boot option, you can boot your computer to the **One Time Boot** Menu. If the option is listed, then the BIOS can be updated using this method.

To update your BIOS from the One-Time boot menu, you need the following:

- USB drive formatted to the FAT32 file system (the drive does not have to be bootable)
- BIOS executable file that you downloaded from the Dell Support website and copied to the root of the USB drive
- AC power adapter must be connected to the computer
- A functional computer battery to flash the BIOS

Perform the following steps to update the BIOS from the One-Time boot menu:

**CAUTION:** Do not turn off the computer during the BIOS flash update process. The computer may not boot if you turn off your computer.

### Steps

1. Turn off the computer, insert the USB drive that contains the BIOS flash update file.
2. Turn on the computer and press **F12** to access the **One Time Boot** Menu. Select **BIOS Update** using the mouse or arrow keys then press Enter.  
The flash BIOS menu is displayed.
3. Click **Flash from file**.
4. Select the external USB device.
5. Select the file and double-click the flash target file, and then click **Submit**.
6. Click **Update BIOS**. The computer restarts to flash the BIOS.
7. The computer will restart after the BIOS flash update is completed.

## System and setup password

**CAUTION:** The password features provide a basic level of security for the data on your computer.

**CAUTION:** Ensure that your computer is locked when it is not in use. Anyone can access the data that is stored on your computer, when left unattended.

**Table 51. System and setup password**

Password type	Description
System password	Password that you must enter to boot to your operating system.
Setup password	Password that you must enter to access and change the BIOS settings of your computer.

You can create a system password and a setup password to secure your computer.

**NOTE:** The System and setup password feature is disabled by default.

## Assigning a System Setup password

### Prerequisites

You can assign a new System or Admin Password only when the status is set to **Not Set**. To enter BIOS System Setup, press F2 immediately after a power-on or reboot.

### Steps


1. In the **System BIOS** or **System Setup** screen, select **Security** and press Enter.  
The **Security** screen is displayed.
2. Select **System/Admin Password** and create a password in the **Enter the new password** field.  
Use the following guidelines to create the system password:
  - Password can be up to 32 characters.
  - Password must contain at least one special character: "( ! " # \$ % & ' \* + , - . / : ; < = > ? @ [ \ ] ^ \_ ` { | } )"
  - The password can contain numbers from 0 to 9.
  - The password can contain alphabets A to Z and a to z.
3. Type the system password that you entered earlier in the **Confirm new password** field and click **OK**.
4. Press Y to save the changes.  
The computer restarts.

## Deleting or changing an existing system password or setup password

### Prerequisites

Ensure that the **Password Status** is Unlocked in the System Setup before attempting to delete or change the existing system password and/or setup password. You cannot delete or change an existing system password or setup password if the **Password Status** is Locked. To enter the System Setup, press F2 immediately after a power-on or reboot.


### Steps

1. In the **System BIOS** or **System Setup** screen, select **System Security** and press Enter.  
The **System Security** screen is displayed.
2. In the **System Security** screen, verify that the **Password Status** is Unlocked.
3. Select **System Password**. Update or delete the existing system password, and press Enter or Tab.
4. Select **Setup Password**. Update or delete the existing setup password, and press Enter or Tab.  
 **NOTE:** If you change the system password and/or setup password, reenter the new password when prompted. If you delete the system password and/or setup password, confirm the deletion when prompted.
5. Press Esc. A message prompts you to save the changes.
6. Press Y to save the changes and exit from **System Setup**.  
The computer restarts.

## Clearing system and setup passwords

### About this task

To clear the system or setup passwords, contact Dell technical support as described at [Contact Support](#).

-  **NOTE:** For information about how to reset Windows or application passwords, see the documentation accompanying Windows or your application.

# Troubleshooting

## Handling swollen rechargeable Li-ion batteries

Like most laptops, Dell laptops use Lithium-ion batteries. One type of Lithium-ion battery is the rechargeable Li-ion battery. Rechargeable Li-ion batteries have increased in popularity in recent years and have become a standard in the electronics industry due to customer preferences for a slim form factor (especially with newer ultra-thin laptops) and long battery life. Inherent to rechargeable Li-ion battery technology is the potential for swelling of the battery cells.

A swollen battery may impact the performance of the laptop. To prevent possible further damage to the device enclosure or internal components leading to malfunction, discontinue the use of the laptop and discharge it by disconnecting the AC adapter and letting the battery drain.

Swollen batteries should not be used and must be replaced and disposed of properly. We recommend contacting Dell Support for options to replace a swollen battery under the terms of the applicable warranty or service contract, including options for replacement by a Dell authorized service technician.

The guidelines for handling and replacing rechargeable Li-ion batteries are as follows:

- Exercise caution when handling rechargeable Li-ion batteries.
- Discharge the battery before removing it from the laptop. To discharge the battery, unplug the AC adapter from the computer and operate the computer only on battery power. The battery is fully discharged when the computer no longer turns on when the power button is pressed.
- Do not crush, drop, mutilate, or penetrate the battery with foreign objects.
- Do not expose the battery to high temperatures, or disassemble battery packs and cells.
- Do not apply pressure to the surface of the battery.
- Do not bend the battery.
- Do not use tools of any type to pry on or against the battery.
- If a battery gets stuck in a device as a result of swelling, do not try to free it as puncturing, bending, or crushing a battery can be dangerous.
- Do not attempt to reassemble a damaged or swollen battery into a laptop.
- Swollen batteries that are covered under warranty should be returned to Dell in an approved shipping container (provided by Dell)—this is to comply with transportation regulations. Swollen batteries that are not covered under warranty should be disposed of at an approved recycling center. Contact Dell Support at [Dell Support Site](#) for assistance and further instructions.
- Using a non-Dell or incompatible battery may increase the risk of fire or explosion. Replace the battery only with a compatible battery purchased from Dell that is designed to work with your Dell computer. Do not use a battery from other computers with your computer. Always purchase genuine batteries from [Dell Site](#) or otherwise directly from Dell.

Rechargeable Li-ion batteries can swell for various reasons such as age, number of charge cycles, or exposure to high heat. For more information about how to improve the performance and lifespan of the laptop battery and to minimize the possibility of occurrence of the issue, search Dell laptop battery in the Knowledge Base Resource at [Dell Support Site](#).

## Dell SupportAssist Pre-boot System Performance Check diagnostics

### About this task

SupportAssist diagnostics (also known as system diagnostics) performs a complete check of your hardware. The Dell SupportAssist Pre-boot System Performance Check diagnostics is embedded within the BIOS and launched by the BIOS internally. The embedded system diagnostics provides options for particular devices or device groups allowing you to:

- Run tests automatically or in an interactive mode.
- Repeat the tests.
- Display or save test results.
- Run thorough tests to add more options and obtain details about any failed devices.

- View status messages that inform you when the tests are completed successfully.
- View error messages that inform you of problems encountered during testing.

**NOTE:** Some tests for specific devices require user interaction. Always ensure that you are present at the computer when the diagnostic tests are performed.

For more information, see the knowledge base article [000181163](#).

## Running the SupportAssist Pre-Boot System Performance Check

### Steps

1. Turn on your computer.
2. As the computer boots, press the F12 key.
3. On the boot menu screen, select **Diagnostics**.  
The diagnostic quick test begins.  
**NOTE:** For more information about running the SupportAssist Pre-Boot System Performance Check on a specific device, see [Dell Support Site](#).
4. If there are any issues, error codes are displayed.  
Note the error code and validation number and contact Dell.

## Built-in self-test (BIST)

### (Motherboard Built-In Self-Test) M-BIST

M-BIST is the system board built-in self-test diagnostics tool that improves the diagnostics accuracy of system board Embedded Controller (EC) failures.

**NOTE:** M-BIST can be manually initiated before Power On Self-Test (POST).

### How to run M-BIST

**NOTE:** Before initiating M-BIST, ensure that the computer is in a power-off state.

1. Press and hold both the **M** key and the power button to initiate M-BIST.
2. The battery indicator LED may exhibit two states:
  - Off: No fault was detected.
  - Amber and White: Indicates a problem with the system board.
3. If there is a failure with the system board, the battery status LED flashes one of the following error codes for 30 seconds:

**Table 52. LED error codes**


Blinking Pattern		Possible Problem
Amber	White	
2	1	CPU Failure
2	8	LCD Power Rail Failure
1	1	TPM Detection Failure
2	4	Memory/RAM failure

4. If there is no failure with the system board, the LCD cycles through the solid color screens (that are described in the LCD-BIST) for 30 seconds and then turn off.



## Logic Built-in Self-test (L-BIST)

L-BIST is an enhancement to the single LED error code diagnostics and is automatically initiated during POST. L-BIST will check the LCD power rail. If there is no power being supplied to the LCD (that is if the L-BIST circuit fails), the battery status LED flashes either an error code [2,8] or an error code [2,7].

 **NOTE:** If L-BIST fails, LCD-BIST cannot function as no power will be supplied to the LCD.

### How to invoke the L-BIST

1. Turn on your computer.
2. If the computer does not start up normally, look at the battery status LED:
  - If the battery status LED flashes an error code [2,7], the display cable may not be connected properly.
  - If the battery status LED flashes an error code [2,8], there is a failure on the LCD power rail of the system board, hence there is no power that is supplied to the LCD.
3. For cases, when a [2,7] error code is shown, check to see if the display cable is properly connected.
4. For cases when a [2,8] error code is shown, replace the system board.


## LCD Built-in Self-Test (LCD-BIST)

Dell laptops have a built-in diagnostic tool that helps you determine if the screen abnormality you are experiencing is an inherent problem with the LCD (screen) of the Dell laptop or with the video card (GPU) and computer settings.

When you notice screen abnormalities like flickering, distortion, clarity issues, fuzzy or blurry image, horizontal or vertical lines, color fade, it is always a good practice to isolate the LCD (screen) by running the LCD-BIST.

### How to invoke the LCD-BIST

1. Turn off your computer.
2. Disconnect any peripherals that are connected to the computer. Connect only the AC adapter (charger) to the computer.
3. Ensure that the LCD (screen) is clean (no dust particles on the surface of the screen).
4. Press and hold the **D** key and press the power button to enter LCD-BIST mode. Continue to hold the **D** key until the computer boots up.
5. The screen displays solid colors and changes colors on the entire screen to white, black, red, green, and blue twice.
6. Then it displays the colors white, black, and red.
7. Carefully inspect the screen for abnormalities (any lines, fuzzy color, or distortion on the screen).
8. At the end of the last solid color (red), the computer shuts down.

 **NOTE:** Dell SupportAssist Preboot diagnostics upon launch initiates an LCD-BIST first, expecting a user intervention to confirm functionality of the LCD.

## System-diagnostic lights

This section lists the system-diagnostic lights of your Dell Pro Max 14 MC14250.

The following table shows different Service LED blinking patterns and associated problems. The diagnostic light codes consist of a two-digit number, and the digits are separated by a comma. The number stands for a blinking pattern; the first digit shows the number of blinks in amber color, and the second digit shows the number of blinks in white color. The Service LED blinks in the following manner:

- The Service LED blinks the number of times equal to the value of the first digit and turns off with a short pause.
- After that, the Service LED blinks the number of times equal to the value of the second digit.
- The Service LED turns off again with a longer pause.
- After the second pause, the blinking pattern will be repeated.

**Table 53. Diagnostic light codes**

Diagnostic light codes (Amber, White)	Problem description
1, 1	TPM detection failure
1, 2	Unrecoverable SPI Flash failure
1, 5	EC unable to program i-Fuse
1, 6	Generic catch-all for ungraceful EC code flow errors
1, 7	Non-RPMC Flash on Boot Guard fused system
1, 8	Chipset "Catastrophic Error" signal has tripped
2, 1	Processor configuration or processor failure
2, 2	System board: BIOS or Read-Only Memory (ROM) failure
2, 3	No memory or Random-Access Memory (RAM) detected
2, 4	Memory or Random-Access Memory (RAM) failure
2, 5	Invalid memory installed
2, 6	System board/chipset error
2, 7	Display failure SBIOS message
2, 8	Display power-rail failure on the system board
3, 1	CMOS battery failure
3, 2	PCI of Video card/chip failure
3, 3	Recovery image not found
3, 4	Recovery image found but invalid
3, 5	EC power-rail error
3, 6	Flash corruption detected by SBIOS
3, 7	Timeout waiting on ME to reply to HECI message
4, 1	Memory DIMM power rail failure
4, 2	Processor power cable connection issue
4, 3	Display panel failure (potentially cracked panel)
4, 4	Power rail failure at system board side
4, 5	Display panel failure and power rail failure at system board side
4, 6	Display cable failure


## Recovering the operating system

When your computer is unable to boot to the operating system even after repeated attempts, it automatically starts Dell SupportAssist OS Recovery.

Dell SupportAssist OS Recovery is a stand-alone tool that is preinstalled in Dell computers running the Windows operating system. It consists of tools to diagnose and troubleshoot issues that may occur before your computer boots to the operating system. It enables you to diagnose hardware issues, repair your computer, back up your files, and restore your computer to its factory state.

You can also download it from the Dell Support website to troubleshoot and fix your computer when it fails to boot into the primary operating system due to software or hardware failures.

For more information about the Dell SupportAssist OS Recovery, see *Dell SupportAssist OS Recovery User's Guide* at [Serviceability Tools at the Dell Support Site](#). Click **SupportAssist** and then click **SupportAssist OS Recovery**.

 **NOTE:** Windows 11 IoT Enterprise LTSC 2024 and Dell ThinOS 10 do not support Dell SupportAssist. For more information about recovering ThinOS 10, see [Recovery mode using R-Key](#).

## Real-Time Clock (RTC Reset)

The Real-Time Clock (RTC) reset function enables you or the service technician to recover Dell computers from No POST/No Power/No Boot situations.

Start the RTC reset with the computer powered off and connected to AC power. Press and hold the power button for twenty-five seconds. The computer RTC Reset occurs after you release the power button.

## Backup media and recovery options

It is recommended to create a recovery drive to troubleshoot and fix problems that may occur with Windows. Dell provides multiple options for recovering the Windows operating system on your Dell computer. For more information, see [Dell Windows Backup Media and Recovery Options](#).

## Network power cycle

### About this task

If your computer is unable to access the Internet due to network connectivity issues, reset your network devices by performing the following steps:

### Steps

1. Turn off the computer.
2. Turn off the modem.

 **NOTE:** Some Internet service providers (ISPs) provide a modem and router combo device.

3. Turn off the wireless router.
4. Wait for 30 seconds.
5. Turn on the wireless router.
6. Turn on the modem.
7. Turn on the computer.

## Drain flea power (perform hard reset)

### About this task

Flea power is the residual static electricity that remains in the computer even after it has been powered off and the battery is removed.

For your safety, and to protect the sensitive electronic components in your computer, you must drain residual flea power before removing or replacing any components in your computer.

Draining flea power, also known as a performing a "hard reset," is also a common troubleshooting step if your computer does not turn on or boot into the operating system.


Perform the following steps to drain the flea power:

### Steps

1. Turn off the computer.
2. Disconnect the power adapter from the computer.
3. Remove the base cover.
4. Remove the battery.

 **CAUTION:** The battery is a Field Replaceable Unit (FRU) and the removal and installation procedures are intended for authorized service technicians only.

5. Press and hold the power button for 20 seconds to drain the flea power.
6. Install the battery.
7. Install the base cover.
8. Connect the power adapter to the computer.
9. Turn on the computer.


 **NOTE:** For more information about performing a hard reset, go to [Dell Support Site](#). On the menu bar at the top of the Support page, select Support > Support Library. In the Search field on the Support Library page, type the keyword, topic, or model number, and then click or tap the search icon to view the related articles.

# Getting help and contacting Dell

## Self-help resources


You can get information and help on Dell products and services using these self-help resources:


**Table 54. Self-help resources**

Self-help resources	Resource location
Information about Dell products and services	<a href="#">Dell Site</a>
Tips	
Contact Support	In Windows search, type <code>Contact Support</code> , and press Enter.
Online help for operating system	<a href="#">Windows Support Site</a> <a href="#">Linux Support Site</a>
Access top solutions, diagnostics, drivers and downloads, and learn more about your computer through videos, manuals, and documents.	Your Dell computer is uniquely identified using a Service Tag or Express Service Code. To view relevant support resources for your Dell computer, enter the Service Tag or Express Service Code at <a href="#">Dell Support Site</a> .  For more information about how to find the Service Tag for your computer, see <a href="#">Locate the Service Tag on your computer</a> .
Dell knowledge base articles	<ol style="list-style-type: none"> <li>1. Go to <a href="#">Dell Support Site</a>.</li> <li>2. On the menu bar at the top of the Support page, select <b>Support &gt; Support Library</b>.</li> <li>3. In the Search field on the Support Library page, type the keyword, topic, or model number, and then click or tap the search icon to view the related articles.</li> </ol>

## Contacting Dell

To contact Dell for sales, technical support, or customer service issues, see [Dell Support Site](#).

 **NOTE:** Availability of the services may vary depending on the country or region, and product.

 **NOTE:** If you do not have an active Internet connection, you can find contact information about your purchase invoice, packing slip, bill, or Dell product catalog.