

# Dell Pro Max Slim

## FCS1250

### Owner's Manual

## Notes, cautions, and warnings

 **NOTE:** A NOTE indicates important information that helps you make better use of your product.

 **CAUTION:** A CAUTION indicates either potential damage to hardware or loss of data and tells you how to avoid the problem.

 **WARNING:** A WARNING indicates a potential for property damage, personal injury, or death.



<b>Chapter 1: Views of Dell Pro Max Slim FCS1250</b> .....	<b>7</b>
Front.....	7
Back.....	8
<b>Chapter 2: Set up your computer</b> .....	<b>11</b>
<b>Chapter 3: Specifications of Dell Pro Max Slim FCS1250</b> .....	<b>16</b>
Dimensions and weight.....	16
Processor.....	16
Chipset.....	18
Operating system.....	19
Memory.....	19
Memory matrix.....	20
External ports and slots.....	20
External Port (optional module slot).....	21
Internal slots.....	21
Wireless module.....	22
Ethernet.....	22
Audio.....	23
Storage.....	23
Storage matrix.....	23
Media-card reader.....	24
Redundant Array of Independent Disks (RAID).....	24
Power ratings.....	24
Power supply connector.....	25
GPU—Integrated.....	25
GPU—Discrete.....	26
Video port resolution.....	26
Hardware security.....	26
Environmental.....	27
Regulatory compliance.....	27
Operating and storage environment.....	27
Dell support policy.....	28
<b>Chapter 4: Working inside your computer</b> .....	<b>29</b>
Safety instructions.....	29
Before working inside your computer.....	29
Safety precautions.....	30
Electrostatic discharge—ESD protection.....	30
ESD Field Service kit .....	31
Transporting sensitive components.....	32
After working inside your computer.....	32
BitLocker.....	32
Recommended tools.....	32

Screw list.....	33
Major components of Dell Pro Max Slim FCS1250.....	34
<b>Chapter 5: Side cover.....</b>	<b>36</b>
Removing the side cover.....	36
Installing the side cover.....	37
<b>Chapter 6: Coin-cell battery.....</b>	<b>40</b>
Removing the coin-cell battery.....	40
Installing the coin-cell battery.....	40
<b>Chapter 7: Removing and installing Customer Replaceable Units (CRUs).....</b>	<b>42</b>
Front cover .....	42
Removing the front cover.....	42
Installing the front cover.....	43
Optical drive.....	44
Removing the optical drive.....	44
Installing the optical drive.....	46
Drive bay.....	48
Removing the drive bay.....	48
Installing the drive bay.....	50
Internal speaker.....	51
Removing the internal speaker.....	51
Installing the internal speaker.....	52
Memory.....	53
Removing the memory module.....	53
Installing the memory module.....	54
Hard drive.....	55
Removing the hard drive.....	55
Installing the hard drive.....	56
Solid state drive.....	58
Removing the M.2 2230 solid state drive from slot 0.....	58
Installing the M.2 2230 solid state drive in slot 0.....	58
Removing the M.2 2230 solid state drive from slot 1.....	60
Installing the M.2 2230 solid state drive in slot 1.....	60
Removing the M.2 2280 solid state drive from slot 2.....	61
Installing the M.2 2280 solid state drive in slot 2.....	62
Removing the M.2 2280 solid state drive from slot 0.....	63
Installing the M.2 2280 solid state drive in slot 0.....	64
Graphics card.....	66
Removing the graphics card.....	66
Installing the graphics card.....	66
Wireless card.....	67
Removing the wireless card.....	67
Installing the wireless card.....	68
Intrusion switch.....	70
Removing the intrusion switch.....	70
Installing the Intrusion switch.....	70
Power button.....	71

Removing the power button.....	71
Installing the power button.....	72
Fan.....	74
Removing the chassis fan.....	74
Installing the chassis fan.....	74
<b>Chapter 8: Removing and installing Field Replaceable Units (FRUs).....</b>	<b>76</b>
Antenna modules.....	76
Removing the antenna module.....	76
Installing the antenna module.....	77
Processor fan and heat-sink assembly.....	79
Removing the processor fan.....	79
Installing the processor fan.....	80
Removing the processor heat-sink assembly.....	81
Installing the processor heat-sink assembly.....	82
Processor.....	84
Removing the processor.....	84
Installing the processor.....	85
Power-supply unit.....	86
Removing the power-supply unit.....	86
Installing the power-supply unit.....	87
External port (optional module).....	90
Removing the optional VGA module.....	90
Installing the optional VGA module.....	91
Removing the optional USB module.....	92
Installing the optional USB module.....	93
Removing the optional Thunderbolt module.....	95
Installing the optional Thunderbolt module.....	96
Removing the optional LAN module.....	98
Installing the optional LAN module.....	99
Removing the optional HDMI module.....	101
Installing the optional HDMI module.....	102
Removing the optional DisplayPort module.....	104
Installing the optional DisplayPort module.....	105
Removing the optional 5 GbE Optical module.....	107
Installing the optional 5 GbE Optical module.....	108
System board.....	111
Removing the system board.....	111
Installing the system board.....	115
<b>Chapter 9: Software.....</b>	<b>121</b>
Operating system.....	121
Drivers and downloads.....	121
<b>Chapter 10: BIOS Setup.....</b>	<b>122</b>
Entering BIOS Setup program.....	122
Navigation keys.....	122
One time boot menu.....	122
F12 One Time Boot menu.....	123

System setup options.....	123
Updating the BIOS.....	127
Updating the BIOS in Windows.....	127
Updating the BIOS in Linux and Ubuntu.....	128
Updating the BIOS using the USB drive in Windows.....	128
Updating the BIOS from the One-Time boot menu.....	129
System and setup password.....	129
Assigning a System Setup password.....	130
Deleting or changing an existing system password or setup password.....	130
Clearing CMOS settings.....	131
Clearing system and setup passwords.....	131
<b>Chapter 11: Troubleshooting.....</b>	<b>132</b>
Dell SupportAssist Pre-boot System Performance Check diagnostics.....	132
Running the SupportAssist Pre-Boot System Performance Check.....	132
Power-Supply Unit Built-in Self-Test .....	132
System-diagnostic lights.....	132
Recovering the operating system.....	133
Real-Time Clock—RTC reset.....	134
Backup media and recovery options.....	134
Network power cycle.....	134
<b>Chapter 12: Getting help and contacting Dell.....</b>	<b>135</b>

# Views of Dell Pro Max Slim FCS1250

## Front

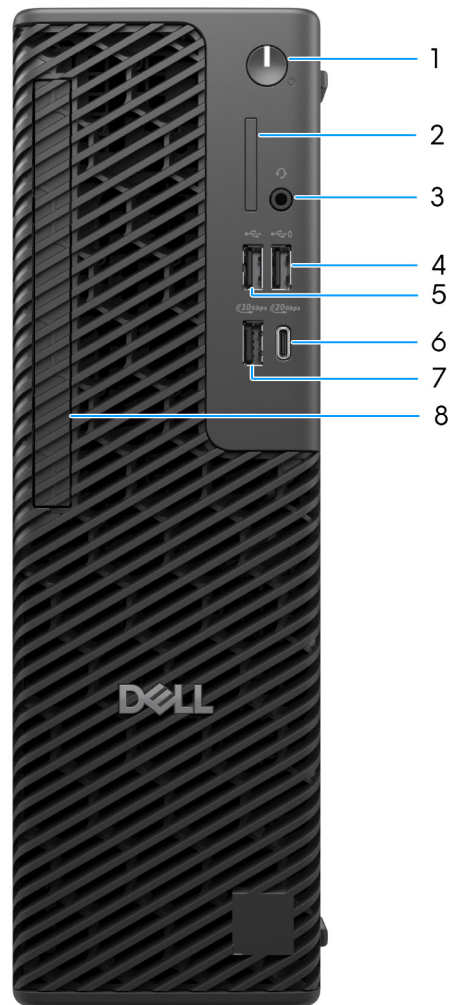

Figure 1. Front view of Dell Pro Max Slim FCS1250

**1. Power button with diagnostic LED**

Press to turn on the computer if it is turned off, in sleep state, or in hibernate state.

**2. SD-card 4.0 slot (optional)**

Reads from and writes to the SD card.

**3. Global headset jack**

Connect headphones or a headset (headphone and microphone combo).

**4. USB 2.0 (480 Mbps) port with PowerShare**

Connect devices such as external storage devices and printers. Provides data transfer speeds up to 480 Mbps.

PowerShare enables you to charge connected USB devices.

**NOTE:** Connected USB devices will not charge when the computer is turned off or in a sleep state. To start charging connected devices, turn on the computer.

**5. USB 2.0 (480 Mbps) port**

Connect devices such as external storage devices and printers. Provides data transfer speeds up to 480 Mbps.

**6. USB 3.2 Gen 2x2 (20 Gbps) Type-C port**

Connect devices such as external storage devices, printers, and external displays. Provides data transfer rate of up to 20 Gbps.

**7. USB 3.2 Gen 2 (10 Gbps) port**

Connect devices such as external storage devices and printers. Provides data transfer speeds up to 10 Gbps.

**8. Slim optical-drive bay (optional)**

Slot to install the Slim optical drive.

## Back

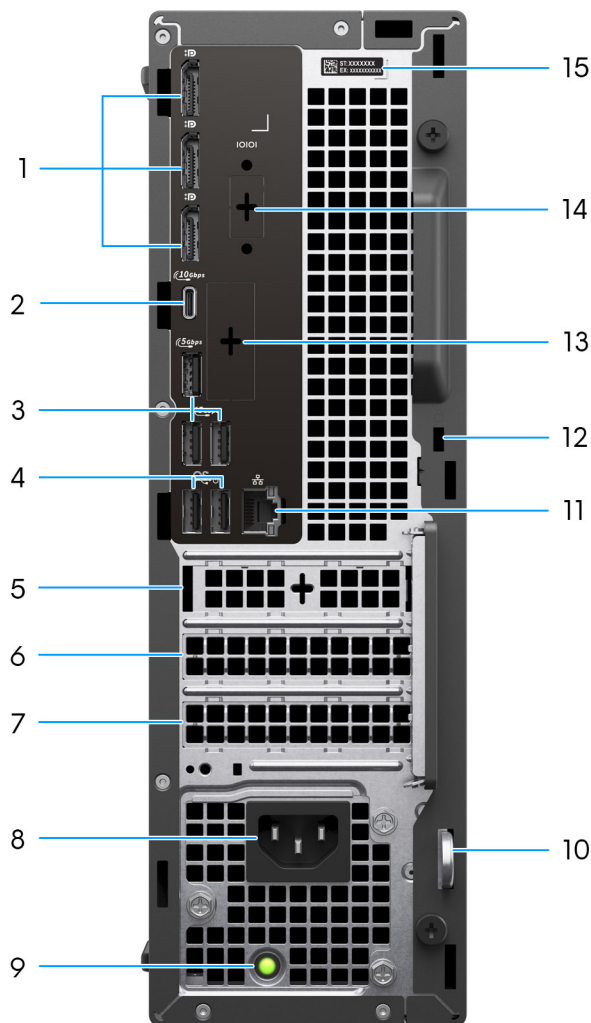

**Figure 2. Back view of Dell Pro Max Slim FCS1250**

**1. DisplayPort 1.4a HBR3 ports**

Connect an external display or a projector.

## 2. **USB 3.2 Gen 2 (10 Gbps) Type-C port**

Connect devices such as external storage devices and printers. Provides data transfer speeds up to 10 Gbps.

## 3. **USB 3.2 Gen 1 (5 Gbps) ports**

Connect devices such as external storage devices and printers. Provides data transfer speeds up to 5 Gbps.

## 4. **USB 2.0 (480 Mbps) ports with SmartPower On**

Connect devices such as external storage devices and printers. Provides data transfer speeds up to 480 Mbps.

## 5. **Half-height Gen3 PCIe x1 slot 1**

Connect a PCI-Express card such as graphics, audio, or network card to enhance the capabilities of your computer.

## 6. **Half-height Gen4 PCIe x16 slot 2**

Connect a PCI-Express card such as graphics, audio, or network card to enhance the capabilities of your computer.

## 7. **Half-height Gen3 PCIe x4 slot 3**

Connect a PCI-Express card such as graphics, audio, or network card to enhance the capabilities of your computer.

## 8. **Power-cord connector**

Connect a power cable to provide power to your computer.

## 9. **Power-supply diagnostics light**

Indicates the power-supply state.

## 10. **Padlock ring**

Attach a standard padlock to prevent unauthorized access to the interior of your computer.

## 11. **RJ45 ethernet port (1 Gbps)**

Connect an Ethernet (RJ45) cable from a router or a broadband modem for network or Internet access, with a transfer rate of 10/100/1000 Mbps.

## 12. **Security-cable slot (for Kensington lock)**

Connect a security cable to prevent unauthorized movement of your computer.

## 13. **Optional port**

The port or ports available at this location may vary depending on the optional-port module that is installed on your computer.

 **NOTE:** Only one of these options can be installed at the location that is shown on your computer.

- **VGA port**

Connect an external display or a projector. The maximum resolution that is supported by this port is up to 1920 x 1200 at 60 Hz.

- **HDMI 2.1 (FRL) port**

Connect to a TV, external display, or another HDMI-in enabled device. The maximum resolution that is supported by this port is up to 5120 x 3200 at 60 Hz.

- **DisplayPort 2.1 (UHBR20) port**

Connect an external display or a projector. The maximum resolution that is supported by this port is up to 7680 x 4320 at 60 Hz.

- **Dual USB 3.2 Gen 2 (10 Gbps) ports**

Connect devices such as external storage devices and printers. Provides data transfer speeds of up to 10 Gbps.

- **USB 3.2 Gen 2 (10 Gbps) Type-C with DisplayPort port**

Connect devices such as external storage devices and printers. Provides data transfer speeds of up to 10 Gbps. The maximum resolution that is supported by this port is up to 5120 x 3200 at 60 Hz with a Type-C to DisplayPort adapter.

- **One Thunderbolt 4 port + One USB 3.2 Gen 2 (10 Gbps) Type-C**

Connect devices such as external storage devices and printers. Provides data transfer speeds of up to 10 Gbps.

- **RJ45 ethernet port (5 Gbps)**

Connect an RJ45 Ethernet cable from a router or a broadband modem for network or Internet access.

- **LC fiber optic cable (5 Gbps)**

Connect an LC fiber optic cable from a router or a broadband modem for network or Internet access.

 **NOTE:** Supports up to 5 Gbps connectivity on peer-to-peer transmission. Actual speed on the network depends on equipment compatibility, requiring both transceiver and switch at the same maximum speed.

#### **14. Legacy serial port (optional)**

Connect a peripheral or device to the RS-232 serial port.

#### **15. Service Tag label**

The Service Tag is a unique alphanumeric identifier that enables Dell service technicians to identify the hardware components in your computer and access warranty information.



## Set up your computer

### Steps

1. Connect the keyboard and mouse.

**NOTE:** For setup instructions, see the documentation that is shipped with the keyboard and mouse.

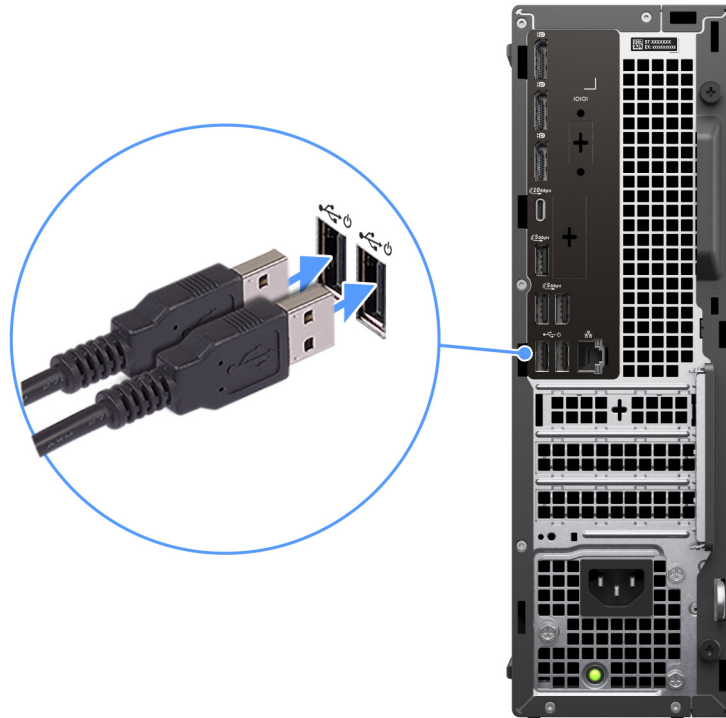

**Figure 3. Connecting the keyboard and mouse**

2. Connect to your network using a cable, or connect to a wireless network.

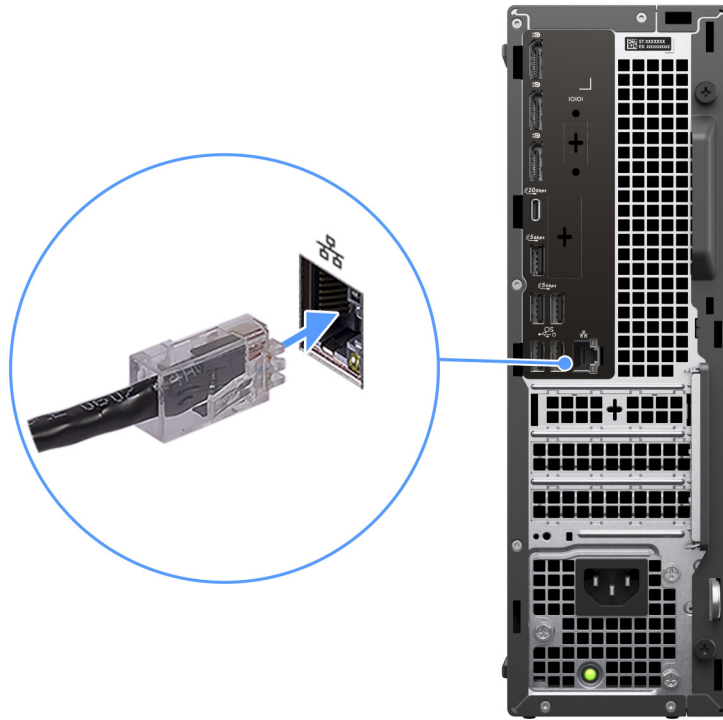

**Figure 4. Connecting the network cable**

3. Connect the display.

**i** **NOTE:** For improved graphical performance, connect the display to the display ports on the discrete graphics processing unit.



**Figure 5. Connecting the display**

4. Connect the power cable.

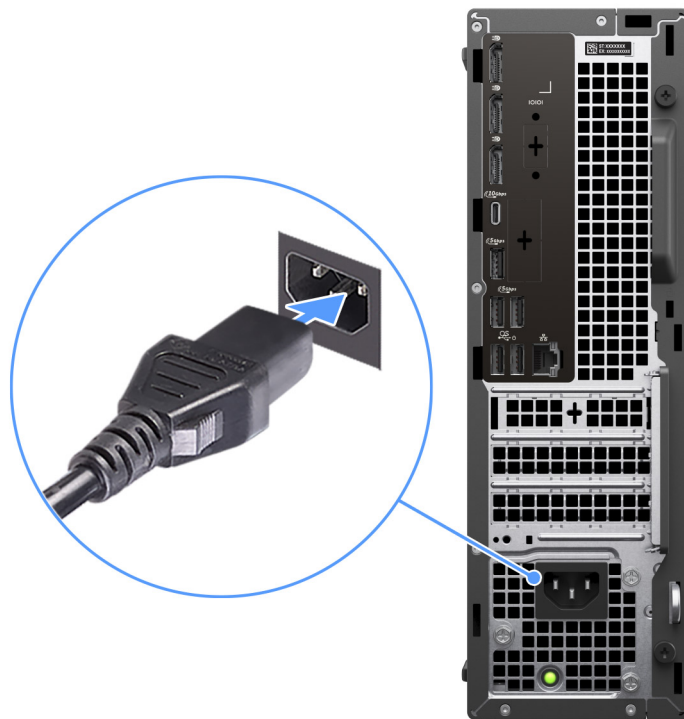

**Figure 6. Connecting the power cable**

5. Press the power button.



**Figure 7. Pressing the power button**

6. Finish the operating system setup.

**For Ubuntu:**

Follow the on-screen instructions to complete the setup. For more information about installing and configuring Ubuntu, search in the Knowledge Base Resource at [Dell Support Site](#).

**For Windows:**

Follow the on-screen instructions to complete the setup. When setting up, Dell Technologies recommends that you:



- Connect to a network for Windows updates.

**NOTE:** If connecting to a secured wireless network, enter the password for the wireless network access when prompted.

- If connected to the Internet, sign-in with or create a Microsoft account. If not connected to the Internet, create an offline account.
- On the **Support and Protection** screen, enter your contact details.

7. Locate and use Dell apps from the Windows Start menu—Recommended.

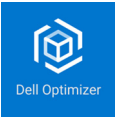
**Table 1. Locate Dell apps**

Resources	Description
	Dell Optimizer is an application is designed to enhance computer performance and productivity by optimizing settings for power, battery, display, collaboration touchpad, and presence detection. It also provides access to applications purchased with your new computer. For more information, see Dell Optimizer User's Guide at <a href="#">Dell Support Site</a> .
	<b>SupportAssist</b> SupportAssist is a proactive and predictive technology that offers automated technical support for Dell computers. It proactively monitors both hardware and software, addressing performance issues, preventing security threats, and automating engagement with Dell Technical Support.

**Table 1. Locate Dell apps (continued)**

Resources	Description
	<p data-bbox="400 275 1246 304">. For more information, see SupportAssist documentation at <a href="#">Dell Support Site</a>.</p> <p data-bbox="400 320 1433 349"><b>NOTE:</b> In SupportAssist, click the warranty expiry date to renew or upgrade your warranty.</p>

# Specifications of Dell Pro Max Slim FCS1250

## Dimensions and weight

The following table lists the height, width, depth, and weight of your Dell Pro Max Slim FCS1250.

**Table 2. Dimensions and weight**

Description	Values
Height	303.50 mm (11.95 in.)
Width	95.00 mm (3.74 in.)
Depth	293.00 mm (11.53 in.)
Weight  <b>NOTE:</b> The weight of your computer depends on the configuration ordered and manufacturing variability.	<ul style="list-style-type: none"> <li>• Minimum: 3.97 kg (8.75 lb)</li> <li>• Maximum: 6.11 kg (13.47 lb)</li> </ul>

## Processor

The following tables list the details of the processors that are supported in your Dell Pro Max Slim FCS1250.

**Table 3. Processor**

Description	Option one	Option two	Option three	Option four
Processor type	Intel Core Ultra 5 235	Intel Core Ultra 5 245	Intel Core Ultra 5 245K	Intel Core Ultra 7 265
Processor wattage	65 W	65 W	125 W	65 W
Processor total core count	14	14	14	20
Performance-cores	6	6	6	8
Efficient-cores	8	8	8	12
Processor total thread count	14	14	14	20
 <b>NOTE:</b> Intel Hyper-Threading Technology is available only on Performance-cores.				
Processor speed	Up to 5 GHz	Up to 5.10 GHz	Up to 5.20 GHz	Up to 5.30 GHz
Frequency—Performance cores				
Processor base frequency	3.40 GHz	3.50 GHz	4.20 GHz	2.40 GHz
Maximum turbo frequency	5 GHz	5.10 GHz	5.20 GHz	5.30 GHz
Frequency—Efficient cores				
Processor base frequency	2.90 GHz	3 GHz	3 GHz	1.80 GHz
Maximum turbo frequency	4.40 GHz	4.50 GHz	4.50 GHz	4.60 GHz
Processor cache	24 MB	24 MB	24 MB	30 MB
Integrated graphics	Intel Graphics	Intel Graphics	Intel Graphics	Intel Graphics

**Table 4. Processor**

Description	Option five	Option six	Option seven
Processor type	Intel Core Ultra 7 265K	Intel Core Ultra 9 285	Intel Core Ultra 9 285K
Processor wattage	125 W	65 W	125 W
Processor total core count	20	24	24
Performance-cores	8	8	8
Efficient-cores	12	16	16
Processor total thread count	20	24	24
 <b>NOTE:</b> Intel Hyper-Threading Technology is only available on Performance-cores.			
Processor speed	Up to 5.50 GHz	Up to 5.60 GHz	Up to 5.70 GHz
Frequency—Performance cores			
Processor base frequency	3.90 GHz	2.50 GHz	3.70 GHz
Maximum turbo frequency	5.50 GHz	5.60 GHz	5.70 GHz
Frequency—Efficient cores			
Processor base frequency	1.80 GHz	1.90 GHz	2.0 GHz
Maximum turbo frequency	4.60 GHz	4.60 GHz	4.80 GHz
Processor cache	30 MB	36 MB	36 MB
Integrated graphics	Intel Graphics	Intel Graphics	Intel Graphics

## Chipset

The following table lists the details of the chipset that is supported by your Dell Pro Max Slim FCS1250.

**Table 5. Chipset**

Description	Values
Chipset	Intel W880
Processor	Intel Core Ultra 5/7/9
DRAM bus width	64-bit/128-bit
Flash EPROM	32 MB RPMC + 32 MB nRPMC
PCIe bus	Up to Gen4



# Operating system

Your Dell Pro Max Slim FCS1250 supports the following operating systems:

- Windows 11 Home
- Windows 11 Pro
- Windows 11 Pro National Academic
- Windows 11 Enterprise
- Ubuntu Linux 24.04 LTS

For more information about Dell operating system Recovery image, see *How to Download and Use the Dell OS Recovery Image in Microsoft Windows*, at [Dell support site](#).

## Commercial platform Windows 11 N-2 and 5-year operating system supportability:

All newly introduced 2019 and later commercial platforms (Dell, Dell Pro, and Dell Pro Max) will qualify and ship with the most current factory installed Semi-Annual Channel Windows 11 version (N) and qualify (but not ship) the previous two versions (N-1, N-2). The Dell Pro Max Slim FCS1250 will RTS with Windows 11 version v23H2 at the time of launch, and this version will determine the N-2 versions that are initially qualified for this platform.

For future versions of Windows 11, Dell continues to test the commercial platform with coming Windows 11 releases during device production and for five years post-production, including both fall and spring releases from Microsoft.

For additional information about N-2 and 5-year Windows operating system supportability, see the Dell Windows as a Service (WaaS), at [Dell support site](#).

## EOML 411

The Dell Pro Max Slim FCS1250 continues to test the coming Semi-Annual Channel Windows 11 version releases for five years post-production, including both fall and spring releases from Microsoft.

# Memory

The following table lists the memory specifications that are supported by your Dell Pro Max Slim FCS1250.

**Table 6. Memory specifications**

Description	Values
Memory slots	Four UDIMM slots
Memory type	DDR5
Memory speed	<ul style="list-style-type: none"> <li>• 4400 MT/s</li> <li>• 4800 MT/s</li> <li>• 5600 MT/s</li> </ul>
Maximum memory configuration	128 GB
Minimum memory configuration	8 GB
Memory size per slot	8 GB, 16 GB, 32 GB
Memory configurations supported	<ul style="list-style-type: none"> <li>• 8 GB: 1 x 8 GB, DDR5, 5600 MT/s, UDIMM, Non-ECC, single-channel</li> <li>• 16 GB: 2 x 8 GB, DDR5, 5600 MT/s, UDIMM, Non-ECC, dual-channel</li> <li>• 16 GB: 1 x 16 GB, DDR5, 5600 MT/s, UDIMM, Non-ECC, single-channel</li> <li>• 32 GB: 2 x 16 GB, DDR5, 5600 MT/s, UDIMM, Non-ECC, dual-channel</li> <li>• 32 GB: 4 x 8 GB, DDR5, 4800 MT/s, UDIMM, Non-ECC, dual-channel</li> </ul>

**Table 6. Memory specifications (continued)**

Description	Values
	<ul style="list-style-type: none"> <li>64 GB: 2 x 32 GB, DDR5, 5600 MT/s, UDIMM, Non-ECC, dual-channel</li> <li>64 GB: 4 x 16 GB, DDR5, 4800 MT/s, UDIMM, Non-ECC, dual-channel</li> <li>128 GB: 4 x 32 GB, DDR5, 4400 MT/s, UDIMM, Non-ECC, dual-channel</li> <li>16 GB: 1 x 16 GB, DDR5, 5600 MT/s, UDIMM, ECC, single-channel</li> <li>32 GB: 2 x 16 GB, DDR5, 5600 MT/s, UDIMM, ECC, dual-channel</li> <li>64 GB: 2 x 32 GB, DDR5, 5600 MT/s, UDIMM, ECC, dual-channel</li> <li>64 GB: 4 x 16 GB, DDR5, 4800 MT/s, UDIMM, ECC, dual-channel</li> <li>128 GB: 4 x 32 GB, DDR5, 4400 MT/s, UDIMM, ECC, dual-channel</li> </ul>

## Memory matrix

The following table lists the memory configurations supported on your Dell Pro Max Slim FCS1250.

**Table 7. Memory matrix**

Configuration	Slot			
	UDIMM1	UDIMM2	UDIMM3	UDIMM4
8 GB DDR5	8 GB			
16 GB DDR5	8 GB	8 GB		
16 GB DDR5	16 GB			
32 GB DDR5	8 GB	8 GB	8 GB	8 GB
32 GB DDR5	16 GB	16 GB		
32 GB DDR5	32 GB			
64 GB DDR5	16 GB	16 GB	16 GB	16 GB
64 GB DDR5	32 GB	32 GB		
128 GB DDR5	32 GB	32 GB	32 GB	32 GB

## External ports and slots

The following table lists the external ports and slots of your Dell Pro Max Slim FCS1250.

**Table 8. External ports and slots**

Description	Values
Network port	One RJ45 ethernet port (1 Gbps)
USB ports	<ul style="list-style-type: none"> <li>Three USB 3.2 Gen 1 (5 Gbps) ports</li> <li>One USB 3.2 Gen 2 (10 Gbps) port</li> <li>One USB 3.2 Gen 2 (10 Gbps) Type-C port</li> <li>One USB 3.2 Gen 2x2 (20 Gbps) Type-C port</li> </ul>

**Table 8. External ports and slots (continued)**

Description	Values
	<ul style="list-style-type: none"> <li>One USB 2.0 (480 Mbps) port with PowerShare</li> <li>Three USB 2.0 (480 Mbps) ports</li> </ul>
Audio port	One global headset jack
Video port(s)	Three DisplayPort 1.4a HBR3 ports
Media-card reader	One SD-card 4.0 slot (optional)
Power-adapter port	One power-cable connector
Security-cable slot	<ul style="list-style-type: none"> <li>One padlock ring</li> <li>One Kensington security-cable slot</li> </ul>

## External Port (optional module slot)

The following table lists the external ports that are supported on the optional module slot for Dell Pro Max Slim FCS1250.

**i** **NOTE:** The ports that are listed in this table are mutually exclusive. Your Dell Pro Max Slim FCS1250 can only support one of the listed options.

**Table 9. External ports (optional module)**

Description	Values
Network port	<ul style="list-style-type: none"> <li>One RJ45 Ethernet port (5 Gbps)</li> <li>One LC fiber optic cable (5 Gbps)</li> </ul>
USB ports	<ul style="list-style-type: none"> <li>Two USB 3.2 Gen 2 (10 Gbps) ports</li> <li>One USB 3.2 Gen 2 (10 Gbps) Type-C with DisplayPort Alt Mode port</li> <li>One Thunderbolt 4 port + one USB 3.2 Gen 2 (10 Gbps) Type-C Data only</li> </ul>
Video ports	<ul style="list-style-type: none"> <li>One HDMI 2.1 (FRL) port</li> <li>One VGA port</li> <li>One DisplayPort 2.1 (UHBR20) port</li> </ul>

## Internal slots

The following table lists the internal slots on your Dell Pro Max Slim FCS1250.

**Table 10. Internal slots**

Description	Values
M.2	<ul style="list-style-type: none"> <li>One M.2 2230 slot for WiFi and Bluetooth combo card</li> <li>One M.2 2230/2280 slot for solid state drive</li> <li>One M.2 2230/2280 slot for solid state drive (without bracket)</li> <li>One M.2 2230 slot for solid state drive</li> </ul> <p><b>i</b> <b>NOTE:</b> To learn more about the features of different types of M.2 cards, search in the Knowledge Base Resource at <a href="#">Dell Support Site</a>.</p>

**Table 10. Internal slots (continued)**

Description	Values
SATA	<ul style="list-style-type: none"> <li>One SATA 3.0 slot for a 3.5-inch hard drive</li> <li>One SATA 3.0 slot for slimline optical drive</li> </ul>
PCIe	<ul style="list-style-type: none"> <li>One half-height Gen4 PCIe x16 slot</li> <li>One half-height, Gen3 PCIe x4 slot</li> <li>One half-height, Gen3 PCIe x1 slot</li> </ul>

## Wireless module

The following table lists the Wireless Local Area Network (WLAN) modules that are supported on your Dell Pro Max Slim FCS1250.

**Table 11. Wireless module specifications**

Description	Option one	Option two
Model number	Intel Wi-Fi 7 BE200	Qualcomm FastConnect 7800
Transfer rate	Up to 5760 Mbps	Up to 5760 Mbps
Frequency bands supported	2.4 GHz/5 GHz/6 GHz	2.4 GHz/5 GHz/6 GHz
Wireless standards	<ul style="list-style-type: none"> <li>WiFi 802.11a/b/g</li> <li>Wi-Fi 4 (WiFi 802.11n)</li> <li>Wi-Fi 5 (WiFi 802.11ac)</li> <li>Wi-Fi 6E (WiFi 802.11ax)</li> <li>Wi-Fi 7 (WiFi 802.11be)</li> </ul>	<ul style="list-style-type: none"> <li>WiFi 802.11a/b/g</li> <li>Wi-Fi 4 (WiFi 802.11n)</li> <li>Wi-Fi 5 (WiFi 802.11ac)</li> <li>Wi-Fi 6 (WiFi 802.11ax)</li> <li>Wi-Fi 7 (WiFi 802.11be)</li> </ul>
Encryption	<ul style="list-style-type: none"> <li>64-bit/128-bit WEP</li> <li>AES-CCMP</li> <li>TKIP</li> </ul>	<ul style="list-style-type: none"> <li>64-bit/128-bit WEP</li> <li>AES-CCMP</li> <li>TKIP</li> </ul>
Bluetooth wireless card	Bluetooth 5.4 wireless card	Bluetooth 5.4 wireless card
	 <b>NOTE:</b> The functionality of the Bluetooth wireless card may vary depending on the operating system that is installed on your computer.	

## Ethernet

The following table lists the wired ethernet Local Area Network (LAN) specifications of your Dell Pro Max Slim FCS1250.

**Table 12. Ethernet specifications**

Description	Values
Model	Intel i219-LM
Transfer rate	10/100/1000 Mbps

# Audio

The following table lists the audio specifications of your Dell Pro Max Slim FCS1250.

**Table 13. Audio specifications**

Description	Values
Audio type	High Definition Audio
Audio controller	Realtek ALC3204
Internal audio interface	High Definition Audio (HDA) interface
External audio interface	One global headset jack

# Storage

This section lists the storage options on your Dell Pro Max Slim FCS1250.

**Table 14. Storage specifications**

Storage type	Interface type	Capacity
3.5-inch, 7200 RPM, hard drive	SATA AHCI, up to 6 Gbps	2 TB
3.5-inch, 7200 RPM hard drive, SAS, Enterprise hard drive	SATA AHCI, up to 6 Gbps	8 TB
3.5-inch, 7200 RPM, hard drive, SAS, Enterprise hard drive	SATA AHCI, up to 6 Gbps	4 TB
M.2 2230 solid state drive, Class 35	PCIe Gen4 NVMe, up to 64 GT/s	512 GB
M.2 2230 solid-state drive, Class 35	PCIe Gen4 x4 NVMe, up to 64 GT/s	256 GB
M.2 2280 self-encrypting Opal 2.0 solid state drive, Class 40	PCIe Gen4 x4 NVMe, up to 64 GT/s	4 TB
M.2 2280 self-encrypting Opal 2.0 solid-state drive, Class 40	PCIe Gen4 x4 NVMe, up to 64 GT/s	512 GB
M.2 2280 self-encrypting Opal 2.0 solid-state drive, Class 40	PCIe Gen4 x4 NVMe, up to 64 GT/s	1 TB
M.2 2280 self-encrypting Opal 2.0 solid-state drive, Class 40	PCIe Gen4 x4 NVMe, up to 64 GT/s	2 TB
9.5 mm 8x slimline DVD-RW drive	SATA AHCI, up to 1.5 Gbps	One slimline DVD-RW

# Storage matrix

The following table lists the storage configurations supported on your Dell Pro Max Slim FCS1250.

Your Dell Pro Max Slim FCS1250 supports a combination of the following storage configurations:

- One 3.5-inch hard drive
- Up to three M.2 2230 solid state drive
- Up to two M.2 2280 solid state drives

The primary drives of your Dell Pro Max Slim FCS1250 varies with the storage configuration. For computers:

- With a M.2 drive, the M.2 drive is the primary drive.
- Without a M.2 drive, the 3.5-inch hard drive is the primary drive.

## Media-card reader

The following table provides the specification of media cards that are supported by your Dell Pro Max Slim FCS1250.

**Table 15. Media-card reader specifications**

Description	Values
Media-card slot type	One SD-card 4.0 slot (optional)
Media-cards supported	<ul style="list-style-type: none"> <li>• Secure Digital (SD)</li> <li>• Secure Digital High Capacity (SDHC)</li> <li>• Secure Digital Extended Capacity (SDXC)</li> </ul>
<p><b>NOTE:</b> The maximum capacity that is supported by the media-card reader varies depending on the standard of the media card that is installed on your computer.</p>	

## Redundant Array of Independent Disks (RAID)

For optimal performance when configuring drives as a RAID volume, Dell Technologies recommends using identical drive models.

**NOTE:** RAID is not supported on Intel Optane configurations.

RAID 0 (Striped, Performance) volumes benefit from higher performance when drives are matched because the data is split across multiple drives: However, any I/O operations with block sizes larger than the stripe size will be constrained by the slowest drive in the array. For RAID 0 I/O operations where block sizes are smaller than the stripe size, whichever drive the I/O operation targets, determines the performance, which increases variability and results in inconsistent latencies. This variability is particularly pronounced for write operations, and it can be problematic for applications that are latency sensitive. One such example of this is any application that performs thousands of random writes per second in very small block sizes.

RAID 1 (Mirrored, Data Protection) volumes benefit from higher performance when drives are matched because the data is mirrored across multiple drives all I/O operations must be performed identically to both drives, thus variations in drive performance when the models are different result in the I/O operations completing only as fast as the slowest drive. While this does not suffer from the variable latency issue in small random I/O operations as with RAID 0 across heterogeneous drives, the impact is nonetheless large because the higher performing drive becomes limited in all I/O types. One of the worst examples of constrained performance here is when using unbuffered I/O. To ensure that that writes are fully committed to nonvolatile regions of the RAID volume, unbuffered I/O bypasses cache (for example by using the Force Unit Access bit in the NVMe protocol) and the I/O operation will not complete until all the drives in the RAID volume have completed the request to commit the data. This kind of I/O operation completely negates any advantage of a higher performing drive in the volume.

Care must be taken to match not only the drive vendor, capacity, and class, but also the specific model. Drives from the same vendor, with the same capacity, and even within the same class, can have different performance characteristics for certain types of I/O operations. Thus, matching by model ensures that the RAID volume consists of a homogeneous array of drives that deliver all the benefits of a RAID volume without incurring the additional penalties when one or more drives in the volume are lower performing.

Dell Pro Max Slim FCS1250 supports RAID with more than one hard drive configuration.

## Power ratings

The following table lists the power rating specifications of Dell Pro Max Slim FCS1250.

**Table 16. Power ratings**

Description	Option one	Option two
Type	260 W, Bronze	360 W, Platinum

**Table 16. Power ratings (continued)**

Description	Option one	Option two
Input voltage	90 VAC–264 VAC	90 VAC–264 VAC
Input frequency	47 Hz–63 Hz	47 Hz–63 Hz
Input current (maximum)	4.20 A	5 A
Output current (continuous)	Operating: <ul style="list-style-type: none"> <li>● 12 VA: 18 A</li> <li>● 12 VB: 16 A</li> </ul> Storage: <ul style="list-style-type: none"> <li>● 12 VA: 1.50 A</li> <li>● 12 VB: 3.30 A</li> </ul>	Operating: <ul style="list-style-type: none"> <li>● 12 VA: 18 A</li> <li>● 12 VB: 18 A</li> <li>● 12 VC: 13 A</li> </ul> Storage: <ul style="list-style-type: none"> <li>● 12 VA: 1.50 A</li> <li>● 12 VB: 3.30 A</li> <li>● 12 VC: 0 A</li> </ul>
Rated output voltage	<ul style="list-style-type: none"> <li>● 12 VA</li> <li>● 12 VB</li> </ul>	<ul style="list-style-type: none"> <li>● 12 VA</li> <li>● 12 VB</li> <li>● 12 VC</li> </ul>
Temperature range:		
Operating	5°C to 45°C (41°F to 113°F)	5°C to 45°C (41°F to 113°F)
Storage	-40°C to 70°C (-40°F to 158°F)	-40°C to 70°C (-40°F to 158°F)

## Power supply connector

The following table lists the Power supply connector specifications of your Dell Pro Max Slim FCS1250.

**Table 17. Power supply connector**

Power supply	Connectors
260 W internal power supply unit (PSU), 80 Plus Bronze	<ul style="list-style-type: none"> <li>● Two 4-pin connectors for the processor</li> <li>● One 6-pin connector for the system board</li> </ul>
360 W internal power supply unit (PSU), 80 Plus Platinum	<ul style="list-style-type: none"> <li>● Two 4-pin connectors for the processor</li> <li>● One 6-pin connector for the system board</li> </ul>

## GPU—Integrated

The following table lists the specifications of the integrated Graphics Processing Unit (GPU) supported by your Dell Pro Max Slim FCS1250.

**Table 18. GPU—Integrated**

Controller	Memory size	Processor
Intel Graphics	Shared system memory	Intel Core Ultra 5/7/9

## GPU—Discrete

The following table lists the specifications of the discrete graphics processing unit (GPU) supported by your Dell Pro Max Slim FCS1250.

**Table 19. GPU—Discrete**

Controller	Memory size	Memory type
NVIDIA RTX A400	4 GB	GDDR6
NVIDIA RTX A1000	8 GB	GDDR6
NVIDIA RTX 2000 Ada	16 GB	GDDR6
NVIDIA RTX 4000 SFF Ada	20 GB	GDDR6

## Video port resolution

The following table lists the video port resolution for your Dell Pro Max Slim FCS1250.

**Table 20. Video port resolution**

Graphics card	Video ports	Maximum supported resolution
NVIDIA RTX A400	<ul style="list-style-type: none"> <li>Four mini DisplayPort 1.4a</li> </ul>	<ul style="list-style-type: none"> <li>4096 x 2160 @ 120 Hz</li> <li>5120 x 2880 @ 60 Hz</li> </ul>
NVIDIA RTX A1000	<ul style="list-style-type: none"> <li>Four mini DisplayPort 1.4a</li> </ul>	<ul style="list-style-type: none"> <li>4096 x 2160 @ 120 Hz</li> <li>5120 x 2880 @ 60 Hz</li> <li>7680 x 4320 @ 30 Hz</li> </ul>
NVIDIA RTX 2000 Ada-next	<ul style="list-style-type: none"> <li>Four mini DisplayPort 1.4a</li> </ul>	<ul style="list-style-type: none"> <li>4096 x 2160 @ 120 Hz</li> <li>5120 x 2880 @ 60 Hz</li> <li>7680 x 4320 @ 60 Hz</li> </ul>
NVIDIA RTX 4000 SFF Ada-next	<ul style="list-style-type: none"> <li>Four DisplayPort 1.4a</li> </ul>	<ul style="list-style-type: none"> <li>4096 x 2160 @ 120 Hz</li> <li>5120 x 2880 @ 60 Hz</li> <li>7680 x 4320 @ 60 Hz</li> </ul>

## Hardware security

The following table lists the hardware security of your Dell Pro Max Slim FCS1250.

**Table 21. Hardware security**

Hardware security
Chassis intrusion switch
Chassis lock slot support
Intel Authenticate
Intel Secure Boot
Security-cable slot (Kensington lock)
Local hard drive data wipe through BIOS (Secure Erase)
Microsoft 10 Device Guard and Credential Guard (Enterprise SKU)



**Table 21. Hardware security (continued)**

Hardware security
Microsoft Windows BitLocker
Padlock ring
SafeBIOS: includes Dell Off-host BIOS Verification, BIOS Resilience, BIOS Recovery, and additional BIOS Controls
SafelD including Trusted Platform Module (TPM) 2.0
Self-encrypting storage drives (Opal, FIPS)
Smart card keyboard (FIPS)
Supply chain tamper alerts
Trusted Platform Module TPM 2.0

## Environmental

The following table lists the environmental specifications of your Dell Pro Max Slim FCS1250.

**Table 22. Environmental**

Feature	Values
Recyclable packaging	Yes
BFR/PVC—free chassis	Yes
Vertical orientation packaging support	No
Multi-Pack packaging	Yes
Energy-Efficient Power Supply	Standard
ENV0424 compliant	Yes

**i** **NOTE:** Wood-based fiber packaging contains a minimum of 35% recycled content by total weight of wood-based fiber. Packaging that contains without wood-based fiber can be claimed as Not Applicable. The anticipated required criteria for EPEAT 2018.

## Regulatory compliance

The following table lists the regulatory compliance of your Dell Pro Max Slim FCS1250.

**Table 23. Regulatory compliance**

Regulatory compliance
<a href="#">Product Safety, EMC and Environmental Datasheets</a>
<a href="#">Dell Regulatory Compliance Home page</a>
<a href="#">Responsible Business Alliance policy</a>

## Operating and storage environment

This table lists the operating and storage specifications of your Dell Pro Max Slim FCS1250.

**Airborne contaminant level:** G1 as defined by ISA-S71.04-1985

**Table 24. Computer environment**

<b>Description</b>	<b>Operating</b>	<b>Storage</b>
Temperature range	0°C to 35°C (32°F to 95°F)	-40°C to 65°C (-40°F to 149°F)
Relative humidity (maximum)	10% to 90% (non-condensing)	0% to 95% (non-condensing)
Vibration (maximum)*	0.66 GRMS	1.30 GRMS
Shock (maximum)	110 G†	160 G†
Altitude range	-15.2 m to 3048 m (-49.87 ft to 10000 ft)	-15.2 m to 10668 m (-49.87 ft to 35000 ft)
 <b>CAUTION: Operating and storage temperature ranges may differ among components, so operating or storing the device outside these ranges may impact the performance of specific components.</b>		

\* Measured using a random vibration spectrum that simulates the user environment.

† Measured using a 2 ms half-sine pulse.









## Dell support policy

For information about Dell support policy, search in the Knowledge Base Resource at [Dell Support Site](#).

# Working inside your computer

## Safety instructions

Use the following safety guidelines to protect your computer from potential damage and to ensure your personal safety. Unless otherwise noted, each procedure in this document assumes that you have read the safety information that shipped with your computer.



-  **WARNING:** Before working inside your computer, read the safety information that is shipped with your computer. For more safety best practices, see [Dell Regulatory Compliance Home Page](#).
-  **WARNING:** Disconnect your computer from all power sources before opening the computer cover or panels. After you finish working inside the computer, replace all covers, panels, and screws before connecting your computer to an electrical outlet.
-  **CAUTION:** To avoid damaging the computer, ensure that the work surface is flat, dry, and clean.
-  **CAUTION:** You should only perform troubleshooting and repairs as authorized or directed by the Dell technical support team. Damage due to servicing that is not authorized by Dell is not covered by your warranty. See the safety instructions that are shipped with the product or at [Dell Regulatory Compliance Home Page](#).
-  **CAUTION:** Before touching anything inside your computer, ground yourself by touching an unpainted metal surface, such as the metal at the back of the computer. While you work, periodically touch an unpainted metal surface to dissipate static electricity which could harm internal components.
-  **CAUTION:** To avoid damaging the components and cards, handle them by their edges, and avoid touching the pins and the contacts.
-  **CAUTION:** When you disconnect a cable, pull it by its connector or its pull tab, not the cable itself. Some cables have connectors with locking tabs or thumbscrews that you must disengage before disconnecting the cable. When disconnecting cables, keep them evenly aligned to avoid bending the connector pins. When connecting cables, ensure that the connector on the cable is correctly oriented and aligned with the port.
-  **CAUTION:** Press and eject any installed card from the media-card reader.
-  **CAUTION:** Exercise caution when handling rechargeable Li-ion batteries in laptops. Swollen batteries should not be used and should be replaced and disposed properly.

## Before working inside your computer

### About this task

 **NOTE:** The images in this document may differ from your computer depending on the configuration you ordered.

### Steps

1. Save and close all open files and exit all open applications.
2. Shut down your computer. For Windows operating system, click **Start** >  **Power** > **Shut down**.
  -  **NOTE:** If you are using a different operating system, see the documentation of your operating system for shut-down instructions.
3. Turn off all the attached peripherals.
4. Disconnect your computer and all attached devices from their electrical outlet.

5. Disconnect all attached network devices and peripherals, such as keyboard, mouse, and monitor from your computer.

 **CAUTION: To disconnect a network cable, unplug the cable from your computer.**

6. Remove any media card and optical disc from your computer, if applicable.

## Safety precautions

This section details the primary steps to be followed before disassembling any device or component.

Observe the following safety precautions before any installation or break-fix procedures involving disassembly or reassembly:

- Turn off the computer and all attached peripherals.
- Disconnect the computer from AC power.
- Disconnect all network cables and peripherals from the computer.
- Use an ESD field service kit when working inside your computer to avoid electrostatic discharge (ESD) damage.
- Place the removed component on an anti-static mat after removing it from the computer.
- Wear shoes with nonconductive rubber soles to reduce the chance of getting electrocuted.
- Press and hold the power button for 15 seconds to discharge the residual power in the system board.

## Standby power

Dell products with standby power must be unplugged before you open the back cover. Systems that are equipped with standby power are powered while turned off. The internal power enables the computer to be remotely turned on (Wake-on-LAN) and suspended into a sleep mode and has other advanced power management features.

## Bonding

Bonding is a method for connecting two or more grounding conductors to the same electrical potential. This is done by using a field service electrostatic discharge (ESD) kit. When connecting a bonding wire, ensure that it is connected to bare metal and never to a painted or nonmetal surface. Ensure that the wrist strap is secure and in full contact with your skin. Remove all jewelry, watches, bracelets, or rings before grounding yourself and the equipment.

## Electrostatic discharge—ESD protection

ESD is a major concern when you handle electronic components, especially sensitive components such as expansion cards, processors, memory modules, and system boards. A slight charge can damage circuits in ways that may not be obvious, such as intermittent problems or a shortened product life span. As the industry pushes for lower power requirements and increased density, ESD protection is an increasing concern.

Two recognized types of ESD damage are catastrophic and intermittent failures.

- **Catastrophic** – Catastrophic failures represent approximately 20 percent of ESD-related failures. The damage causes an immediate and complete loss of device functionality. An example of catastrophic failure is a memory module that has received a static shock and immediately generates a "No POST/No Video" symptom with a beep code that is emitted for missing or nonfunctional memory.
- **Intermittent** – Intermittent failures represent approximately 80 percent of ESD-related failures. The high rate of intermittent failures means that most of the time when damage occurs, it is not immediately recognizable. The memory module receives a static shock, but the tracing is merely weakened and does not immediately produce outward symptoms that are related to the damage. The weakened trace may take weeks or months to melt, and in the meantime may cause degradation of memory integrity, intermittent memory errors, and so on.

Intermittent failures that are also called latent or "walking wounded" are difficult to detect and troubleshoot.

Perform the following steps to prevent ESD damage:

- Use a wired ESD wrist strap that is properly grounded. Wireless anti-static straps do not provide adequate protection. Touching the chassis before handling parts does not ensure adequate ESD protection on parts with increased sensitivity to ESD damage.
- Handle all static-sensitive components in a static-safe area. If possible, use anti-static floor pads and workbench pads.
- When unpacking a static-sensitive component from its shipping carton, do not remove the component from the anti-static packing material until you are ready to install the component. Before unwrapping the anti-static packaging, use the anti-

static wrist strap to discharge the static electricity from your body. For more information about the wrist strap and ESD wrist strap tester, see [Components of an ESD Field Service Kit](#).

- Before transporting a static-sensitive component, place it in an anti-static container or packaging.

## ESD Field Service kit

The unmonitored field service kit is the most commonly used service kit. Each Field Service kit includes three main components: anti-static mat, wrist strap, and bonding wire.

 **CAUTION: It is critical to keep ESD-sensitive devices away from internal parts that are insulated and often highly charged, such as plastic heat sink casings.**

## Working Environment

Before deploying the ESD Field Service kit, assess the situation at the customer location. For example, deploying the kit for a server environment is different than for a desktop or laptop environment. Servers are typically installed in a rack within a data center; desktops or laptops are typically placed on office desks or cubicles. Always look for a large open flat work area that is free of clutter and large enough to deploy the ESD kit with additional space to accommodate the type of computer that is being repaired. The workspace should also be free of insulators that can cause an ESD event. On the work area, insulators such as styrofoam and other plastics should always be moved at least 12 inches or 30 centimeters away from sensitive parts before physically handling any hardware components.

## ESD Packaging

All ESD-sensitive devices must be shipped and received in static-safe packaging. Metal, static-shielded bags are preferred. However, you should always return the damaged component using the same ESD bag and packaging that the new part arrived in. The ESD bag should be folded over and taped shut and all the same foam packing material should be used in the original box that the new part arrived in. ESD-sensitive devices should be removed from packaging only at an ESD-protected work surface, and parts should never be placed on top of the ESD bag because only the inside of the bag is shielded. Always place parts in your hand, on the anti-static mat, in the computer, or inside an ESD bag.

## Components of an ESD Field Service kit

The components of an ESD Field Service kit are:

- **Anti-Static Mat** – The anti-static mat is dissipative and parts can be placed on it during service procedures. When using an anti-static mat, your wrist strap should be snug and the bonding wire should be connected to the anti-static mat and to any bare metal on the computer being worked on. Once deployed properly, service parts can be removed from the ESD bag and placed directly on the anti-static mat. ESD-sensitive items are safe in your hand, on the anti-static mat, in the computer, or inside an ESD bag.
- **Wrist Strap and Bonding Wire** – The wrist strap and bonding wire can be either directly connected between your wrist and bare metal on the hardware if the anti-static mat is not required, or connect to the anti-static mat to protect hardware that is temporarily placed on the mat. The physical connection of the wrist strap and bonding wire between your skin, the anti-static mat, and the hardware is known as bonding. Use only Field Service kits with a wrist strap, anti-static mat, and bonding wire. Never use wireless wrist straps. Always be cautious that the internal wires of a wrist strap are prone to damage from normal wear and tear, and must be checked regularly with a wrist strap tester in order to avoid accidental ESD hardware damage. It is recommended to test the wrist strap and bonding wire at least once per week.
- **ESD Wrist Strap Tester** – The wires inside an ESD strap are prone to damage over time. When using an unmonitored kit, it is a best practice to regularly test the strap before each service, and at a minimum, test once per week. A wrist strap tester is the best method for doing this test. To perform the test, plug the bonding-wire of the wrist-strap into the tester while it is strapped to your wrist and push the button to test. A green LED is lit if the test is successful; a red LED is lit and an alarm sounds if the test fails.

 **NOTE:** It is recommended to always use the traditional wired ESD grounding wrist strap and protective anti-static mat when servicing Dell products. In addition, it is critical to keep sensitive parts separate from all insulator parts while servicing the computer.

## Transporting sensitive components

When transporting ESD sensitive components such as replacement parts or parts to be returned to Dell, it is critical to place these parts in anti-static bags for safe transport.

## Lifting equipment

Adhere to the following guidelines when lifting heavy equipment:

 **CAUTION: Do not lift greater than 50 pounds. Always obtain additional resources or use a mechanical lifting device.**

1. Get a firm balanced footing. Keep your feet apart for a stable base, and point your toes out.
2. Tighten stomach muscles. Abdominal muscles support your spine when you lift, offsetting the force of the load.
3. Lift with your legs, not your back.
4. Keep the load close. The closer it is to your spine, the less force it exerts on your back.
5. Keep your back upright, whether lifting or setting down the load. Do not add the weight of your body to the load. Avoid twisting your body and back.
6. Follow the same technique in reverse to set the load down.

## After working inside your computer

### About this task

 **CAUTION: Leaving stray or loose screws inside your computer may severely damage your computer.**

### Steps

1. Replace all screws and ensure that no stray screws remain inside your computer.
2. Connect any external devices, peripherals, or cables you removed before working on your computer.
3. Replace any media cards, discs, or any other components that you removed before working on your computer.
4. Connect your computer and all attached devices to their electrical outlets.
5. Turn on your computer.

## BitLocker

 **CAUTION: If BitLocker is not suspended before updating the BIOS, the BitLocker key is not recognized the next time that you reboot the computer. You will be prompted to enter the recovery key to progress, and the computer displays a prompt for the recovery key on each reboot. If the recovery key is not known, this can result in data loss or an operating system reinstall. For more information, see Knowledge Article: [updating the BIOS on Dell computers with BitLocker enabled](#).**

The installation of the following components triggers BitLocker:

- Hard disk drive or solid state drive
- System board

## Recommended tools













The procedures in this document may require the following tools:

- Phillips screwdriver #1
- Plastic scribe

# Screw list

- NOTE:** When removing screws from a component, it is recommended to note the screw type and the quantity of screws, and then place them in a screw storage box. This is to ensure that the correct number of screws and correct screw type is restored when the component is replaced.
- NOTE:** Some computers have magnetic surfaces. Ensure that the screws are not left attached to such surfaces when replacing a component.
- NOTE:** Screw color may vary depending on the configuration ordered.

**Table 25. Screw list**

Component	Screw type	Quantity	Screw image
M.2 2230/2280 solid state drive in slot 0	M2x3.5	1	
M.2 2230 solid state drive in slot 1	M2x3.5	1	
M.2 2230/2280 solid state drive in slot 2	M2x3.5	1	
Wireless card	M2x3.5	1	
Hard drive	#6-32	4	
Optional-port module	M2x4	1	
Legacy Serial-port module (optional)	M3x4	2	
Antenna modules	#6-32	1	
Power-supply unit	#6-32	3	
Processor fan and heat-sink assembly	Captive screw	4	
Front I/O-bracket	#6-32	1	
System board	#6-32	5	
	#6-32, standoff screw	2	



# Major components of Dell Pro Max Slim FCS1250

The following image shows the major components of Dell Pro Max Slim FCS1250.

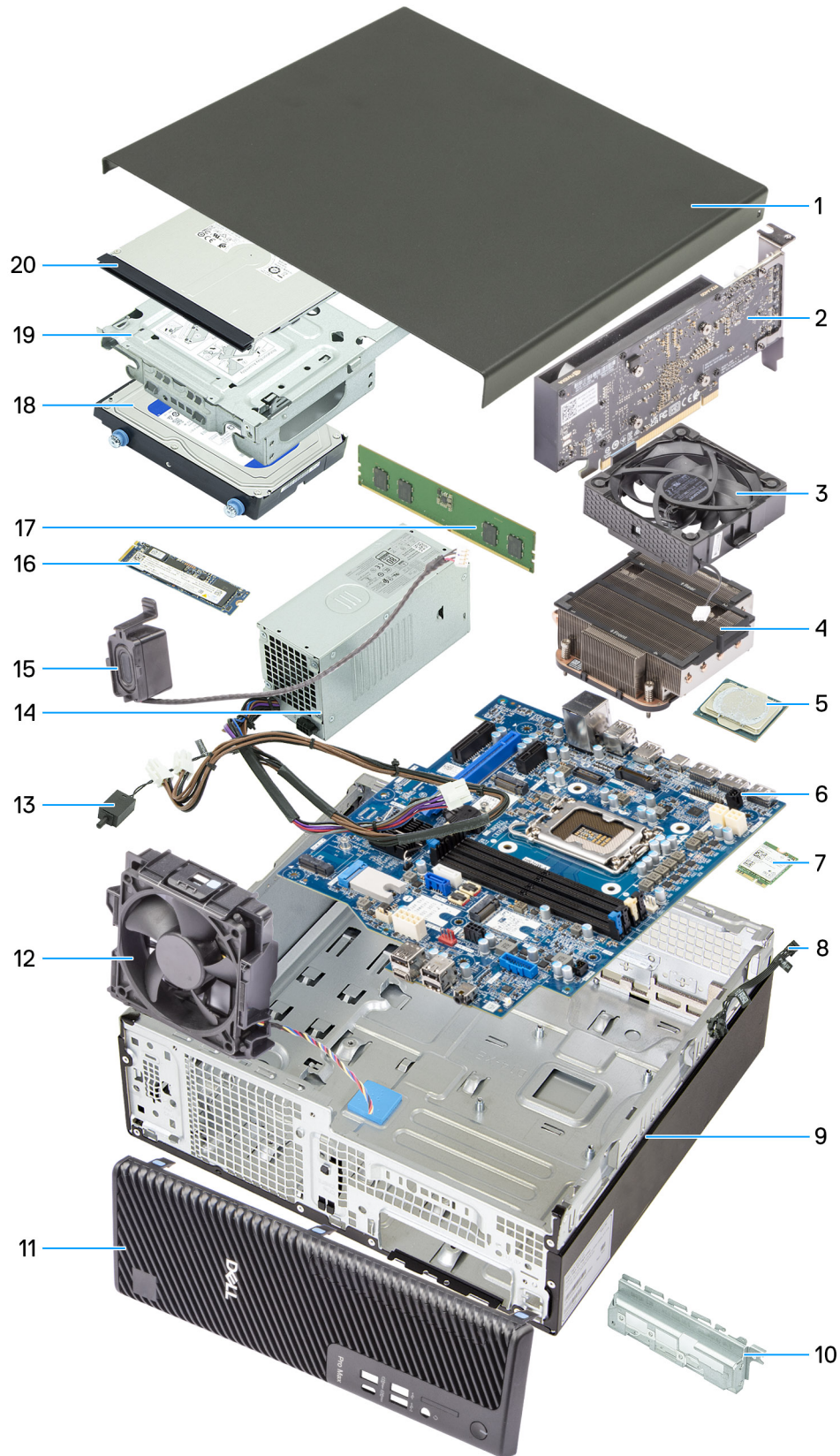



Figure 8. Major Components of Dell Pro Max Slim FCS1250



1. Side cover
2. Graphics card
3. Processor fan
4. Processor fan heat-sink assembly
5. Processor
6. System board
7. Wireless card
8. Power-button module
9. Chassis
10. Front I/O bracket
11. Front cover
12. Chassis fan
13. Intrusion switch
14. Power-supply unit
15. Internal speaker
16. M.2 2280 solid state drive
17. Memory module
18. Hard drive
19. Drive-bay
20. Optical drive

 **NOTE:** Dell Technologies provides a list of components and their part numbers for the original computer configuration purchased. These parts are available according to warranty coverages purchased by the customer. Contact your Dell sales representative for purchase options.

## Side cover

### Removing the side cover

#### Prerequisites

1. Follow the procedure in [Before working inside your computer](#).

#### About this task

The following images indicate the location of the side cover and provide a visual representation of the removal procedure.

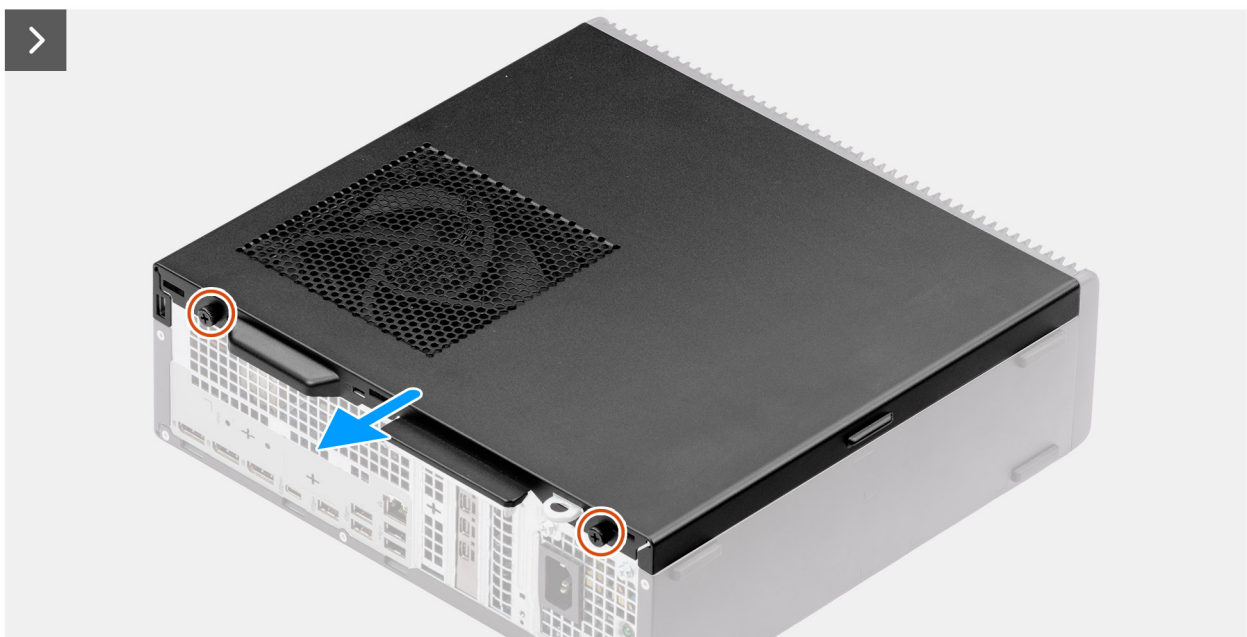
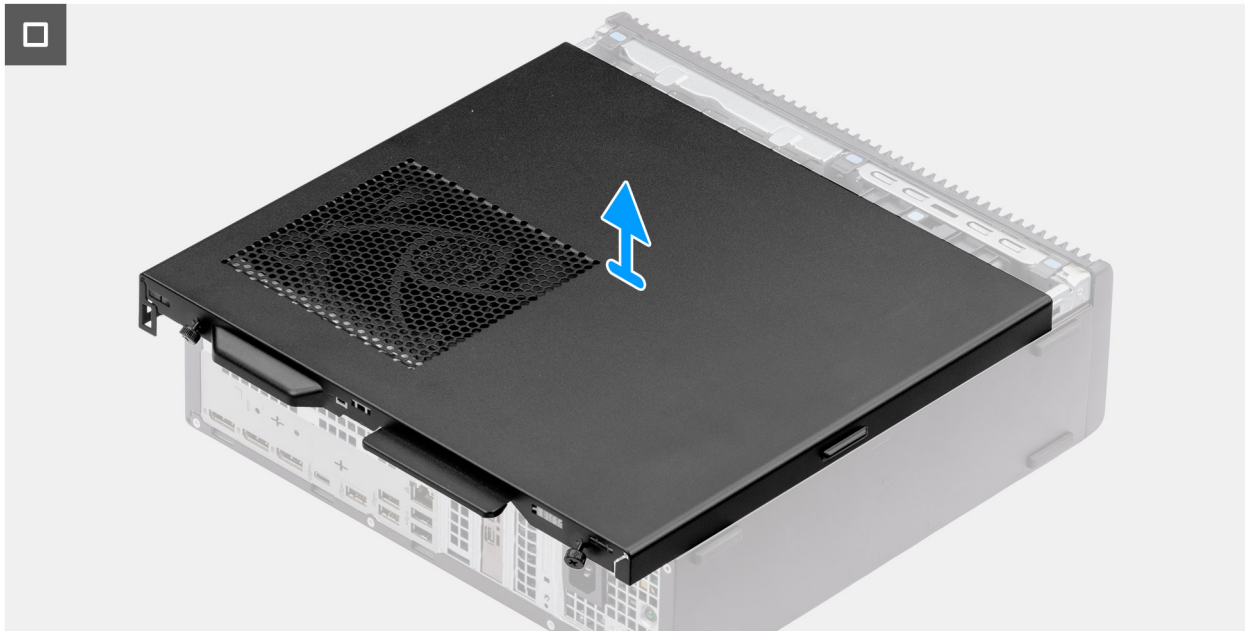

Figure 9. Removing the side cover



**Figure 10. Removing the side cover**

#### **Steps**

1. Place the computer on its side with the side cover facing up.
2. Loosen the two captive screws (6-32#) that secure the side cover to the chassis.
3. Slide the side cover towards the back of the computer.
4. Lift the side cover from the chassis.

## **Installing the side cover**

#### **Prerequisites**

If you are replacing a component, remove the existing component before performing the installation procedure.

#### **About this task**

The following images indicate the location of the side cover and provide a visual representation of the installation procedure.



2x

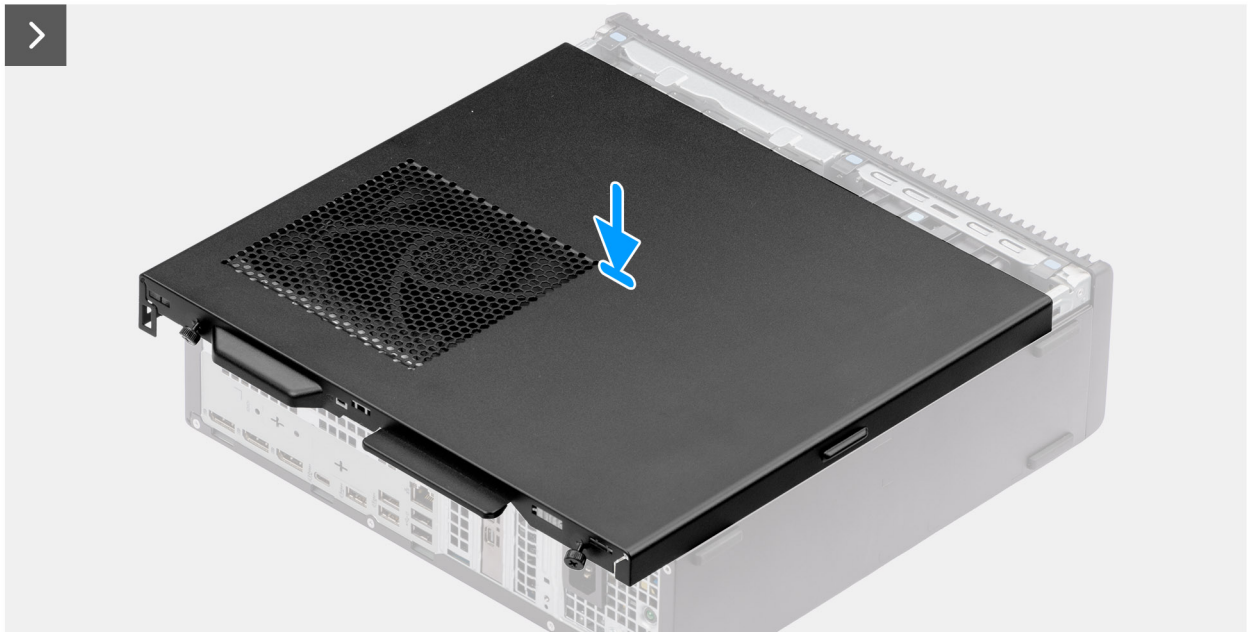

Figure 11. Installing the side cover

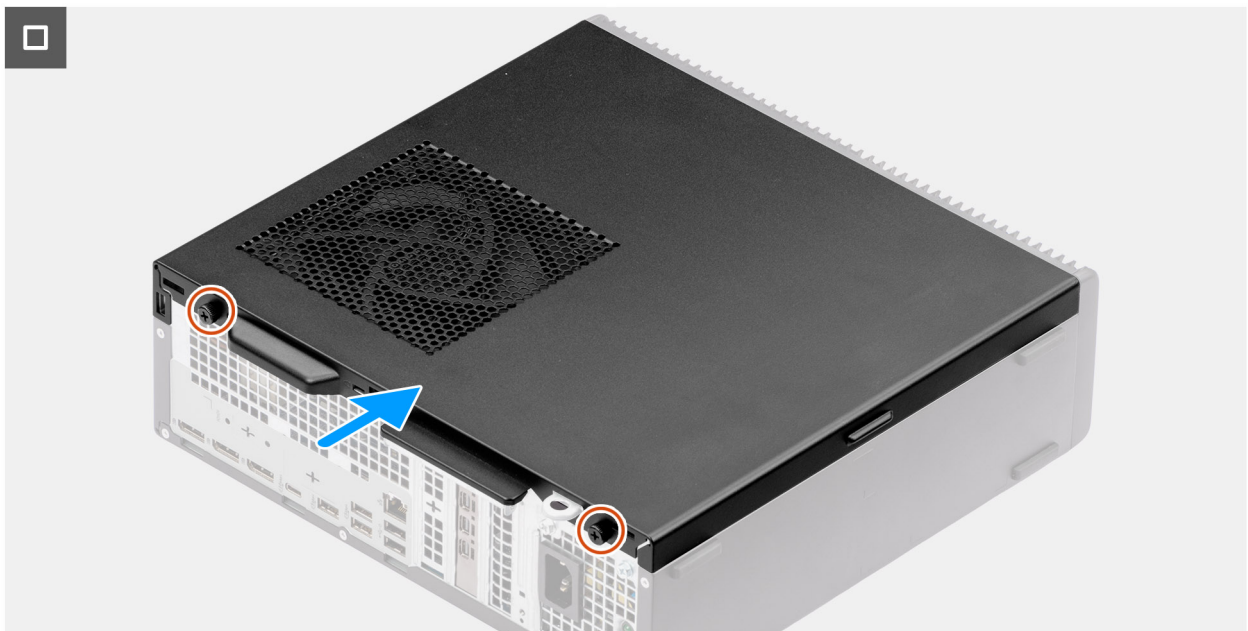

Figure 12. Installing the side cover

#### Steps

1. Align the tabs on the side cover with the slots on the chassis.
2. Slide the side cover towards the front of the computer.
3. Tighten the two captive screws (6-32#) that secure the side cover to the chassis.

**Next steps**

1. Follow the procedure in [After working inside your computer](#).

## Coin-cell battery

### Removing the coin-cell battery

#### Prerequisites

1. Follow the procedure in [before working inside your computer](#).
2. Remove the [side cover](#).

#### About this task

The following image indicates the location of the coin-cell battery cover and provides a visual representation of the removal procedure.

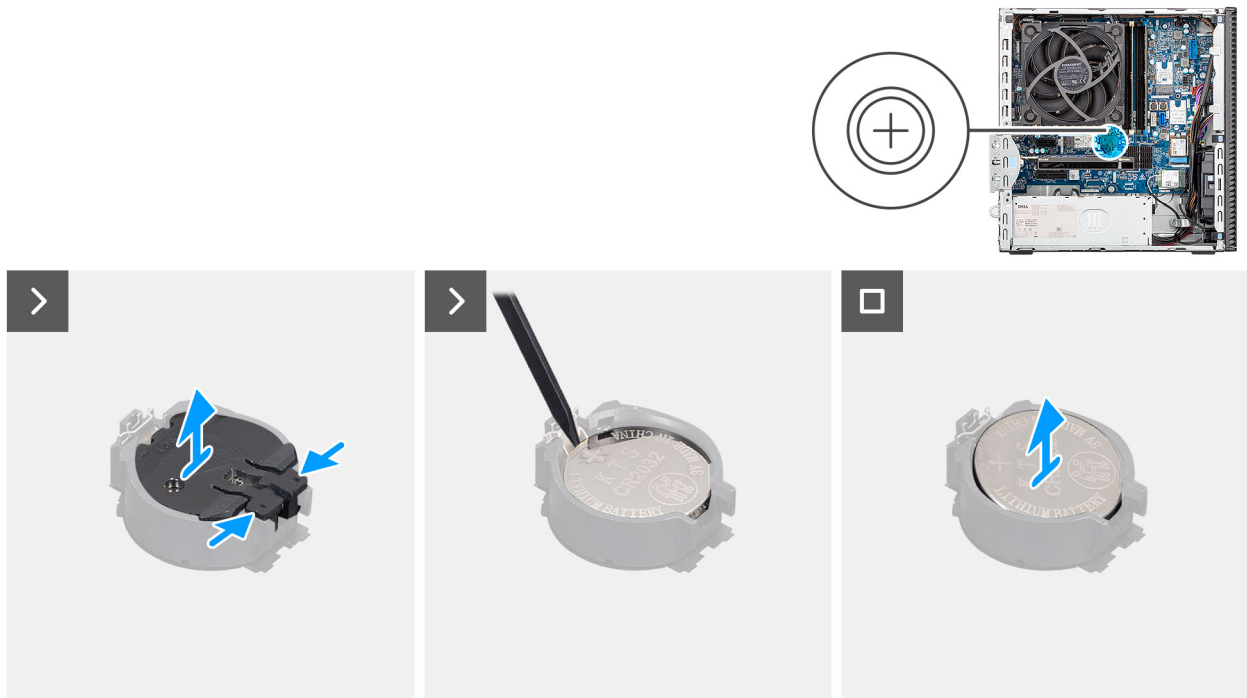

Figure 13. Removing the coin-cell battery

#### Steps

1. Pinch the securing tabs on the coin-cell cover to release the coin-cell cover from the coin-cell battery socket (RTC).
2. Lift the coin-cell cover off the battery socket.
3. Using a plastic scribe, gently pry the coin-cell battery out of the slot on the system board.
4. Remove the coin-cell battery.

### Installing the coin-cell battery

#### Prerequisites

If you are replacing a component, remove the existing component before performing the installation process.

### About this task

The following image indicates the location of the coin-cell battery cover and provides a visual representation of the installation procedure.

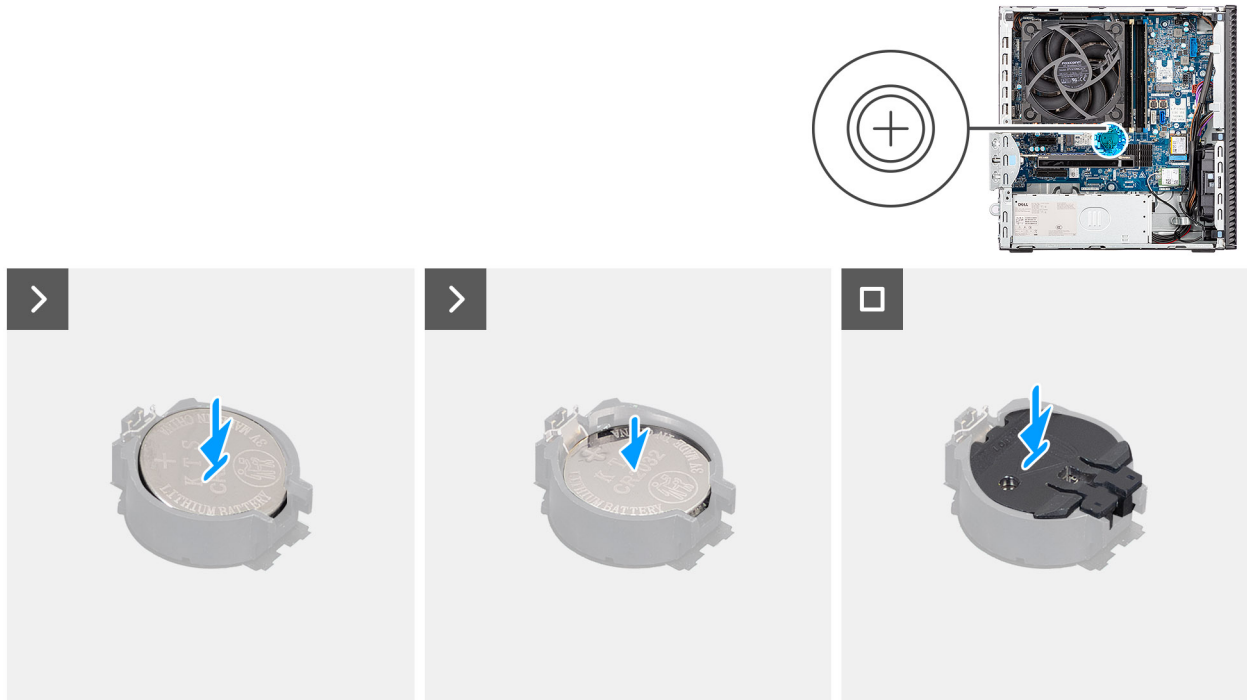

**Figure 14. Installing the coin-cell battery**

### Steps

1. Insert the coin-cell battery with the "+" sign facing up and slide it under the securing tabs at the positive side of the connector.
2. Press the battery into the connector until it locks into place.
3. Align the coin-cell battery cover with the battery socket and press it into place.

### Next steps

1. Install the [side cover](#).
2. Follow the procedure in [after working inside your computer](#).

# Removing and installing Customer Replaceable Units (CRUs)

The replaceable components in this chapter are Customer Replaceable Units (CRUs).

 **CAUTION:** Customers can replace only the Customer Replaceable Units (CRUs) following the safety precautions and replacement procedures.

 **NOTE:** The images in this document may differ from your computer depending on the configuration you ordered.

## Front cover

### Removing the front cover

#### Prerequisites

1. Follow the procedure in [before working inside your computer](#).
2. Remove the [side cover](#).

#### About this task

The following images indicate the location of the front cover and provide a visual representation of the removal procedure.



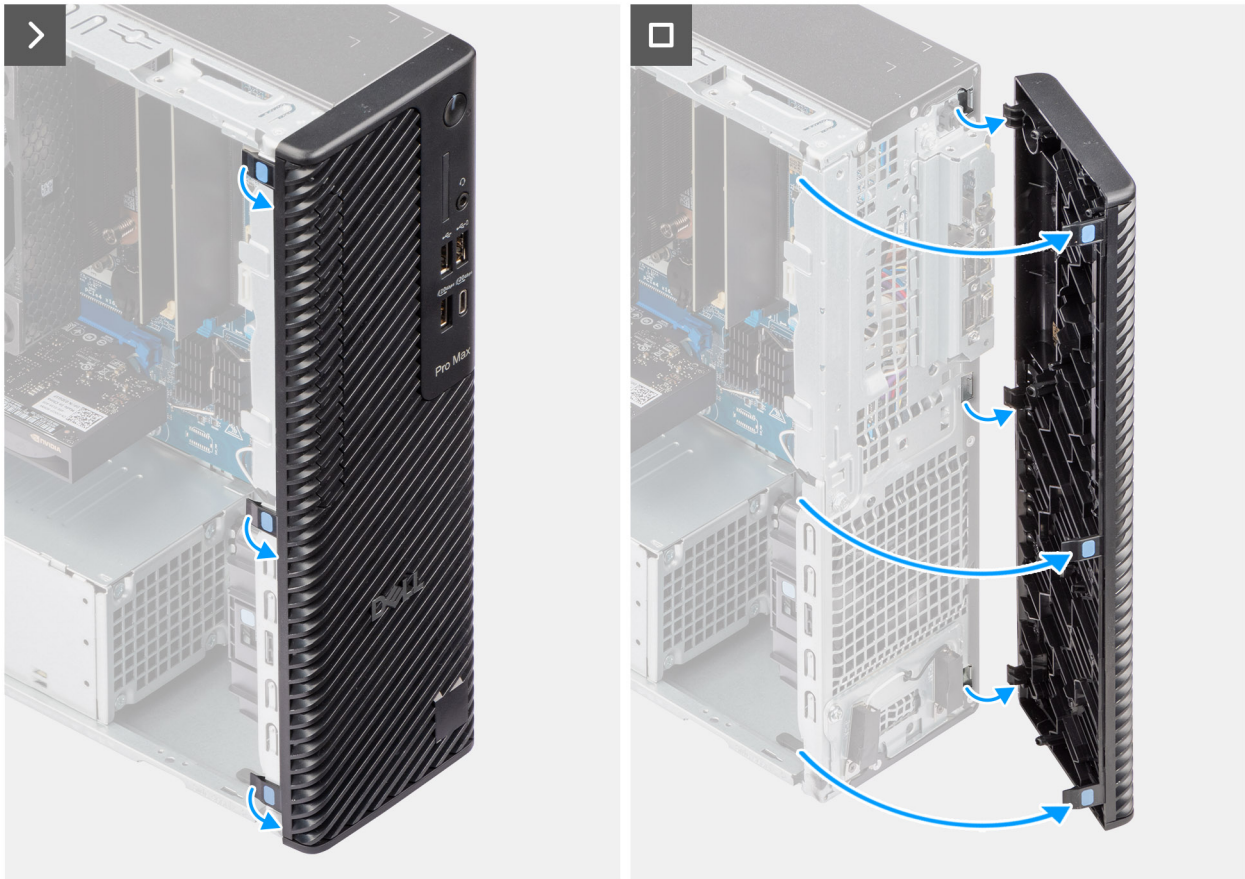

**Figure 15. Removing the front cover**

**Steps**

1. Pry the retention tabs to release the front cover from the computer.
2. Slightly pull the front cover and gently rotate it to release the other tabs on the cover from the slots in the computer chassis.
3. Remove the front cover from the computer.

## Installing the front cover

**Prerequisites**

If you are replacing a component, remove the existing component before performing the installation procedure.

**About this task**

The following images indicate the location of the front cover and provide a visual representation of the installation procedure.

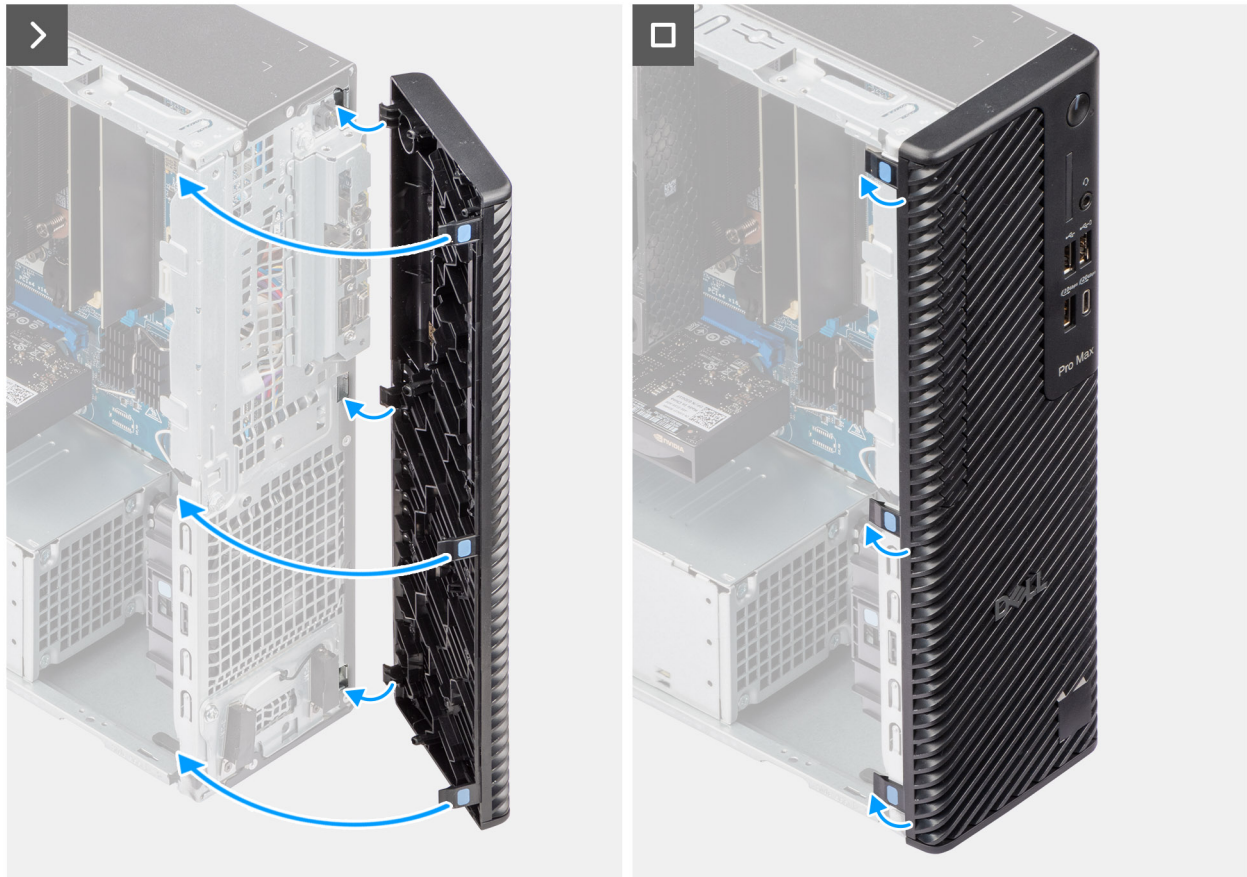

**Figure 16. Installing the front cover**

#### **Steps**

1. Position the front cover to align the tabs on the cover with the slots on the chassis.
2. Press the cover until the tabs clicks into place.

#### **Next steps**

1. Install the [side cover](#).
2. Follow the procedure in [after working inside your computer](#).

## **Optical drive**

### **Removing the optical drive**

#### **Prerequisites**

1. Follow the procedure in [Before working inside your computer](#).
2. Remove the [side cover](#).

3. Remove the front cover.

**About this task**

**NOTE:** The optical drive is located within the disk bay.

The following images indicate the location of the optical drive and provide a visual representation of the removal procedure.

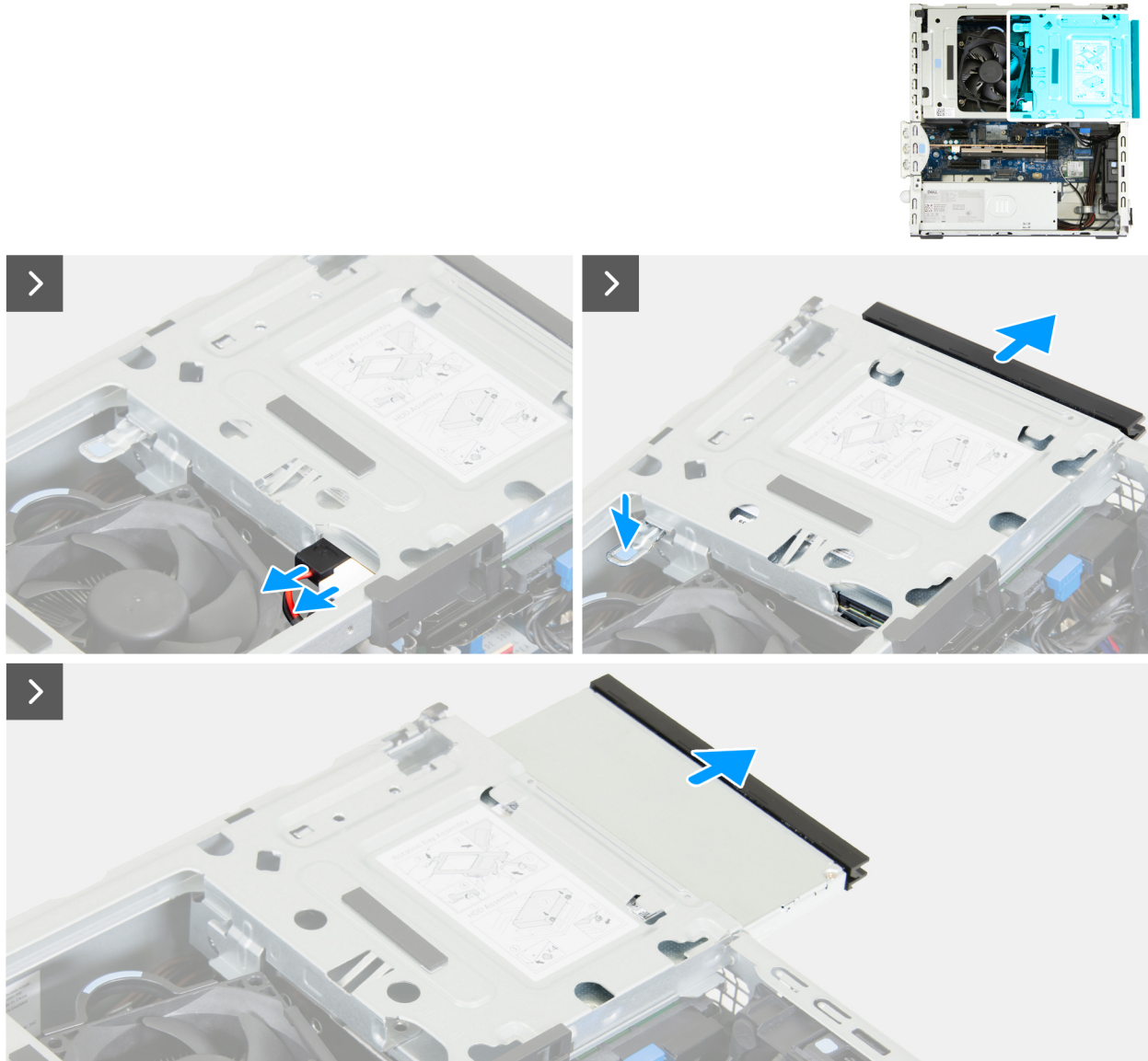

**Figure 17. Removing the optical drive**



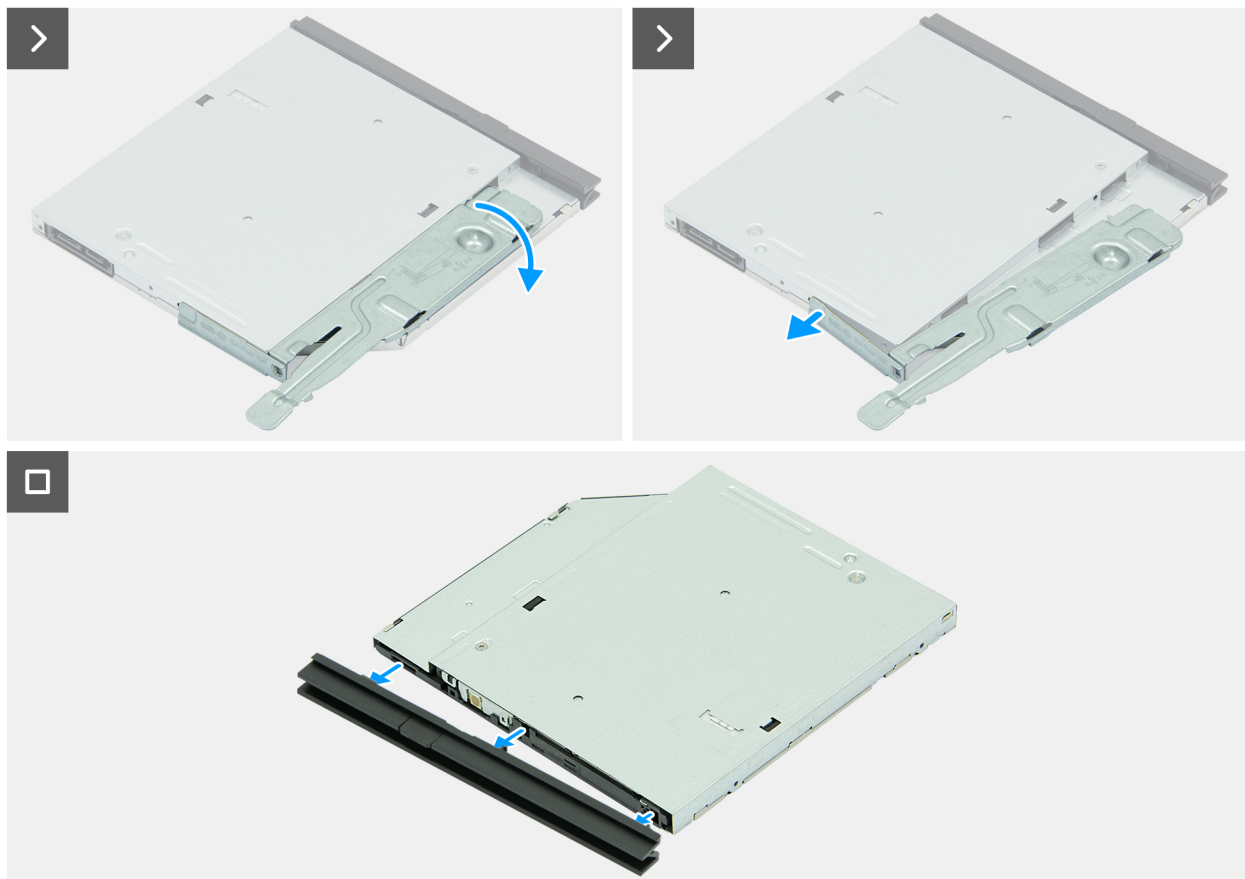

**Figure 18. Removing the optical drive**

### Steps

1. Disconnect the data cable and the power cable from the optical drive.
2. Press down on the securing tab to release the optical drive from the drive bay.
3. Pull to slide the optical drive out of the drive bay.
4. Flip the optical drive over to reveal the securing tab.
5. Rotate the securing tab to release it from the optical drive.
6. Gently pull the bezel from the optical drive.

## Installing the optical drive

### Prerequisites

If you are replacing a component, remove the existing component before performing the installation procedure.

### About this task

**NOTE:** The optical drive is located within the drive bay. Follow the below-mentioned procedure **on the disk-drive cage** to remove or install the optical drive.

The following images indicate the location of the optical drive and provide a visual representation of the installation procedure.



Figure 19. Installing the optical drive

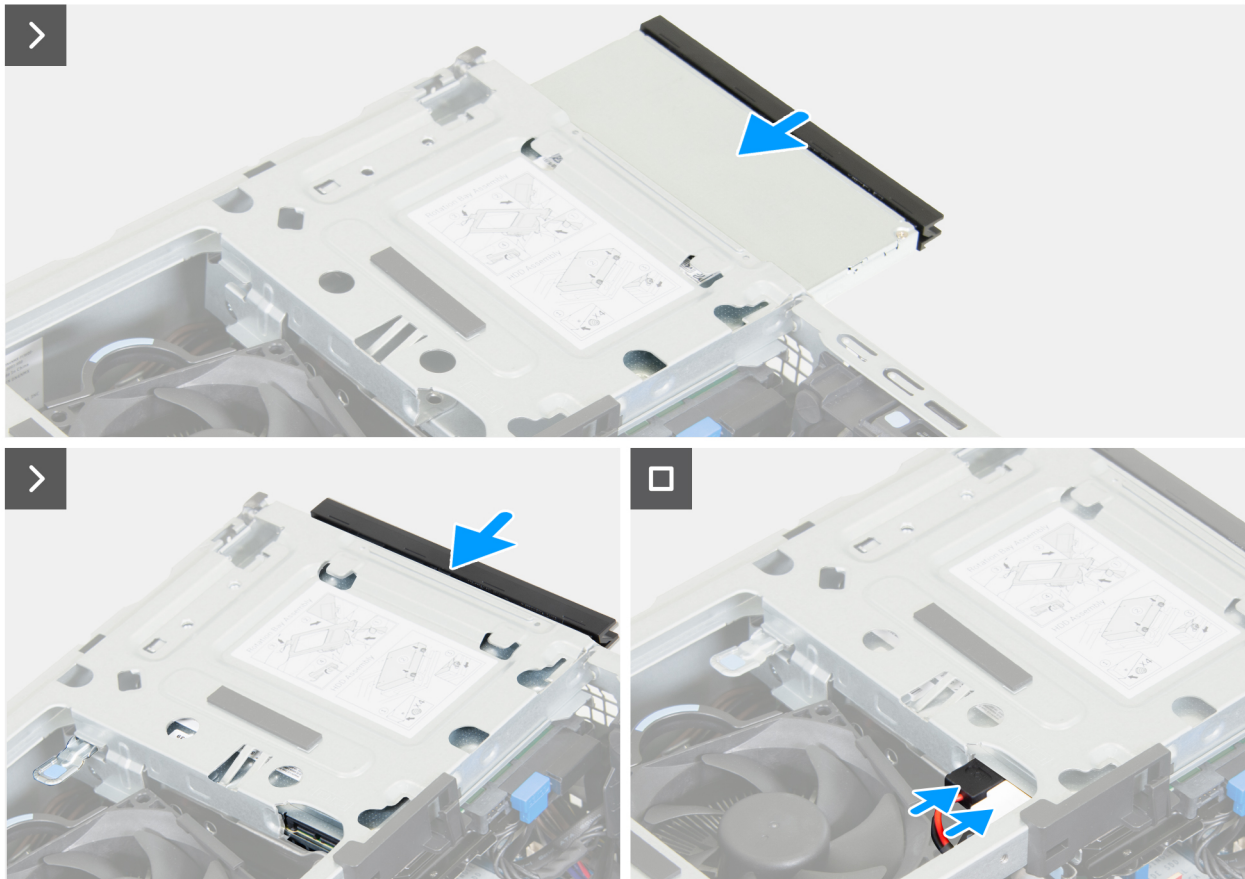

**Figure 20. Installing the optical drive**

#### Steps

1. Align the tabs on the bezel with the slots on the optical drive.
2. Press the bezel against the optical drive until the bezel clicks into place.
3. Insert the alignment post on the securing tab into the hole on the optical drive.
4. Rotate the securing tab inward until it clicks into place.
5. Slide the optical drive into the drive bay until the optical drive clicks into place.
6. Connect the data cable and the power cable to the optical drive.

#### Next steps

1. Install the [front cover](#).
2. Install the [side cover](#).
3. Follow the procedure in [After working inside your computer](#).

## Drive bay

### Removing the drive bay

#### Prerequisites

1. Follow the procedure in [before working inside your computer](#).
2. Remove the [side cover](#).
3. Remove the [front cover](#).

**About this task**

The following images indicate the location of the drive bay and provide a visual representation of the removal procedure.

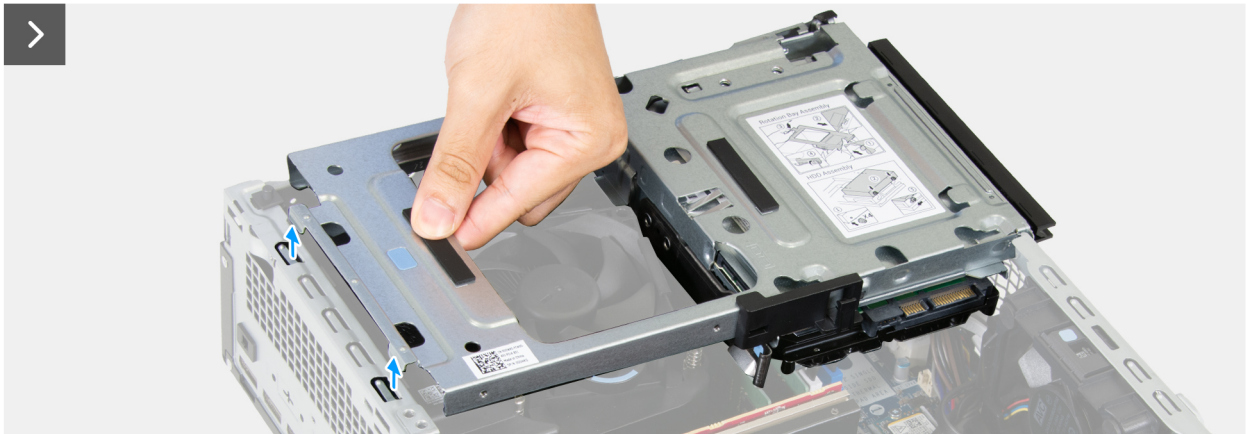
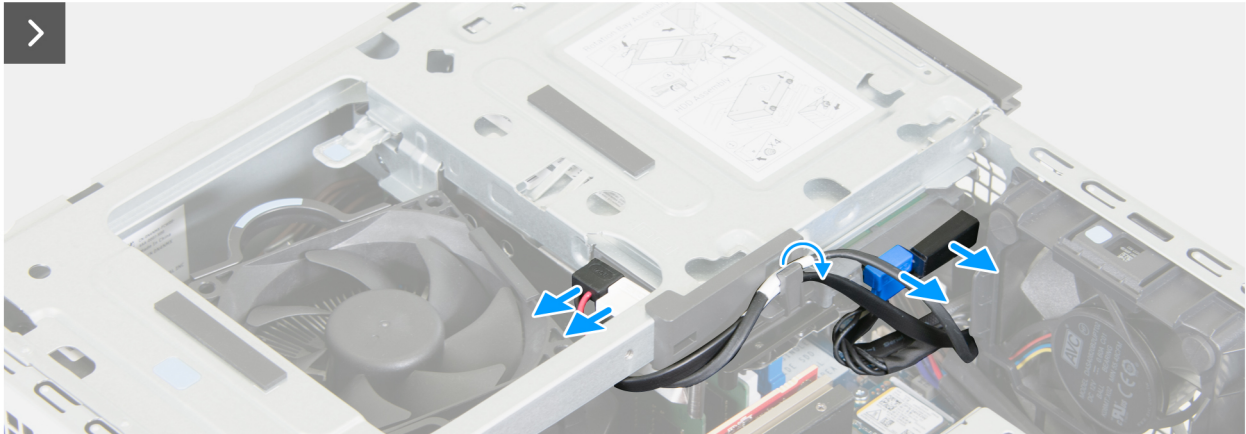

**Figure 21. Removing the drive bay**

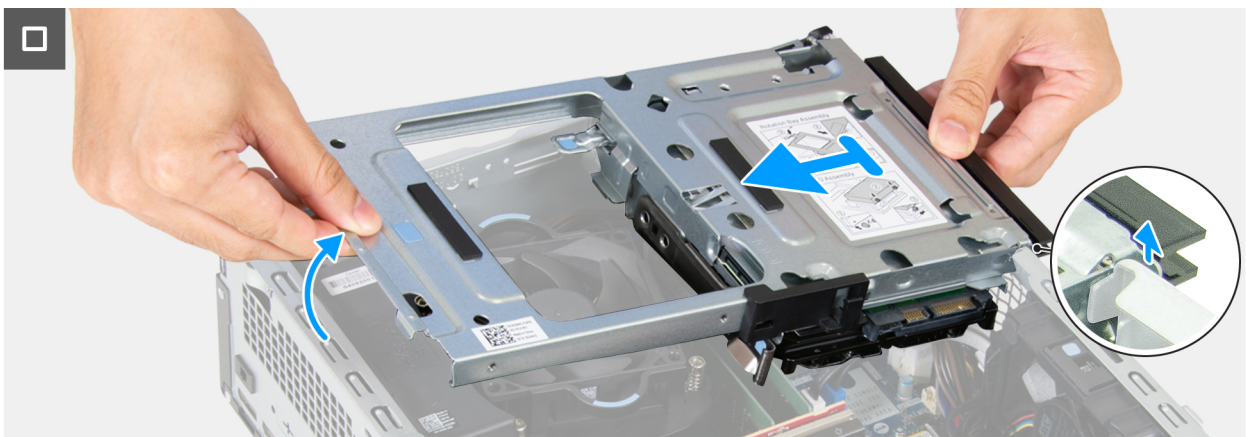

**Figure 22. Removing the drive bay**



## Steps

1. Disconnect the data cable and the power cable from the optical drive.
2. Remove the data cable and the power cable from the routing guide on the drive bay.
3. Disconnect the data cable and the power cable from the hard drive.
4. Lift the drive bay at an angle to release the tabs from the chassis.
5. Hold the drive bay firmly with both hands, lift, and slide the drive bay from the chassis.

## Installing the drive bay

### Prerequisites

If you are replacing a component, remove the existing component before performing the installation process.

### About this task

The following images indicate the location of the drive bay and provide a visual representation of the installation procedure.

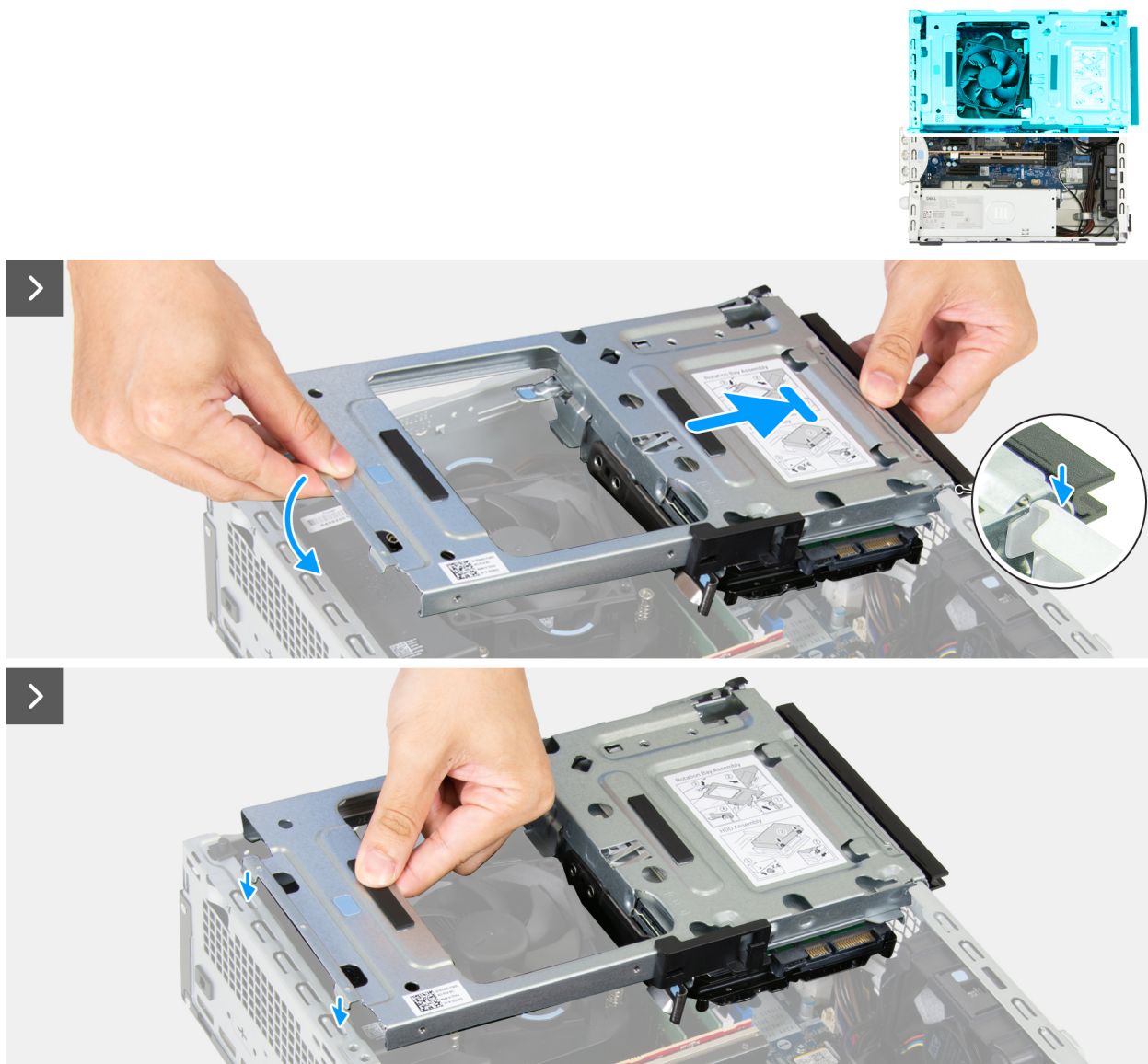

Figure 23. Installing the drive bay





**Figure 24. Installing the drive bay**

### Steps

1. Holding the drive bay firmly with both hands, slide and secure one side of the drive bay to the chassis.
2. Press down the other end of the drive bay securing the tabs on the drive bay with the slots on the chassis.
3. Connect the data cable and the power cable to the hard drive.
4. Connect the data cable and the power cable to the optical drive.
5. Route the data cable and the power cable through the routing guide on the drive bay.

### Next steps

1. Install the [front cover](#).
2. Install the [side cover](#).
3. Follow the procedure in [after working inside your computer](#).

## Internal speaker

### Removing the internal speaker

#### Prerequisites

1. Follow the procedure in [Before working inside your computer](#).
2. Remove the [side cover](#).

#### About this task

The following images indicate the location of the internal speaker and provide a visual representation of the removal procedure.

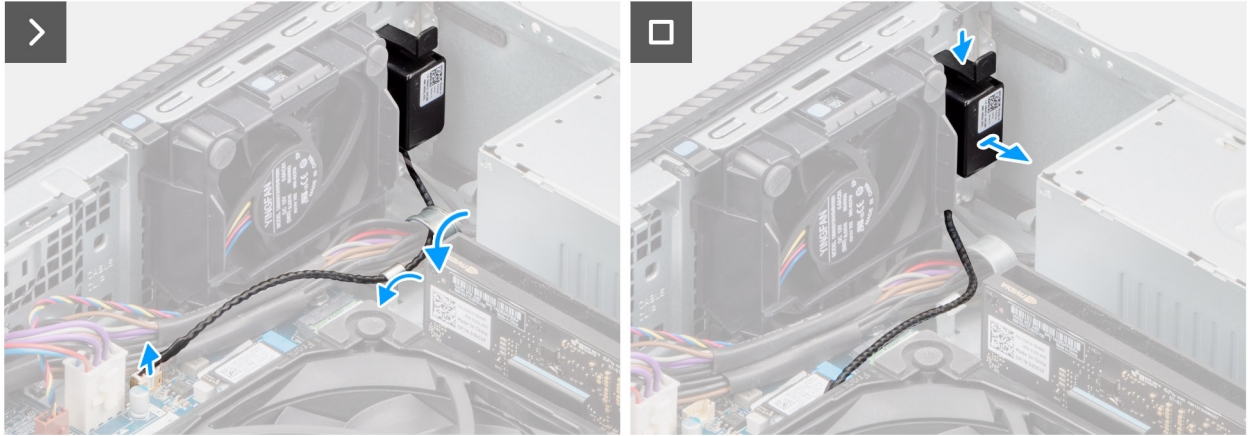
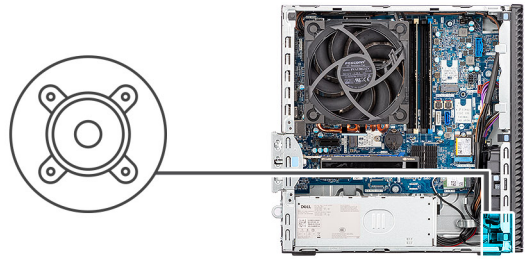

**Figure 25. Removing the internal speaker**

### Steps

1. Disconnect the internal-speaker cable from its connector (INT SPKR) on the system board.
2. Remove the speaker cable from the routing guides on the chassis.
3. While pressing the tab, slide and remove the internal speaker along with the cable from the slot on the chassis.

## Installing the internal speaker

### Prerequisites

If you are replacing a component, remove the existing component before performing the installation procedure.

### About this task

The following images indicate the location of the internal speaker and provide a visual representation of the installation procedure.

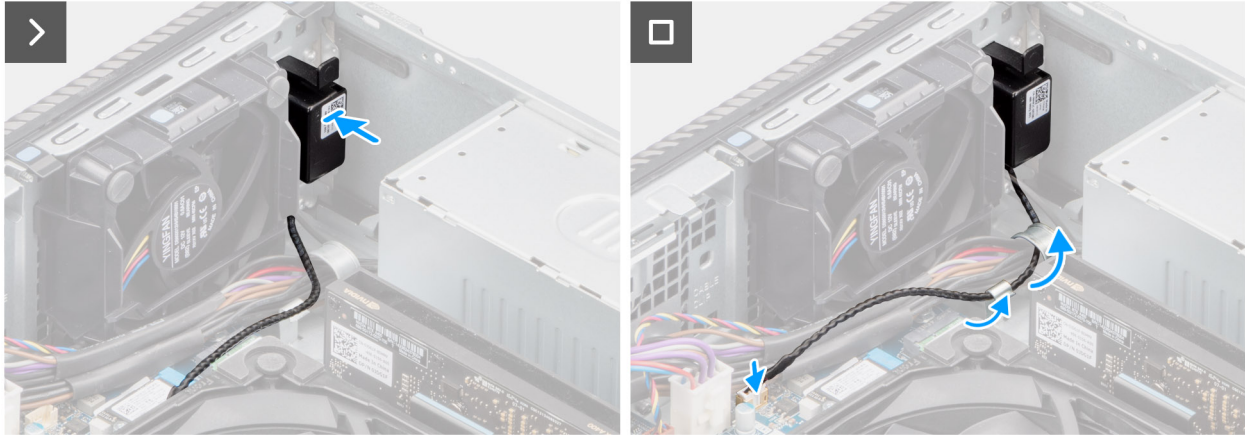
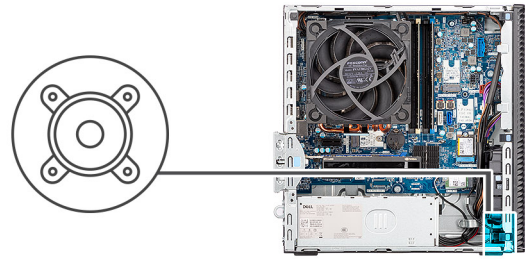

**Figure 26. Installing the internal speaker**

### Steps

1. Place and slide the internal speaker into the bracket on the chassis.
2. Route the speaker cable through the routing guide on the chassis.
3. Press the tab on the speaker and slide the speaker into the slot on the chassis until it snaps into place.
4. Connect the internal-speaker cable to its connector (INT SPKR) on the system board.

### Next steps

1. Install the [side cover](#).
2. Follow the procedure in [After working inside your computer](#).

## Memory

### Removing the memory module

#### Prerequisites

1. Follow the procedure in [Before working inside your computer](#).
2. Remove the [side cover](#).
3. Remove the [front cover](#).
4. Remove the [drive-bay](#).

#### About this task

The following images indicate the location of the memory modules and provide a visual representation of the removal procedure.

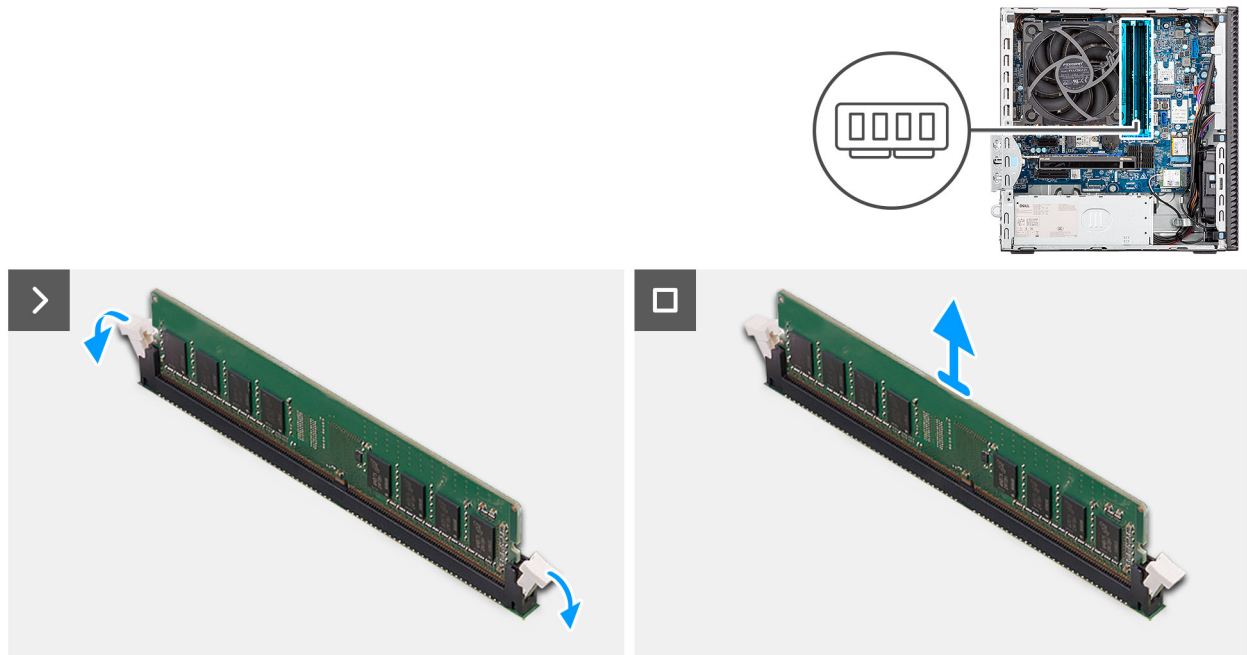

**Figure 27. Removing a memory module**

**Steps**

1. Pull the securing clips from both sides of the memory module until the memory module pops up.
2. Slide and remove the memory module from the memory-module slot.

**CAUTION:** To prevent damage to the memory module, hold the memory module by the edges. Do not touch the components or metallic contacts on the memory module as electrostatic discharge (ESD) can inflict severe damage on the components. To read more about ESD protection, see [ESD protection](#).

**NOTE:** If the memory module is difficult to remove, gently wriggle the memory module back and forth to remove it from the slot.

**NOTE:** Note the slot and the orientation of the memory module in order to replace it in the correct slot.

3. Repeat steps 1 and 2 to remove other memory modules installed in your computer.

## Installing the memory module

**Prerequisites**

If you are replacing a component, remove the existing component before performing the installation procedure.

**About this task**

The following images indicate the location of the memory modules and provide a visual representation of the installation procedure.

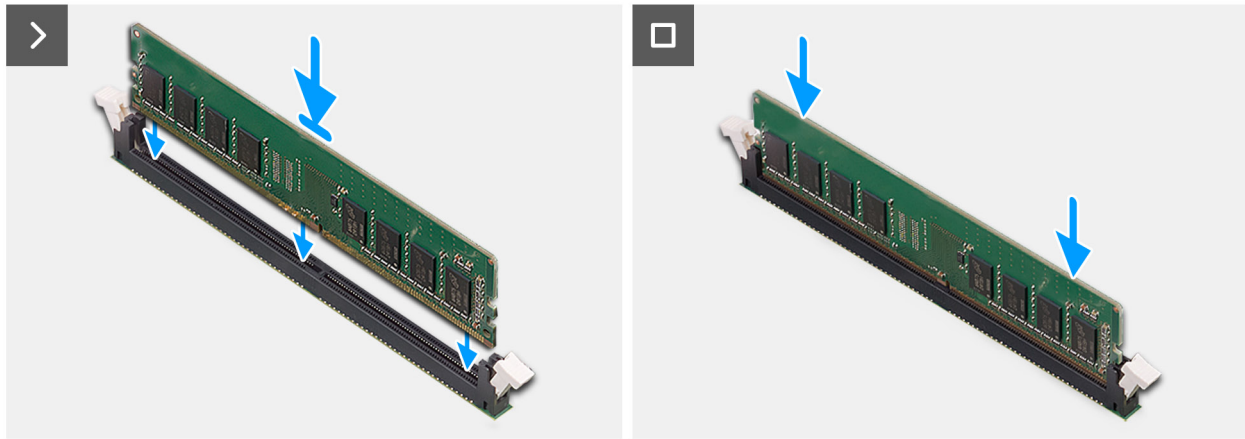
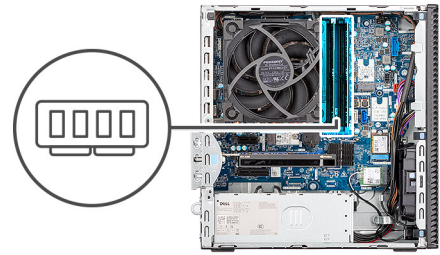

**Figure 28. Installing the memory module**

### Steps

1. Ensure that the memory-module securing clips are in an open position.
2. Align the notch on the memory module with the tab on the memory-module slot (DIMM1, DIMM2, DIMM3, or DIMM4, whichever is applicable).
3. Press down on the memory module until the memory module snaps into position and the securing clips lock in place.

**CAUTION:** To prevent damage to the memory module, hold the memory module by the edges. Do not touch the components or metallic contacts on the memory module as electrostatic discharge (ESD) can inflict severe damage on the components. To read more about ESD protection, see [ESD protection](#).

**NOTE:** If you do not hear the click, remove the memory module and reinstall it.

4. Repeat steps 1 to 3 to install other memory modules in your computer, if applicable.

### Next steps

1. Install the [drive bay](#).
2. Install the [front cover](#).
3. Install the [side cover](#).
4. Follow the procedure in [After working inside your computer](#).

## Hard drive

### Removing the hard drive

#### Prerequisites

1. Follow the procedure in [Before working inside your computer](#).
2. Remove the [side cover](#).
3. Remove the [front cover](#).
4. Remove the [drive-bay](#).



### About this task

The following images indicate the location of the hard drive and provide a visual representation of the removal procedure.



Figure 29. Removing the hard drive

### Steps

1. Flip the drive bay over to reveal the hard drive.
2. Pull the securing tab away from the side of the hard drive.
3. Slide and lift the hard disk at an angle off the drive-bay.
4. Remove the four screws (6-32#) from the hard drive.

## Installing the hard drive

### Prerequisites

If you are replacing a component, remove the existing component before performing the installation procedure.

### About this task

The following images indicate the location of the hard drive and provide a visual representation of the installation procedure.



4x  
6-32#



**Figure 30. Installing the hard drive**

**Steps**

1. Replace the four screws (6-32#) on the hard drive.
2. Align the screws on the hard drive with the grooves on the drive-bay.
3. In an angle, align and slide the hard drive into the drive-bay.

**Next steps**

1. Install the [drive bay](#).
2. Install the [front cover](#).
3. Install the [side cover](#).
4. Follow the procedure in [After working inside your computer](#).

# Solid state drive

## Removing the M.2 2230 solid state drive from slot 0

### Prerequisites

1. Follow the procedure in [Before working inside your computer](#).
2. Remove the [side cover](#).
3. Remove the [drive bay](#).

### About this task

The following images indicate the location of the M.2 2230 solid state drive in slot 0 and provide a visual representation of the removal procedure.

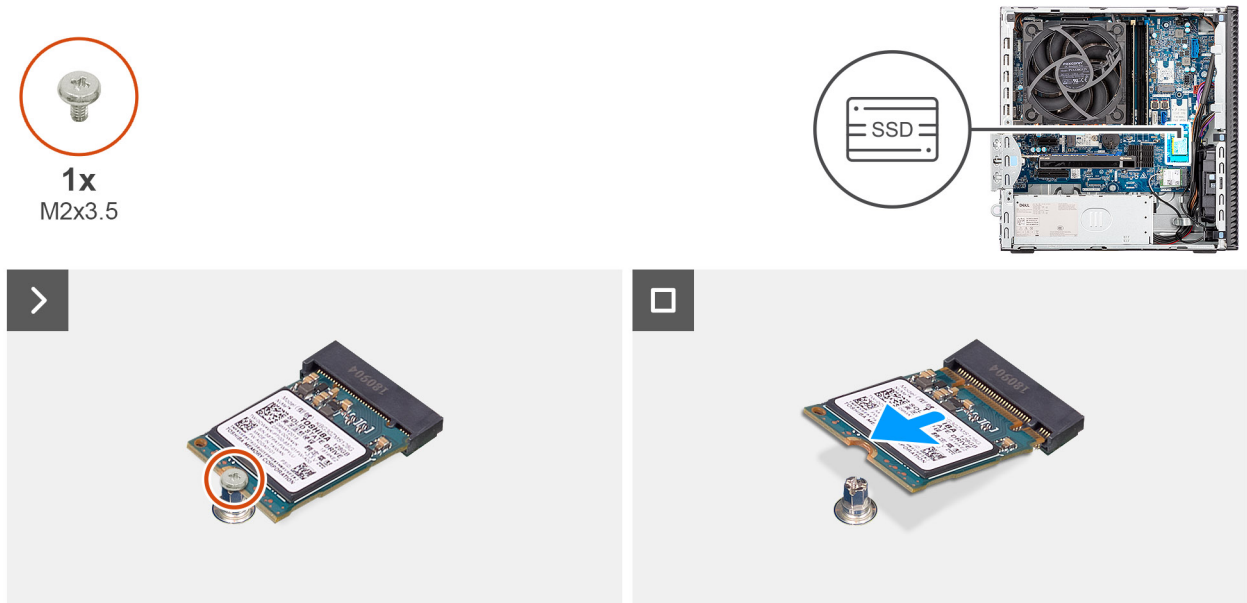

Figure 31. Removing the M.2 2230 solid state drive

### Steps

1. Remove the screw (M2x3.5) that secures the M.2 2230 solid state drive to the system board.
2. Slide and lift the M.2 2230 solid state drive off the solid state drive slot 0 (M.2 PCIe SSD-0) on the system board.

## Installing the M.2 2230 solid state drive in slot 0

### Prerequisites

If you are replacing a component, remove the existing component before performing the installation procedure.

### About this task

**NOTE:** Steps 1 to 3 are applicable only if you are installing a new M.2 2230 solid state drive for the first time in your computer.

The following images indicate the location of the M.2 2230 solid state drive in slot 0 and provide a visual representation of the installation procedure.





1x  
M2x3.5

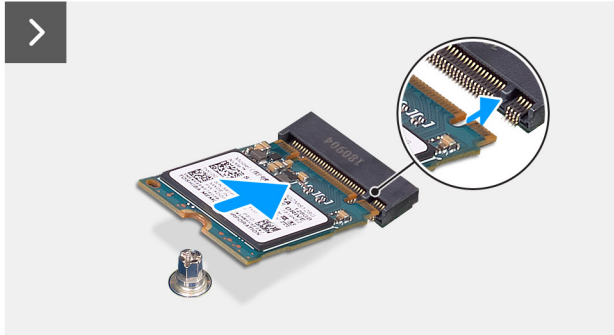

**Figure 32. Installing the M.2 2230 solid state drive in slot 0**

### Steps

1. Peel off the protection film on the thermal pad.
  2. Align and adhere the thermal pad on the solid state drive slot 0 (M.2 PCIE SSD-0) on the system board.
- i NOTE:** The thermal pad is re-usable. The thermal pad is preinstalled on computers that are shipped with solid state drive. If the solid state drive is purchased separately, the thermal pad is not bundled with the solid state drive kit and must be purchased separately.

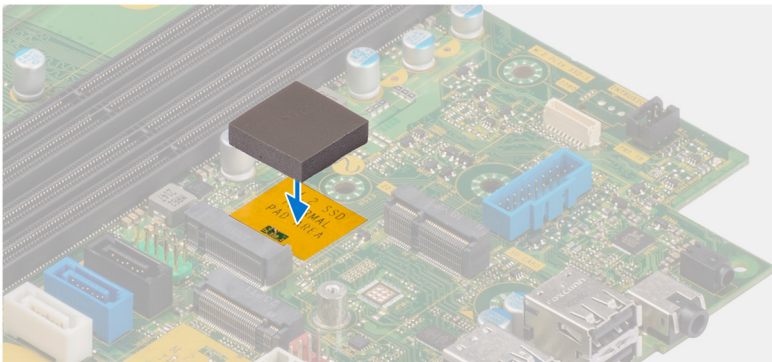

3. Peel off the protective Mylar on the thermal pad.
4. Align the notch on the M.2 2230 solid state drive with the tab on the solid state drive slot 0 (M.2 PCIE SSD-0) on the system board.
5. Slide the M.2 2230 solid state drive into the solid state drive slot 0 (M.2 PCIE SSD-0) on the system board.
6. Replace the screw (M2x3.5) that secures the M.2 2230 solid state drive to the system board.

### Next steps

1. Install the [drive bay](#).
2. Install the [side cover](#).
3. Follow the procedure in [After working inside your computer](#).

# Removing the M.2 2230 solid state drive from slot 1

## Prerequisites

1. Follow the procedure in [Before working inside your computer](#).
2. Remove the [side cover](#).
3. Remove the [drive bay](#).

## About this task

The following images indicate the location of the M.2 2230 solid state drive in slot 1 and provide a visual representation of the removal procedure.

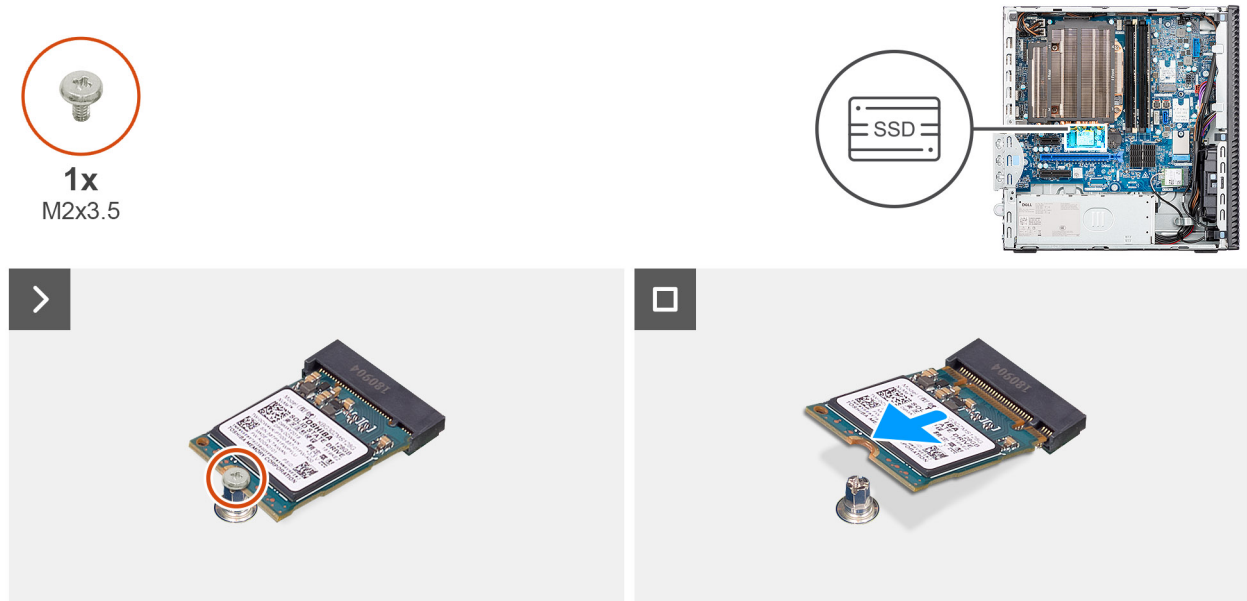

Figure 33. Removing the M.2 2230 solid state drive

## Steps

1. Remove the screw (M2x3.5) that secures the M.2 2230 solid state drive to the system board.
2. Slide and lift the M.2 2230 solid state drive off the solid state drive slot 0 (M.2 PCIE SSD-1) on the system board.

# Installing the M.2 2230 solid state drive in slot 1

## Prerequisites

If you are replacing a component, remove the existing component before performing the installation procedure.

## About this task

**NOTE:** Steps 1 to 3 are applicable only if you are installing a new M.2 2230 solid state drive for the first time in your computer.

The following images indicate the location of the M.2 2230 solid state drive in slot 1 and provide a visual representation of the installation procedure.

**NOTE:** The thermal pad is re-usable. The thermal pad is preinstalled on computers that are shipped with solid state drive. If the solid state drive is purchased separately, the thermal pad is not bundled with the solid state drive kit and must be purchased separately.

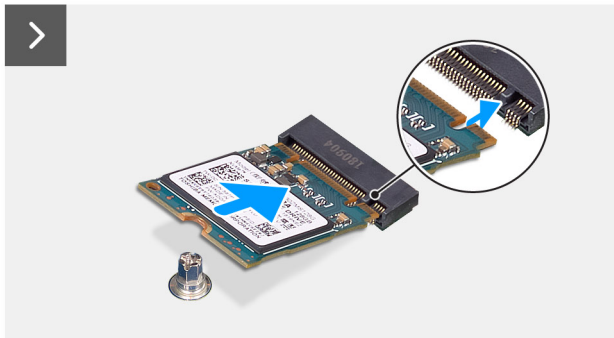
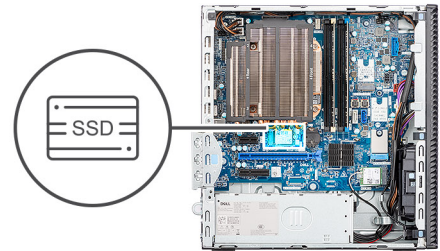
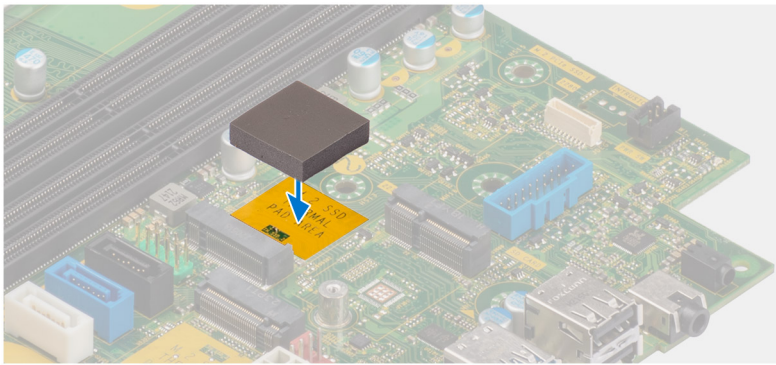

**Figure 34. Installing the M.2 2230 solid state drive in slot 1**

### Steps

1. Peel off the protection film on the thermal pad.
2. Align and adhere the thermal pad on the solid state drive slot 1 (M.2 PCIE SSD-1) on the system board.
3. Peel off the protective Mylar on the thermal pad.
4. Align the notch on the M.2 2230 solid state drive with the tab on the solid state drive slot 1 (M.2 PCIE SSD-1) on the system board.
5. Slide the M.2 2230 solid state drive into the solid state drive slot 1 (M.2 PCIE SSD-1) on the system board.
6. Replace the screw (M2x3.5) that secures the M.2 2230 solid state drive to the system board.

### Next steps

1. Install the [drive bay](#).
2. Install the [side cover](#).
3. Follow the procedure in [After working inside your computer](#).

## Removing the M.2 2280 solid state drive from slot 2

### Prerequisites

1. Follow the procedure in [Before working inside your computer](#).
2. Remove the [side cover](#).
3. Remove the [drive bay](#).

### About this task

The following images indicate the location of the M.2 2280 solid state drive slot 2 and provide a visual representation of the removal procedure.

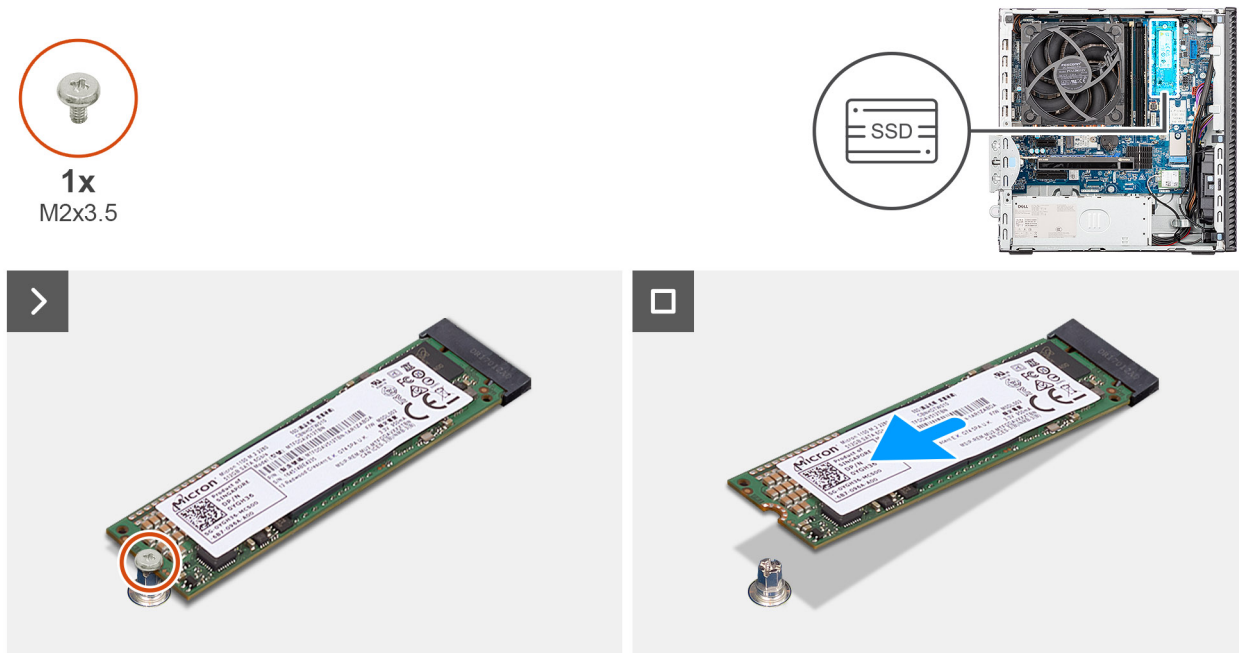

Figure 35. Removing the M.2 2280 solid-state drive

### Steps

1. Remove the screw (M2x3) that secures the M.2 2280 solid state drive to the system board.
2. Slide and lift the M.2 2280 solid state drive off the solid state drive slot 2 (M.2 PCIe SSD-2) on the system board.

## Installing the M.2 2280 solid state drive in slot 2

### Prerequisites

If you are replacing a component, remove the existing component before performing the installation procedure.

### About this task

**NOTE:** Steps 1 to 3 are applicable only if you are installing a new M.2 2280 solid state drive for the first time in your computer.

The following images indicate the location of the M.2 2280 solid state drive slot 2 and provide a visual representation of the installation procedure.

**NOTE:** The thermal pad is re-usable. The thermal pad is preinstalled on computers that are shipped with a solid state drive. If the solid state drive is purchased separately, the thermal pad is not bundled with the solid state drive kit and must be purchased separately.

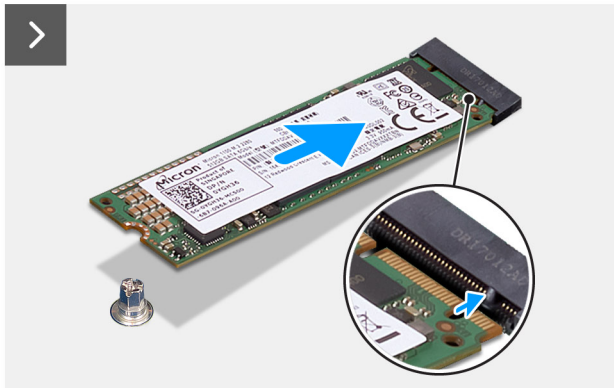
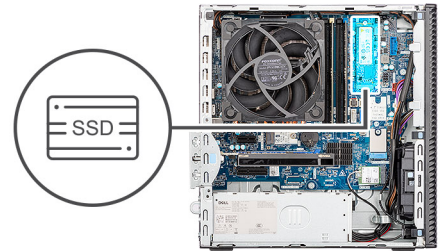
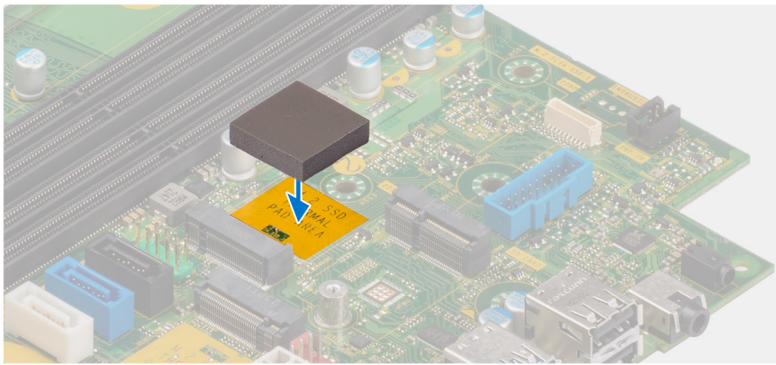

**Figure 36. Installing the M.2 2280 solid-state drive**

**Steps**

1. Peel off the protection film on the thermal pad.
2. Align and adhere the thermal pad on the M.2 2280 solid state drive slot on the system board.
3. Peel off the Mylar protection on the thermal pad.
4. Align the notch on the M.2 2280 solid state drive with the tab on the solid state drive slot 2 (M.2 PCIe SSD-2) on the system board.
5. Slide the M.2 2280 solid state drive into the solid state drive slot 2 (M.2 PCIe SSD-2) on the system board.
6. Replace the screw (M2x3.5) that secures the M.2 2280 solid state drive to the system board.

**Next steps**

1. Install the [drive bay](#).
2. Install the [side cover](#).
3. Follow the procedure in [After working inside your computer](#).

## Removing the M.2 2280 solid state drive from slot 0

**Prerequisites**

1. Follow the procedure in [Before working inside your computer](#).
2. Remove the [side cover](#).
3. Remove the [front cover](#).



4. Remove the [drive bay](#).

#### About this task

The following images indicate the location of the M.2 2280 solid state drive and provide a visual representation of the removal procedure.

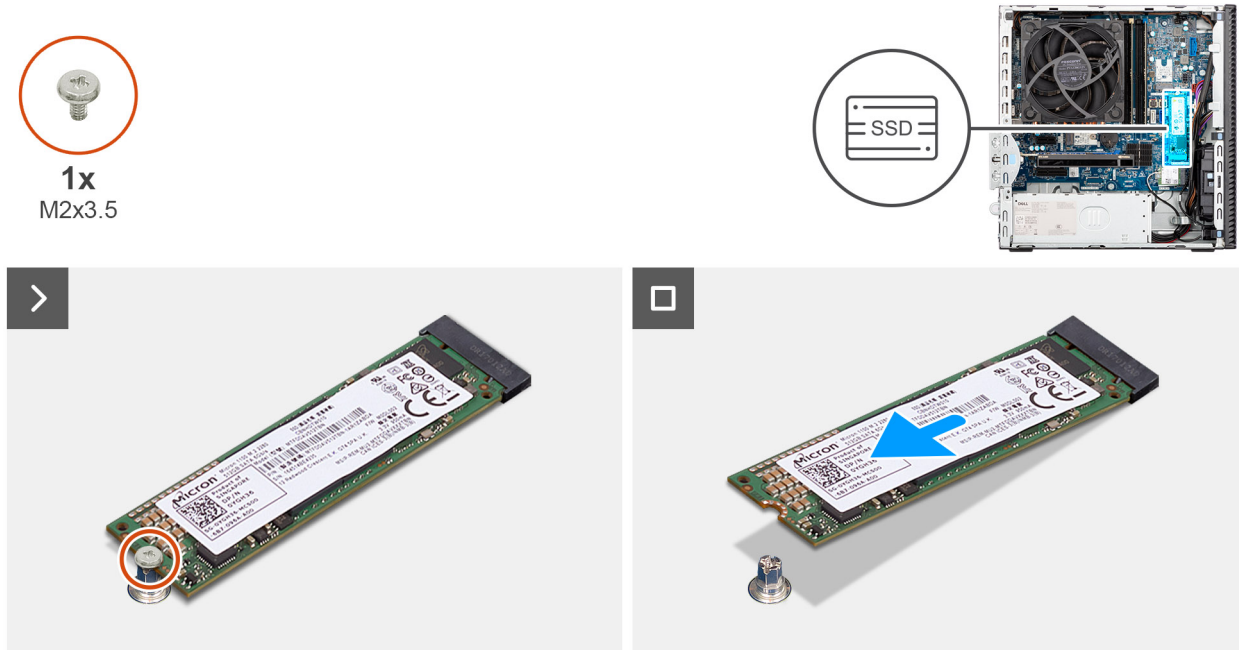

Figure 37. Removing the M.2 2280 solid-state drive

#### Steps

1. Remove the screw (M2x3.5) that secures the M.2 2280 solid state drive to the system board.
2. Slide and lift the M.2 2280 solid state drive off the solid state drive slot (M.2 PCIe SSD-2) on the system board.

## Installing the M.2 2280 solid state drive in slot 0

#### Prerequisites

If you are replacing a component, remove the existing component before performing the installation procedure.

#### About this task

**NOTE:** Steps 1 to 3 are applicable only if you are installing a new M.2 2280 solid state drive for the first time in your computer.

The following images indicate the location of the M.2 2280 solid state drive and provide a visual representation of the installation procedure.

**NOTE:** The thermal pad is re-usable. The thermal pad is preinstalled on computers that are shipped with a solid state drive. If the solid state drive is purchased separately, the thermal pad is not bundled with the solid state drive kit and must be purchased separately.

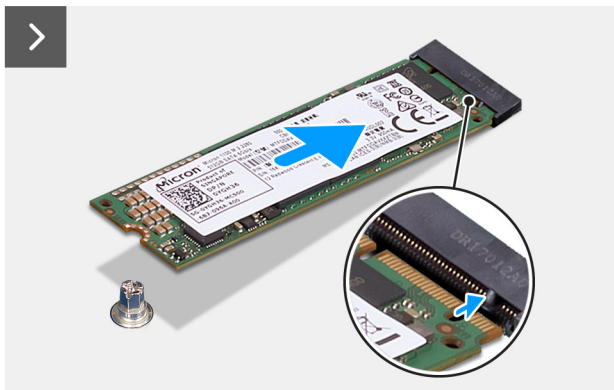
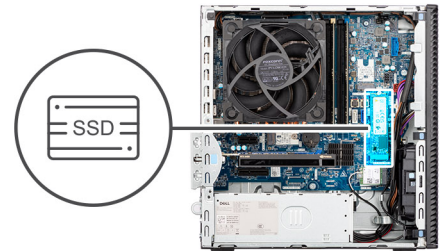
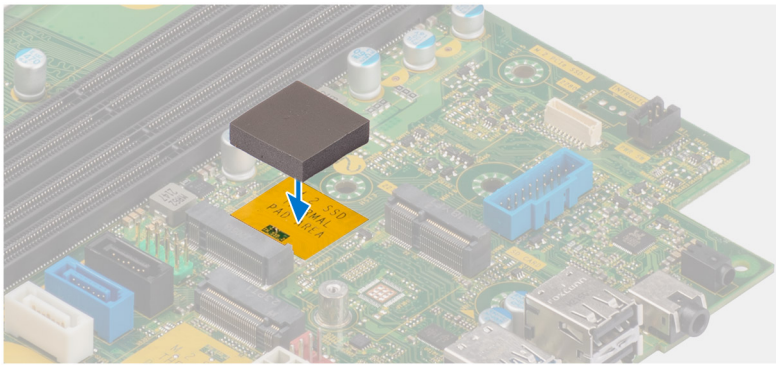

**Figure 38. Installing the M.2 2280 solid-state drive**

**Steps**

1. Peel off the protection film on the thermal pad.
2. Align and adhere the thermal pad on the M.2 2280 solid state drive slot on the system board.
3. Peel off the Mylar protection on the thermal pad.
4. Align the notch on the M.2 2280 solid state drive with the tab on the solid state drive slot (M.2 PCIe SSD-0) on the system board.
5. Slide the M.2 2280 solid state drive into the solid state drive slot (M.2 PCIe SSD-0) on the system board.
6. Replace the screw (M2x3.5) that secures the M.2 2280 solid state drive to the system board.

**Next steps**

1. Install the [drive bay](#).
2. Install the [front cover](#).
3. Install the [side cover](#).
4. Follow the procedure in [After working inside your computer](#).

# Graphics card

## Removing the graphics card

### Prerequisites

1. Follow the procedure in [Before working inside your computer](#).
2. Remove the [side cover](#).

### About this task

The following images indicate the location of the graphics card and provide a visual representation of the removal procedure.

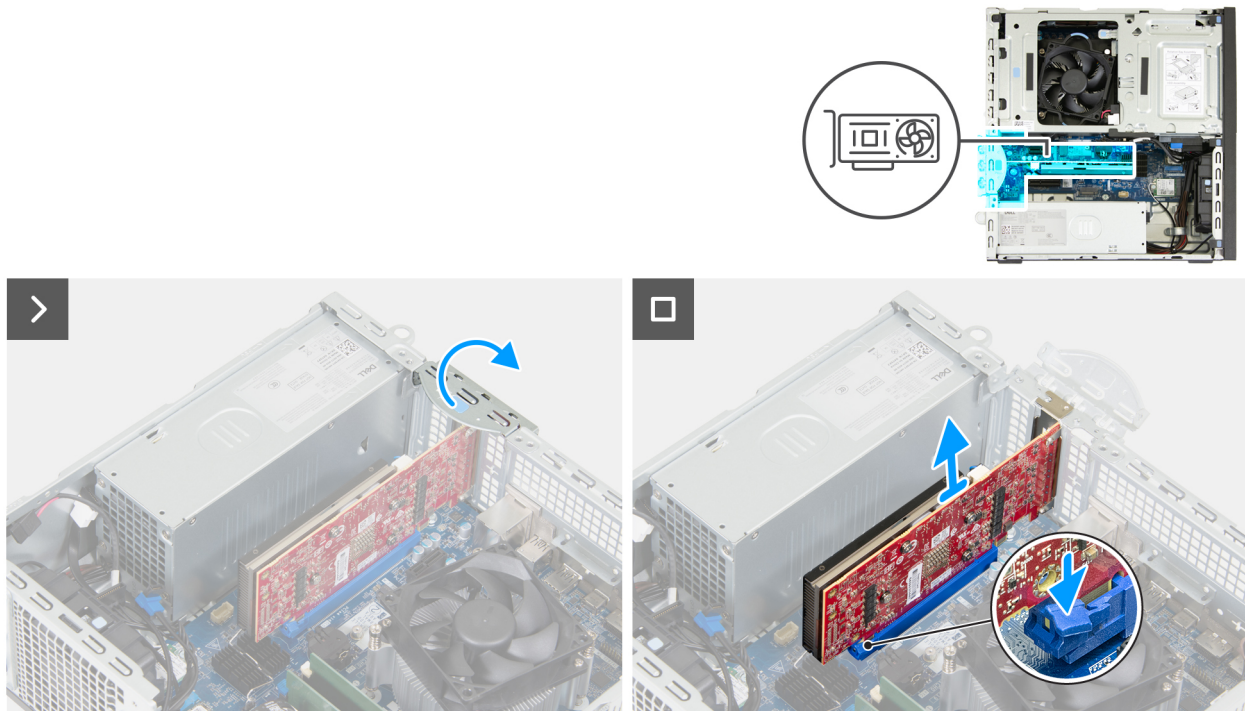

Figure 39. Removing the graphics card

### Steps

1. Open the PCIe latch that secures the graphics card to the PCIe slot (SLOT 2).
2. Push the tab that secures the graphics card to the PCIe card connector (SLOT 2).
3. Gently lift the graphics card off the PCIe card connector (SLOT 2) on the system board.

## Installing the graphics card

### Prerequisites

If you are replacing a component, remove the existing component before performing the installation procedure.

### About this task

The following images indicate the location of the graphics card and provide a visual representation of the installation procedure.





**Figure 40. Installing the graphics card**

**Steps**

1. **NOTE:** Ensure that the PCIe door is in the open position and the release tab on the PCIe card connector (SLOT 2) is up.  
Align the graphics card with the PCIe card connector (SLOT 2) on the system board.
2. Gently press down on the graphics card until the tab on the PCIe card connector (SLOT 2) locks in place.
3. Close the PCIe latch to secure the graphics card in the PCIe slot (SLOT 2).

**Next steps**

1. Install the [side cover](#).
2. Follow the procedure in [After working inside your computer](#).

## Wireless card

### Removing the wireless card

**Prerequisites**

1. Follow the procedure in [Before working inside your computer](#).
2. Remove the [side cover](#).
3. Remove the [drive-bay](#).

**About this task**

The following images indicate the location of the wireless card and provide a visual representation of the removal procedure.



1x  
M2x3.5

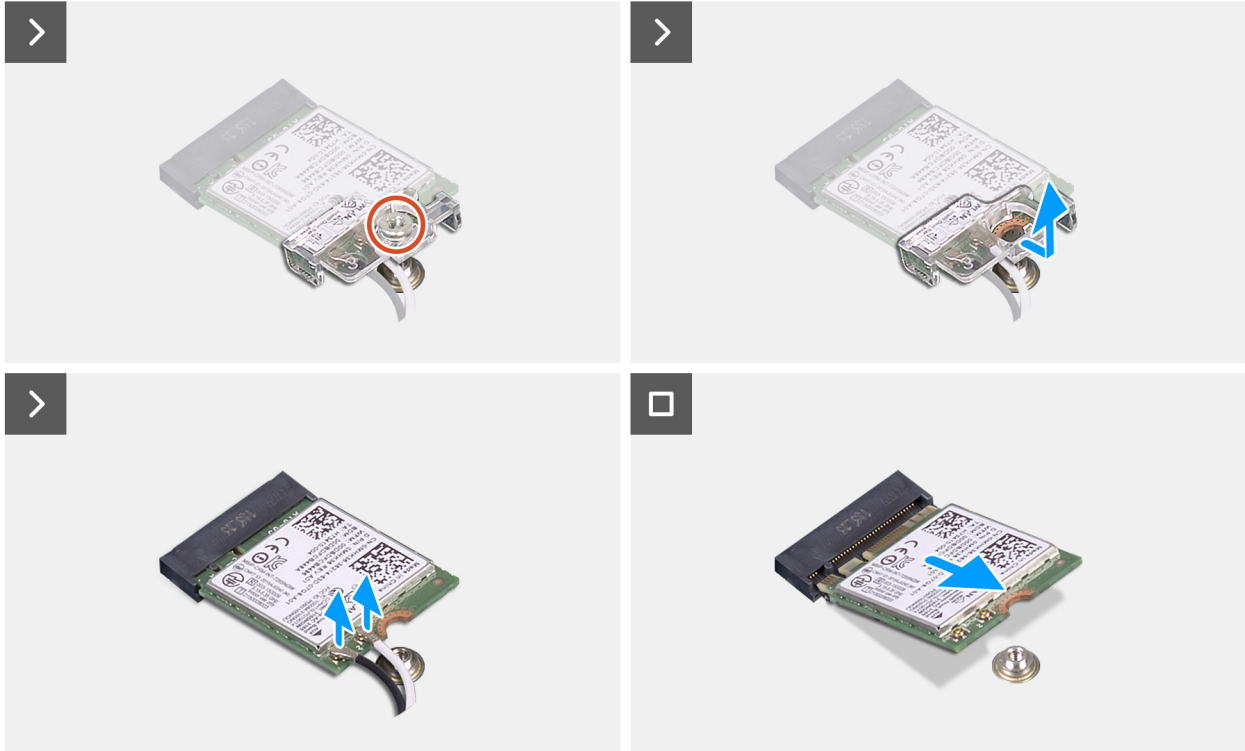

Figure 41. Removing the wireless card

### Steps

1. Remove the screw (M2x3.5) that secures the wireless-card bracket to the system board.
2. Slide and lift the wireless-card bracket off the wireless card.
3. Disconnect the antenna cables from the wireless card.
4. Slide and remove the wireless card from the wireless-card slot (M.2 WLAN) on the system board.

## Installing the wireless card

### Prerequisites

If you are replacing a component, remove the existing component before performing the installation procedure.

### About this task

The following images indicate the location of the wireless card and provide a visual representation of the installation procedure.



1x  
M2x3.5



Figure 42. Installing the wireless card

### Steps

1. Connect the antenna cables to the wireless card.

Table 26. Antenna-cable color scheme

Connector on the wireless card	Antenna-cable color	Silkscreen marking	
Main	White	MAIN	△ (white triangle)
Auxiliary	Black	AUX	▲ (black triangle)

2. Place the wireless-card bracket on the wireless card.
3. Align the notch on the wireless card with the tab on the wireless-card slot (M.2 WLAN).
4. Slide the wireless card at an angle into the wireless-card slot (M.2 WLAN).
5. Replace the screw (M2x3.5) that secures the wireless-card bracket to the wireless card.

### Next steps

1. Install the [drive-bay](#).
2. Install the [side cover](#).
3. Follow the procedure in [After working inside your computer](#).

# Intrusion switch

## Removing the intrusion switch

**CAUTION:** The information in this removal section is intended for authorized service technicians only.

### Prerequisites

1. Follow the procedure in [Before working inside your computer](#).
2. Remove the [side cover](#).

### About this task

The following image indicates the location of the intrusion switch and provides a visual representation of the removal procedure.

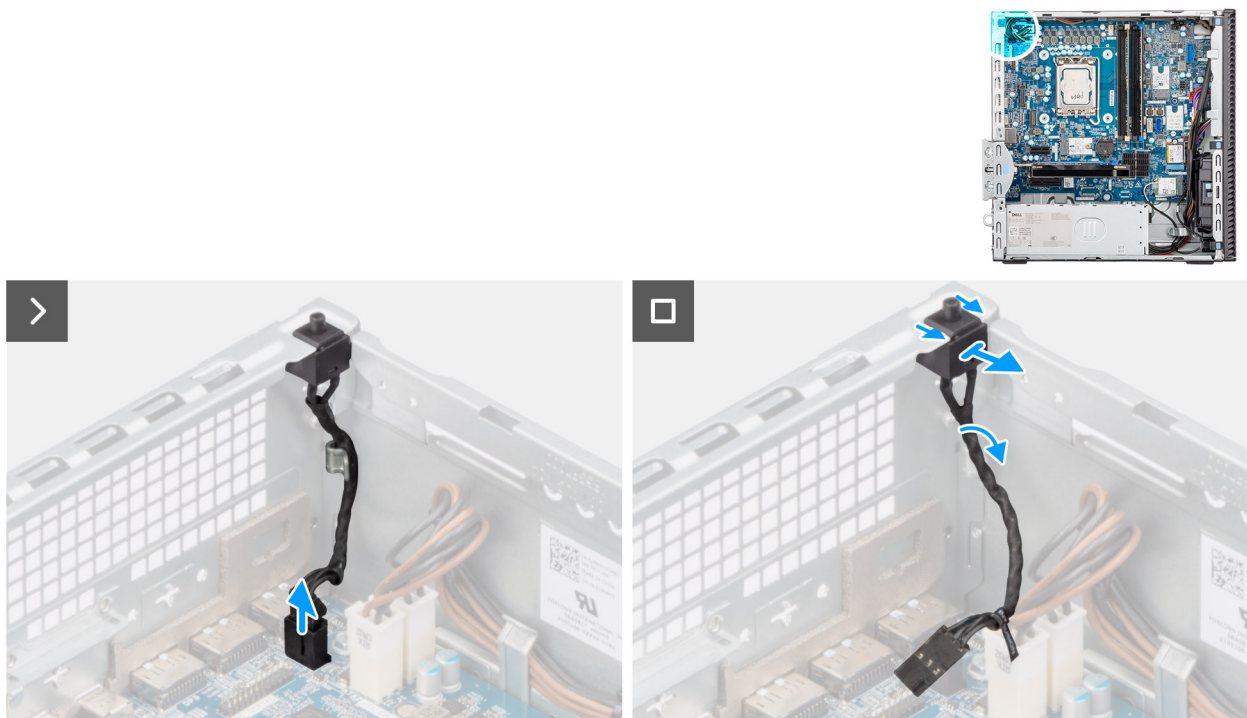

**Figure 43. Removing the intrusion switch**

### Steps

1. Disconnect the intrusion-switch cable from its connector (INTRUSION) on the system board.
2. Remove the intrusion-switch cable from the routing guides on the chassis.
3. Slide and remove the Intrusion switch away from the computer.

## Installing the Intrusion switch

**CAUTION:** The information in this removal section is intended for authorized service technicians only.

### Prerequisites

If you are replacing a component, remove the existing component before performing the installation procedure.

### About this task

The following image indicates the location of the Intrusion switch and provides a visual representation of the installation procedure.

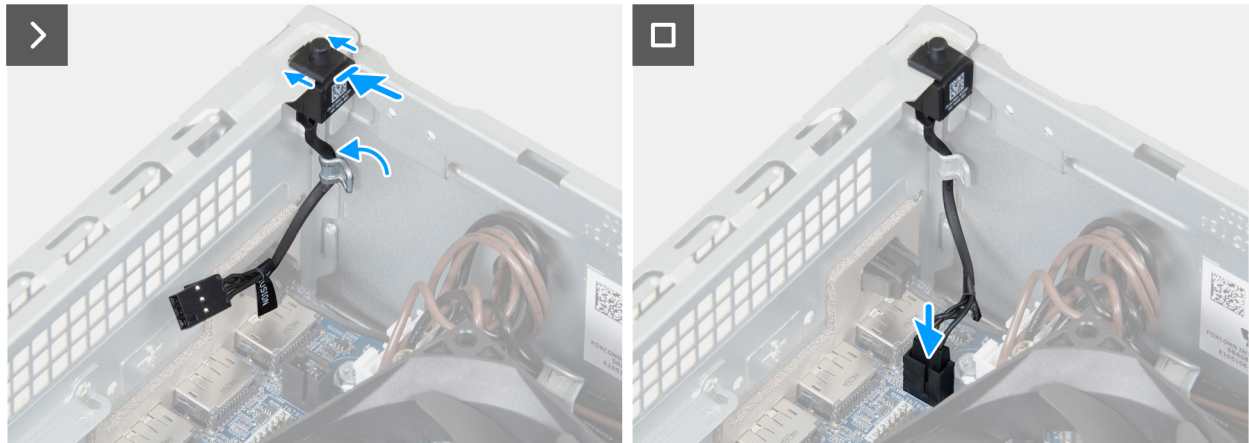

**Figure 44. Installing the Intrusion switch**

### Steps

1. Slide the intrusion switch into the slot on the chassis.
2. Route the intrusion-switch cable through the routing guides on the chassis.
3. Connect the intrusion-switch cable to its connector (INTRUSION) on the system board.

### Next steps

1. Install the [side cover](#).
2. Follow the procedure in [After working inside your computer](#).

## Power button

### Removing the power button

#### Prerequisites

1. Follow the procedure in [before working inside your computer](#).
2. Remove the [side cover](#).
3. Remove the [front cover](#).
4. Remove the [drive-bay](#).

### About this task

The following image indicates the location of the power button and provides a visual representation of the removal procedure.



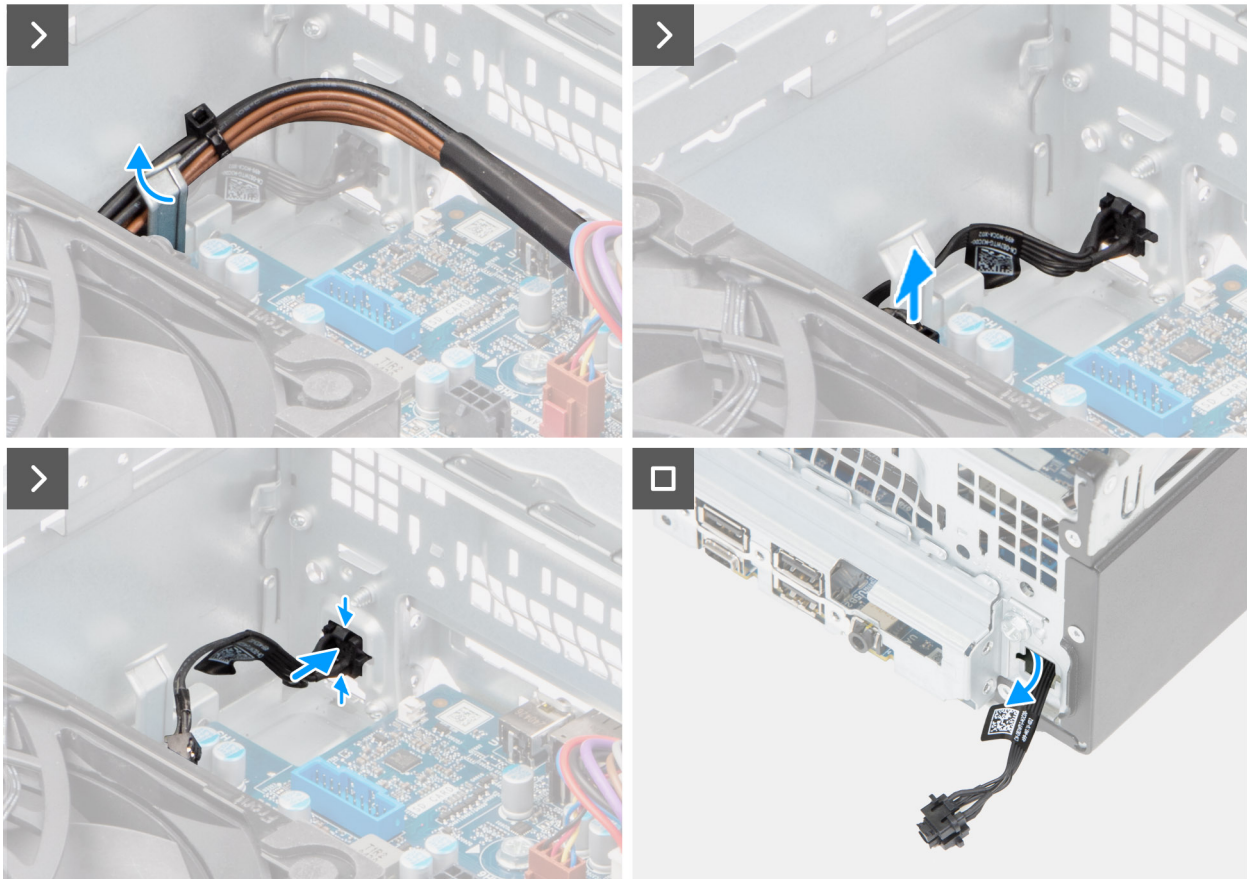
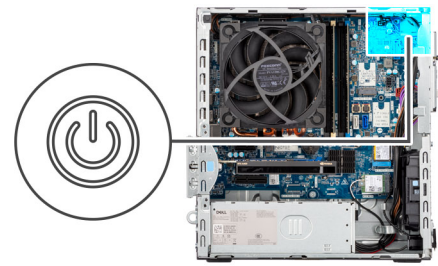

**Figure 45. Removing the power button**

### Steps

1. Remove the processor power cables from the routing guide on the chassis.
2. Move the processor cables off the power-button cable.
3. Disconnect the power-button cable from its connector (PWR SW) on the system board.
4. Pinch the release tabs on the power button to release it from the slot on the chassis.
5. Remove the power button along with its cable through the slot on the front of the chassis.
6. Remove the power button and its cable from the front of the chassis.

## Installing the power button

### Prerequisites

If you are replacing a component, remove the existing component before performing the installation process.

### About this task

The following image indicates the location of the power button and provides a visual representation of the installation procedure.

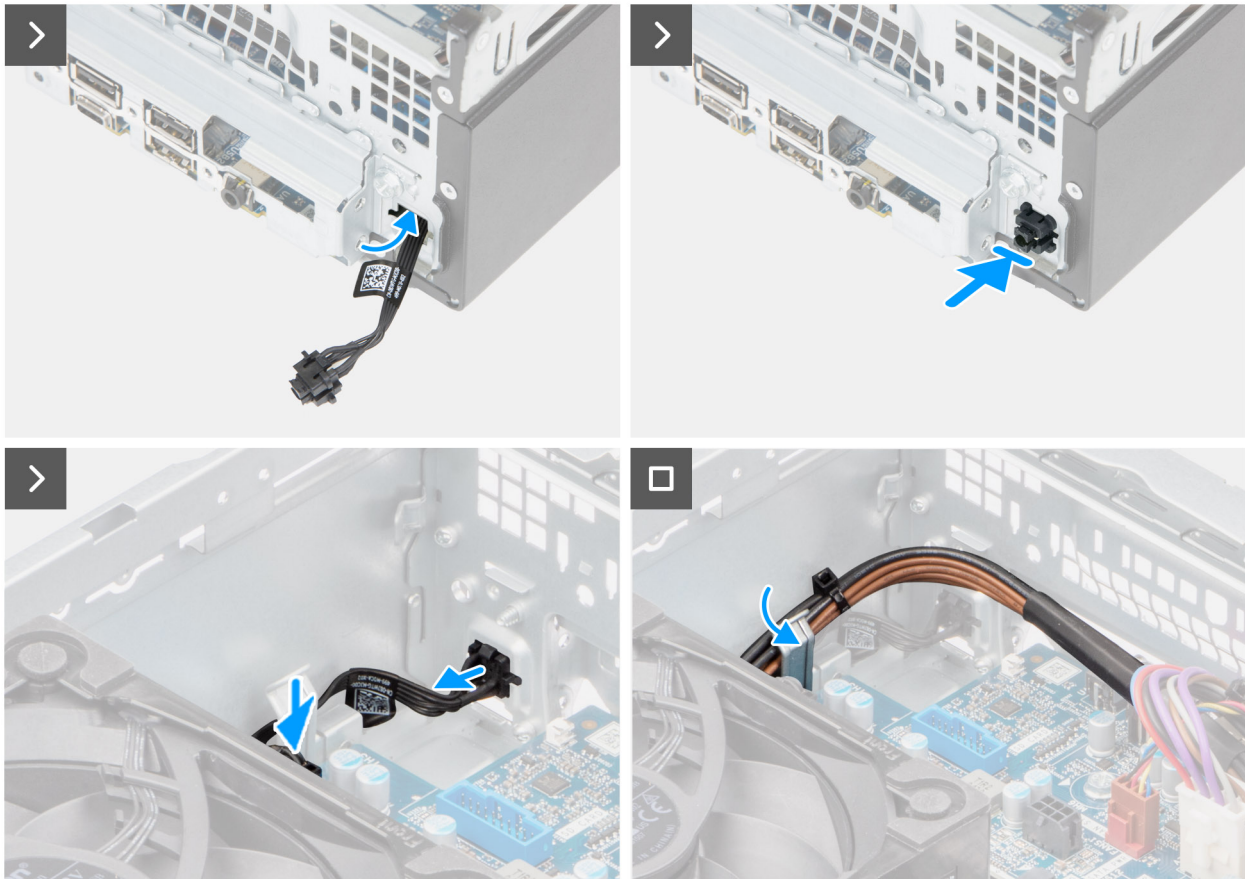
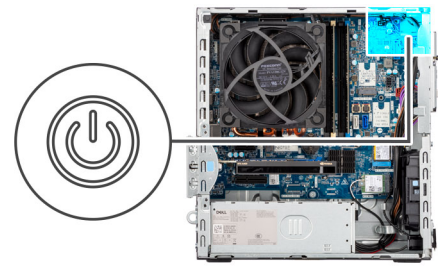

**Figure 46. Installing the power button**

**Steps**

1. Thread the power-button module cable through the slot on the front of the chassis.
2. Align the tabs on the side of the power button with the cutouts on the slot in the chassis.
3. Press the power-button module into its slot on the chassis.
4. Connect the power-button cable to its connector (PWR SW) on the system board.
5. Route the processor-power cable through the routing guide on the chassis.

**Next steps**

1. Install the [drive-bay](#).
2. Install the [front cover](#).
3. Install the [side cover](#).
4. Follow the procedure in [after working inside your computer](#).



# Fan

## Removing the chassis fan

**CAUTION:** The information in this section is intended for authorized service technicians only.

### Prerequisites

1. Follow the procedure in [Before working inside your computer](#).
2. Remove the [side cover](#).
3. Remove the [front bezel](#).
4. Remove the [3.5-inch hard drive](#), if applicable.
5. Remove the [optical drive](#), if applicable.
6. Remove the [drive bay](#).

### About this task

The following images indicate the location of the chassis fan and provide a visual representation of the removal procedure.

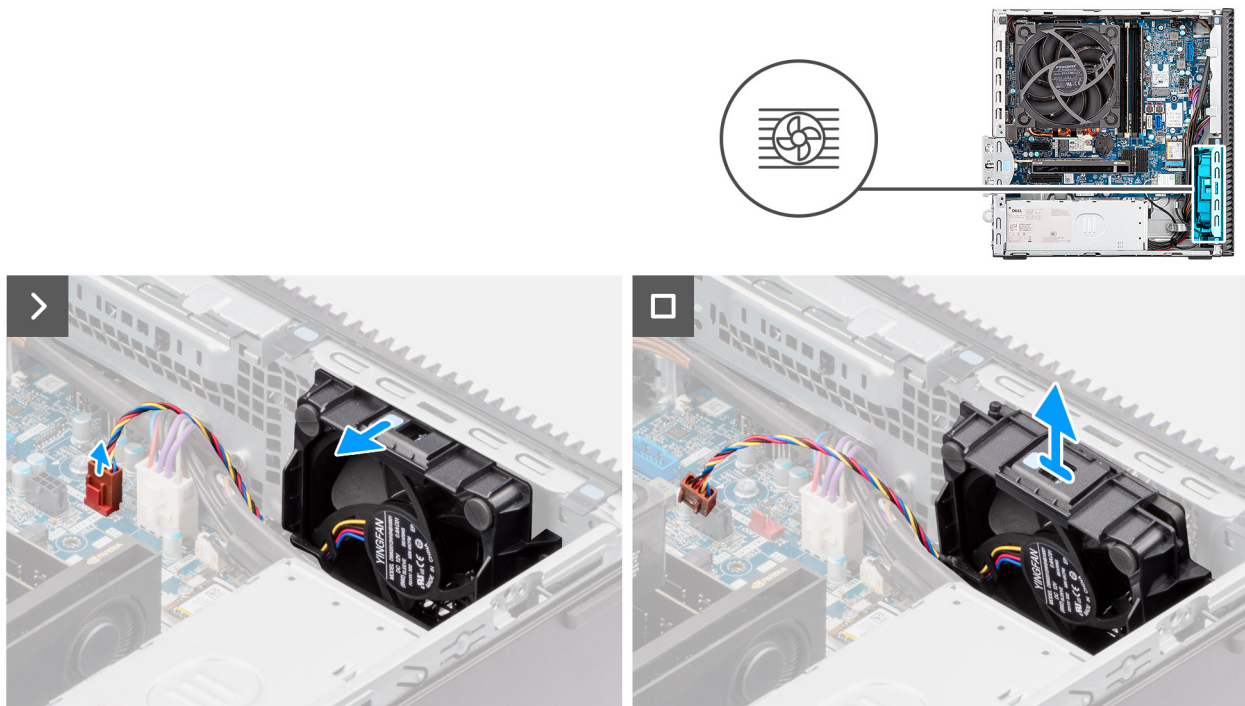

**Figure 47. Removing the chassis fan**

### Steps

1. Disconnect the chassis-fan cable from its connector (FAN SYS 1) on the system board.
2. Press the release latch to release the chassis fan from the chassis.
3. Remove the chassis fan off the chassis.

## Installing the chassis fan

**CAUTION:** The information in this section is intended for authorized service technicians only.

## Prerequisites

If you are replacing a component, remove the existing component before performing the installation procedure.

## About this task

The following images indicate the location of the chassis fan and provide a visual representation of the installation procedure.

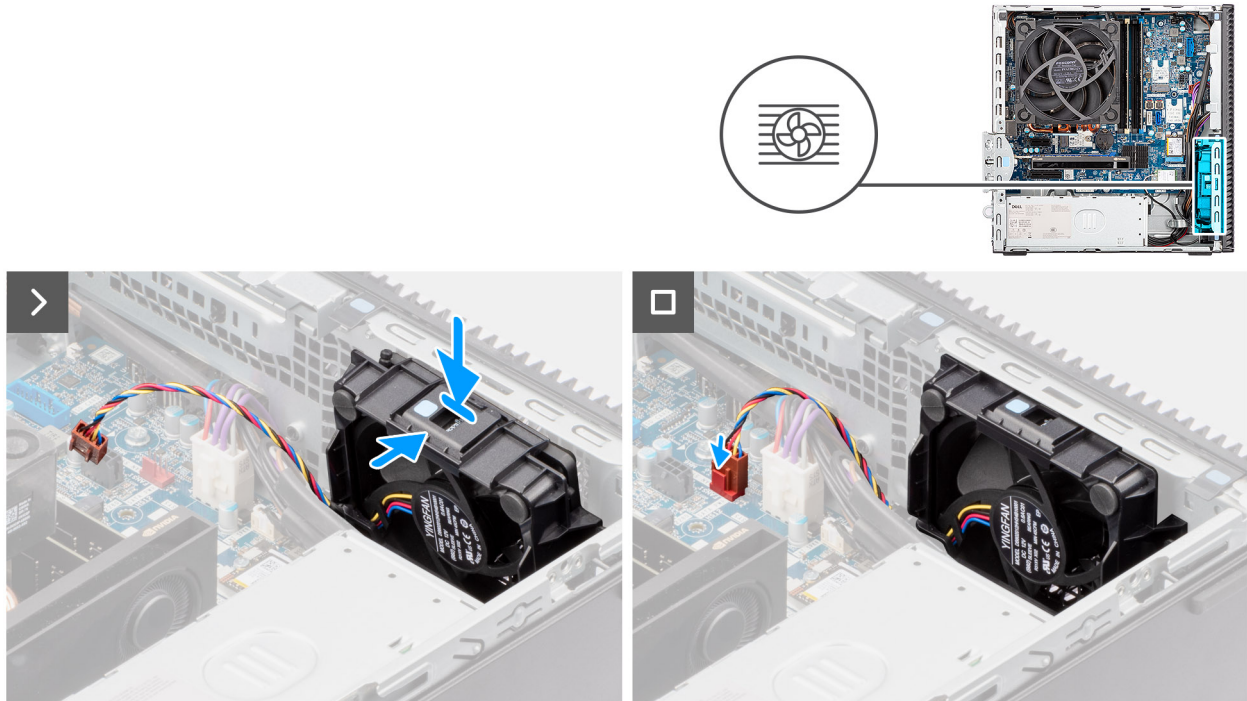

**Figure 48. Installing the chassis fan**

## Steps

1. Align and slide the chassis fan into its slot on the chassis till it clicks in place.
2. Connect the chassis fan cable to its connector (FAN SYS 1) on the system board.

## Next steps

1. Install the [drive bay](#).
2. Install the [optical drive](#), if applicable.
3. Install the [3.5-inch hard drive](#), if applicable.
4. Install the [front bezel](#).
5. Install the [side cover](#).
6. Follow the procedure in [After working inside your computer](#).

# Removing and installing Field Replaceable Units (FRUs)

The replaceable components in this chapter are Field Replaceable Units (FRUs).

 **CAUTION:** The information in this removing and installing FRUs section is intended for authorized service technicians only.

 **CAUTION:** To avoid any potential damage to the component or loss of data, Dell Technologies recommends that an authorized service technician replaces the Field Replaceable Units (FRUs).

 **CAUTION:** Your warranty does not cover damages that may occur during FRU repairs that are not authorized by Dell Technologies.

 **NOTE:** The images in this document may differ from your computer depending on the configuration you ordered.

## Antenna modules

### Removing the antenna module

 **CAUTION:** The information in this section is intended for authorized service technicians only.

#### Prerequisites

1. Follow the procedure in [Before working inside your computer](#).
2. Remove the [side cover](#).
3. Remove the [front cover](#).
4. Remove the [wireless card](#).

#### About this task

The following images indicate the location of the antenna module and provide a visual representation of the removal procedure.



1x  
6-32#

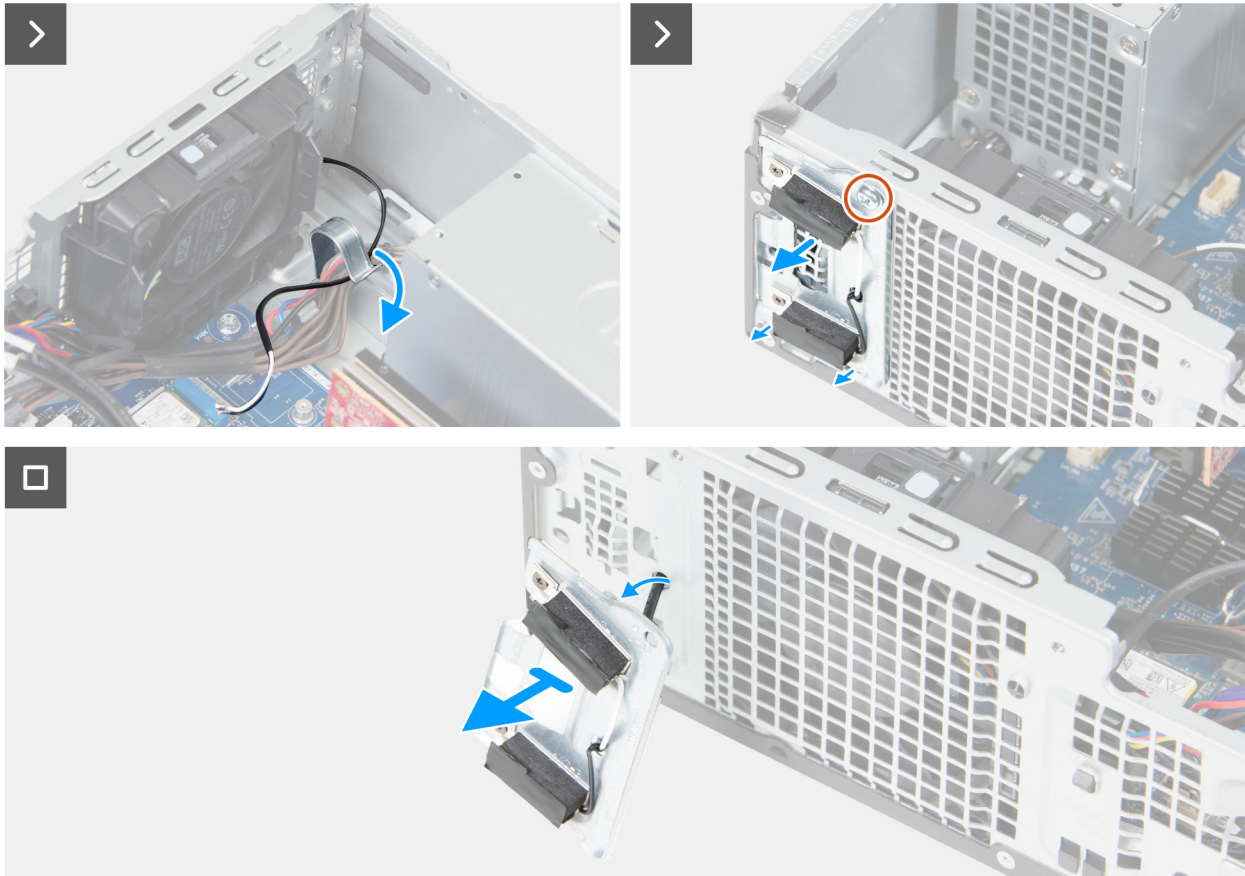

**Figure 49. Removing the antenna module**

### Steps

1. Gently remove the antenna cable from the routing guide on the chassis interior.
2. Remove the screw (6-32#) that secures the antenna module to the chassis.
3. Remove the antenna module from the chassis.

## Installing the antenna module

**CAUTION:** The information in this section is intended for authorized service technicians only.

### Prerequisites

If you are replacing a component, remove the existing component before performing the installation procedure.

### About this task

The following images indicate the location of the antenna module and provide a visual representation of the installation procedure.





1x  
6-32#

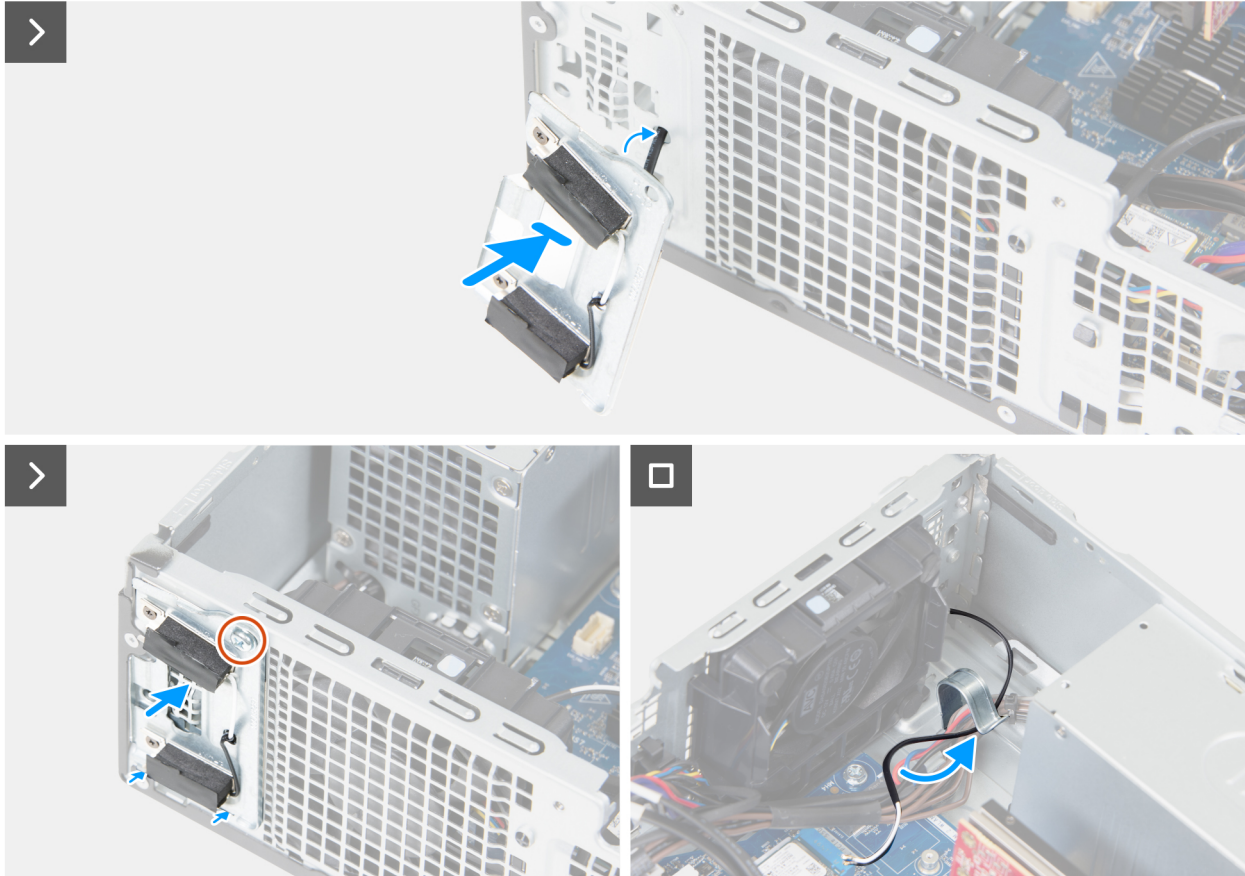

**Figure 50. Installing the antenna module**

### Steps

1. Insert the antenna cables through the slot in the front of the chassis.
2. In an angle slide the tabs on the antenna module into the slot on the chassis.  
**(i) NOTE:** Pull the excess cable slack from the inside of the chassis.
3. Replace the screw (#6-32) that secures the antenna module to the chassis.
4. Route the antenna cable through the routing guide on the chassis.
5. Connect the antenna cables to the wireless card.

### Next steps

1. Install the [wireless card](#).
2. Install the [front bezel](#).
3. Install the [side cover](#).
4. Follow the procedure in [After working inside your computer](#).

# Processor fan and heat-sink assembly

## Removing the processor fan

**CAUTION:** The information in this section is intended for authorized service technicians only.

### Prerequisites

1. Follow the procedure in [Before working inside your computer](#).
2. Remove the [side cover](#).
3. Remove the [front bezel](#).
4. Remove the [3.5-inch hard drive](#), if applicable.
5. Remove the [drive-bay](#).

### About this task

The following images indicate the location of the processor fan and provide a visual representation of the removal procedure.

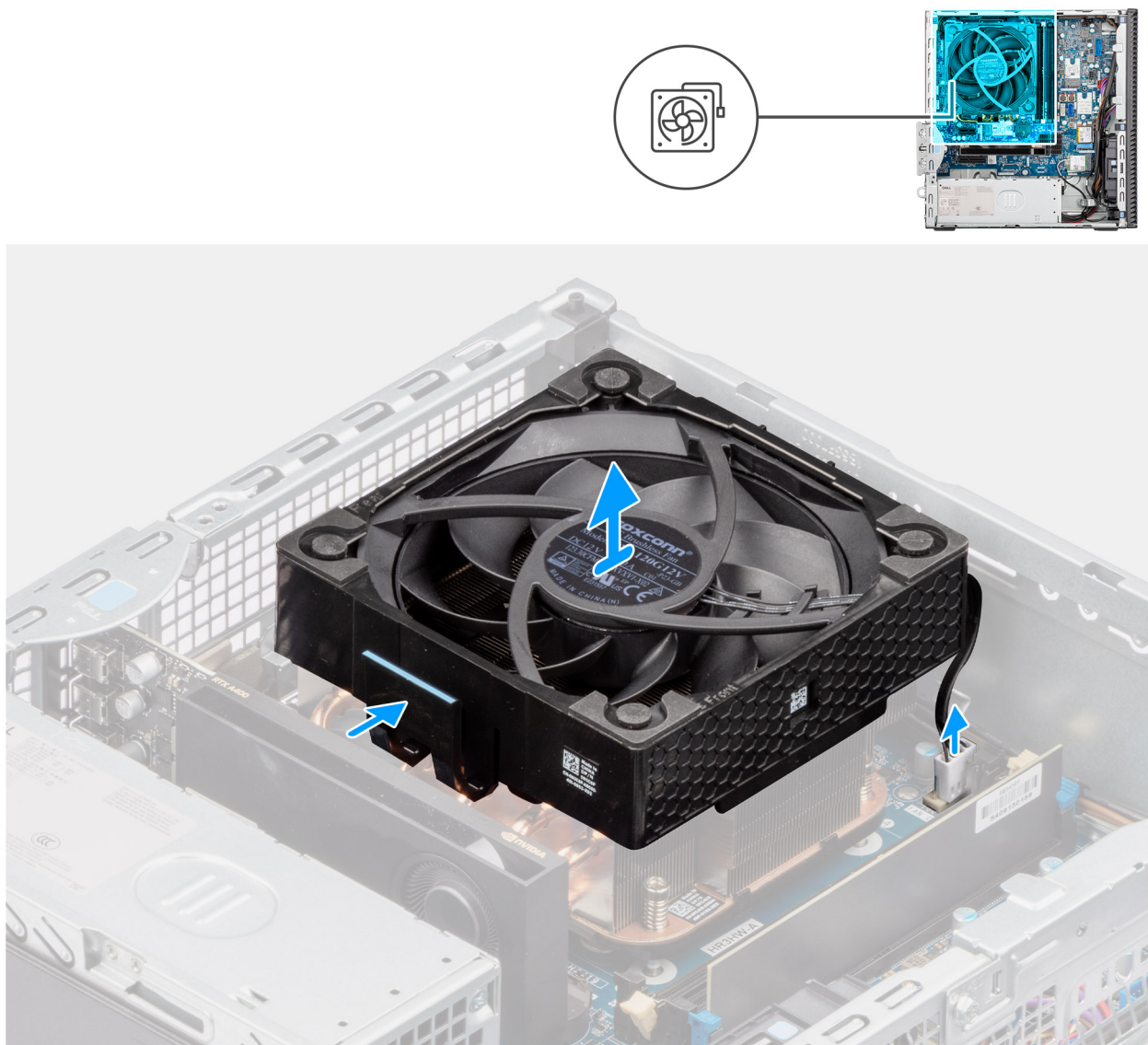

Figure 51. Removing the processor fan

## Steps

1. Disconnect the processor-fan cable from its connector (FAN CPU) on the system board.
2. Press the release tab on the processor fan.
3. Remove the processor fan off the chassis.

## Installing the processor fan

**CAUTION:** The information in this section is intended for authorized service technicians only.

### Prerequisites

If you are replacing a component, remove the existing component before performing the installation procedure.

### About this task

The following images indicate the location of the processor fan and provide a visual representation of the installation procedure.

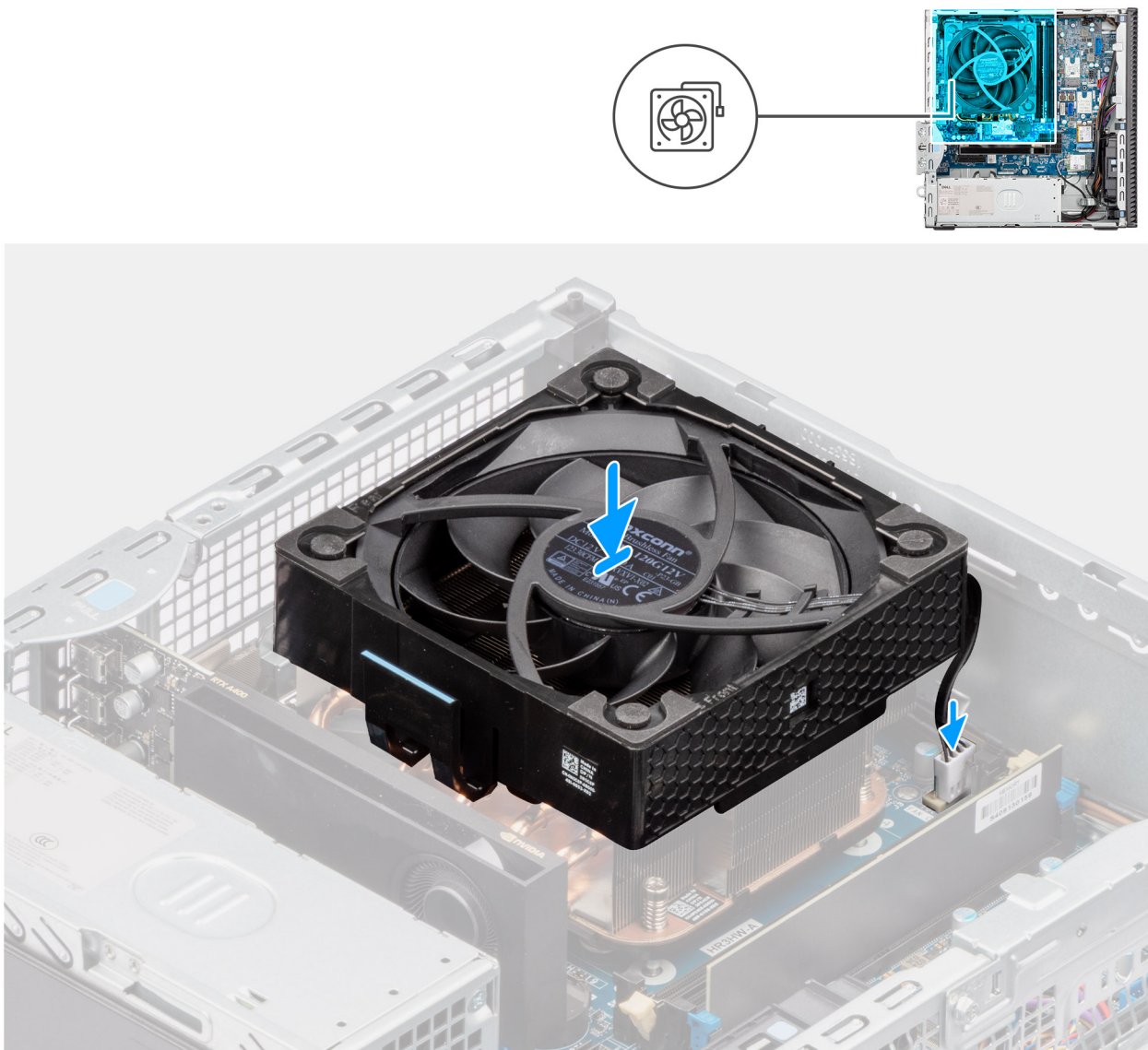

Figure 52. Installing the processor fan



### Steps

1. Place the processor fan on the heat-sink assembly.
2. Press the processor fan down till it clicks into place.
3. Connect the processor fan cable to its connector (FAN CPU) on the system board.

### Next steps

1. Install the [drive-bay](#).
2. Install the [3.5-inch hard drive](#), if applicable.
3. Install the [front bezel](#).
4. Install the [side cover](#).
5. Follow the procedure in [After working inside your computer](#).

## Removing the processor heat-sink assembly

 **CAUTION:** The information in this section is intended for authorized service technicians only.

### Prerequisites

1. Follow the procedure in [Before working inside your computer](#).
2. Remove the [side cover](#).
3. Remove the [drive-bay](#).

### About this task

The following images indicate the location of the processor heat-sink assembly and provide a visual representation of the removal procedure.

 **CAUTION:** For maximum cooling of the processor, do not touch the heat-transfer areas on the heat sink. The oils in your skin can reduce the heat-transfer capability of the thermal grease.

 **NOTE:** The heat sink may become hot during normal operation. Allow sufficient time for the heat sink to cool before touching it.



4x

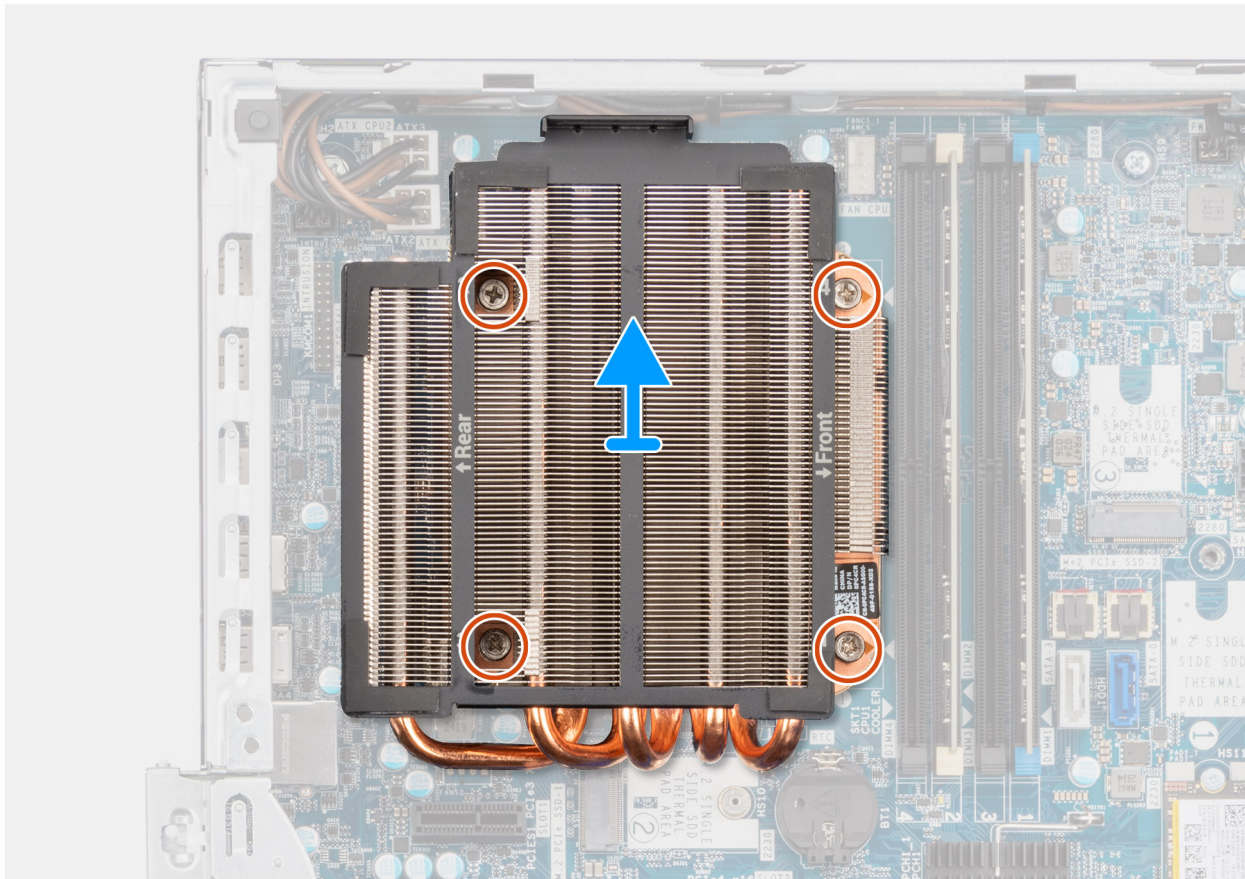
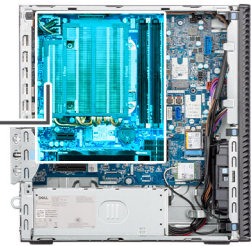

**Figure 53. Removing the processor heat-sink assembly**

### Steps

1. In the reverse sequential order (4, 3, 2, 1 marked on the system board), loosen the four captive screws that secure the processor fan and heat-sink assembly to the system board.
2. Lift the processor heat-sink assembly off the system board.

## Installing the processor heat-sink assembly

**CAUTION:** The information in this section is intended for authorized service technicians only.

### Prerequisites

If you are replacing a component, remove the existing component before performing the installation procedure.

### About this task

The following image indicates the location of the processor fan and heat-sink assembly and provides a visual representation of the installation procedure.

**NOTE:** If either the processor or the fan and heat-sink assembly is replaced, use the thermal grease that is provided in the kit for thermal conductivity.

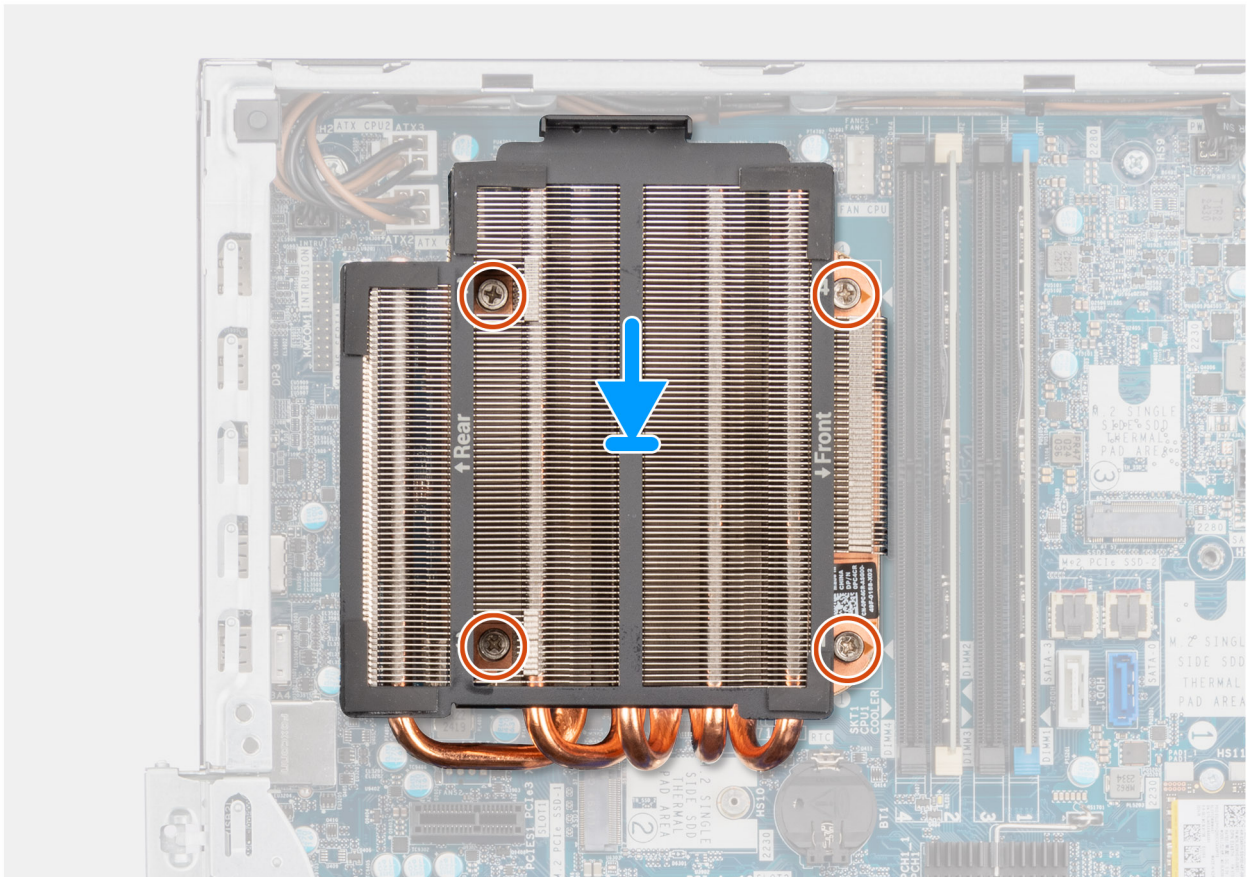

**Figure 54. Installing the processor heat-sink assembly**

### Steps

1. Place the processor heat-sink assembly on the system board and align the captive screws to the screw holes on the system board.
2. In sequential order (1, 2, 3, 4 marked on the system board), tighten the four captive screws that secure the processor fan and heat sink assembly to the system board.

### Next steps

1. Install the [drive-bay](#).
2. Install the [side cover](#).
3. Follow the procedure in [After working inside your computer](#).



# Processor

## Removing the processor

**CAUTION:** The information in this section is intended for authorized service technicians only.

### Prerequisites

1. Follow the procedure in [Before working inside your computer](#).
2. Remove the [side cover](#).
3. Remove the [front cover](#).
4. Remove the [drive-bay](#).
5. Remove the [processor fan](#).
6. Remove the [processor heat-sink assembly](#).

### About this task

The following images indicate the location of the processor and provide a visual representation of the removal procedure.

**WARNING:** The processor might still be hot after the computer is shut down. Allow the processor to cool down before removing it.

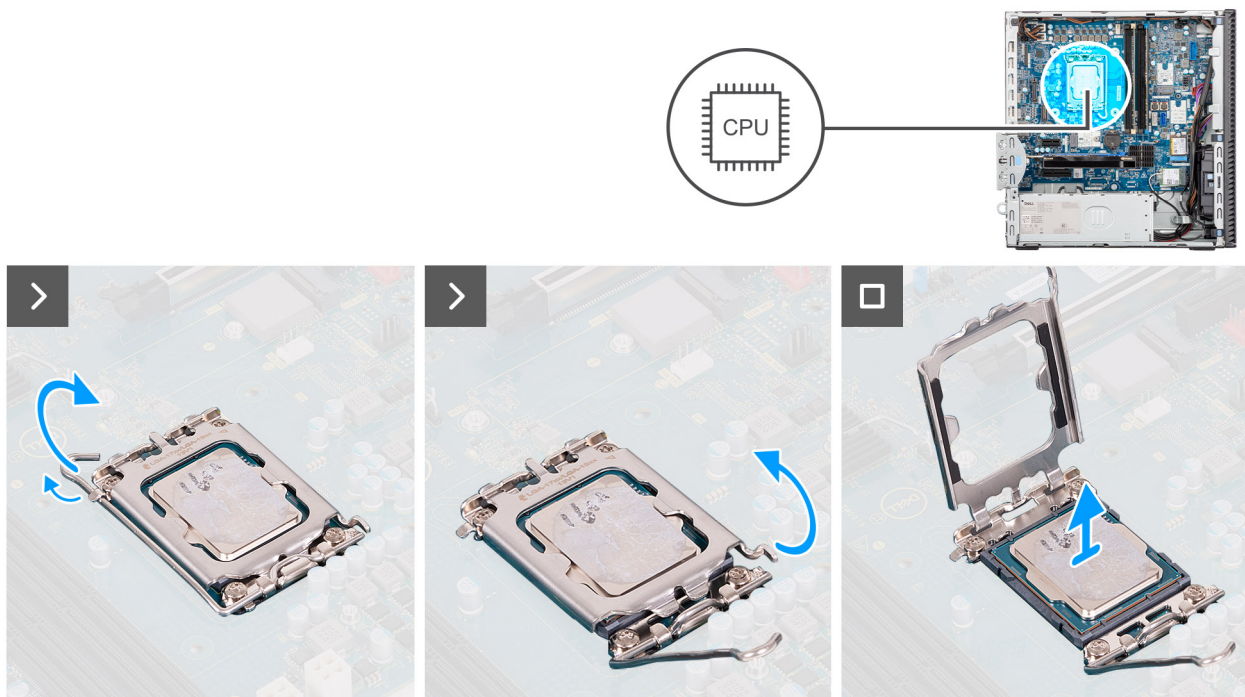

Figure 55. Removing the processor

### Steps

1. Press the release lever down and then push it away from the processor to release it from the securing tab.
2. Extend the release lever completely and open the processor cover.

**CAUTION:** When removing the processor, do not touch any of the pins inside the socket or allow any objects to fall on the pins in the socket.

3. Gently lift the processor from the processor socket.

# Installing the processor

**CAUTION:** The information in this section is intended for authorized service technicians only.

## Prerequisites

If you are replacing a component, remove the existing component before performing the installation procedure.

## About this task

The following images indicate the location of the processor and provide a visual representation of the installation procedure.

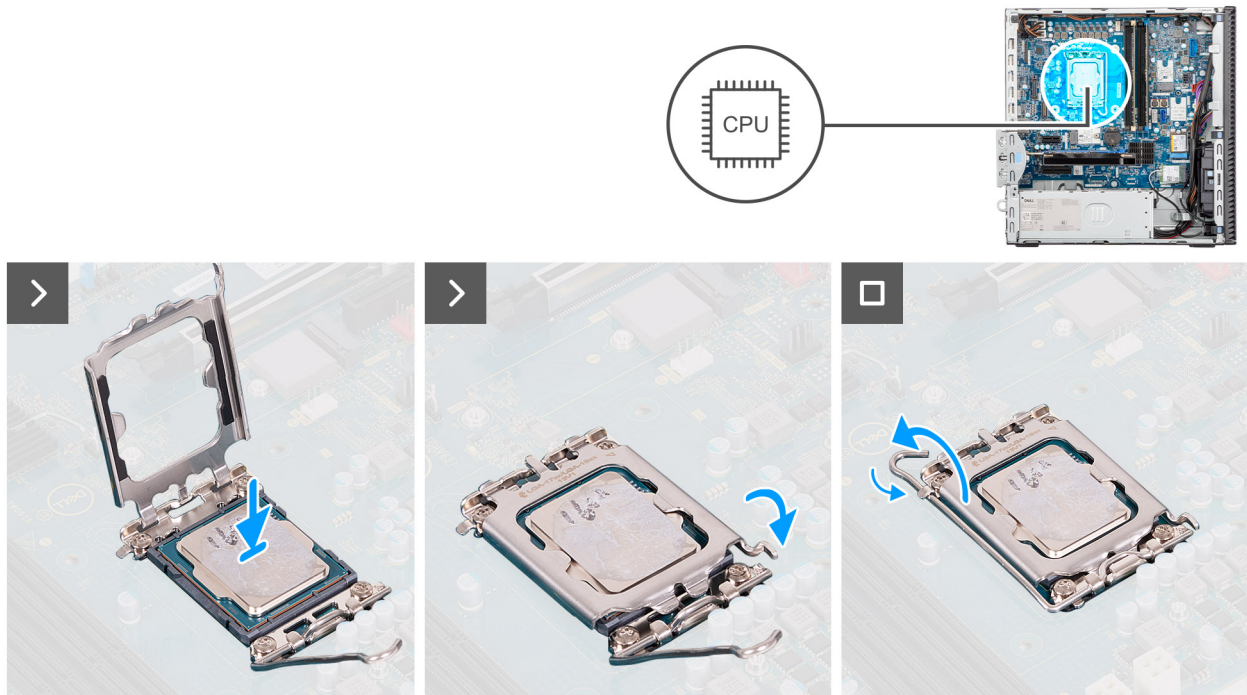

**Figure 56. Installing the processor**

## Steps

1. Ensure that the release lever on the processor socket is fully extended in the open position.

**NOTE:** The pin 1 corner of the processor has a triangle that aligns with the triangle on the pin 1 corner on the processor socket. When the processor is properly seated, all four corners are aligned at the same height. If one or more corners of the processor are higher than the others, the processor is not seated properly.

2. Align the notches on the processor with the tabs on the processor socket and place the processor in the processor socket.

**CAUTION:** Ensure that the processor-cover notch is positioned underneath the alignment post.

3. When the processor is fully seated in the socket, pivot the release-lever down and place it under the tab on the processor cover.

## Next steps

1. Install the [processor heat-sink assembly](#).
2. Install the [processor fan](#)
3. Install the [drive-bay](#).
4. Install the [front cover](#).
5. Install the [side cover](#).
6. Follow the procedure in [After working inside your computer](#).

# Power-supply unit

## Removing the power-supply unit

**CAUTION:** The information in this section is intended for authorized service technicians only.

### Prerequisites

1. Follow the procedure in [Before working inside your computer](#).
2. Remove the [side cover](#).
3. Remove the [front cover](#).
4. Remove the [drive bay](#).
5. Remove the [processor fan](#).
6. Removing the [processor heat-sink assembly](#).

### About this task

The following images indicate the location of the power-supply unit and provide a visual representation of the removal procedure.

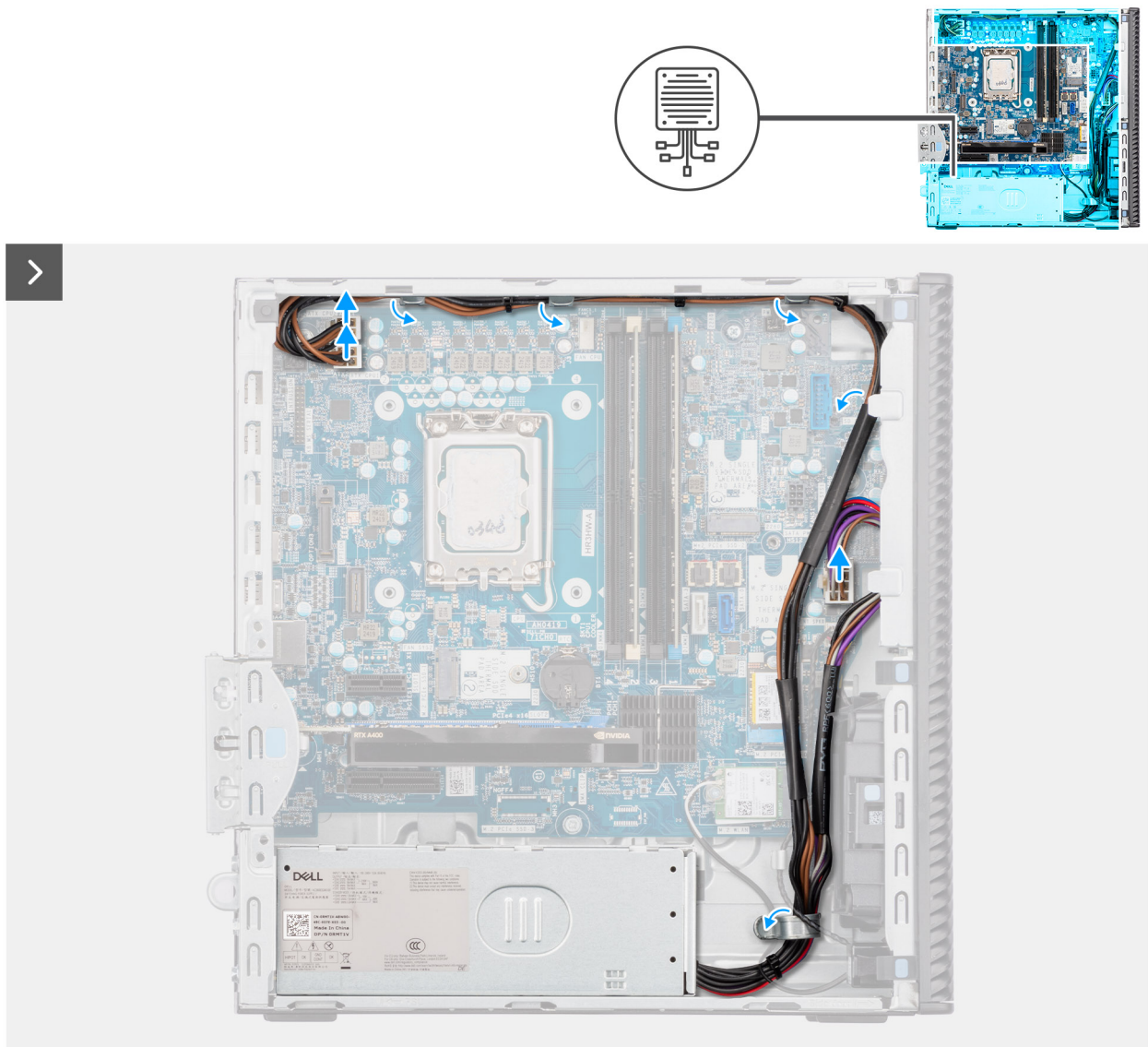
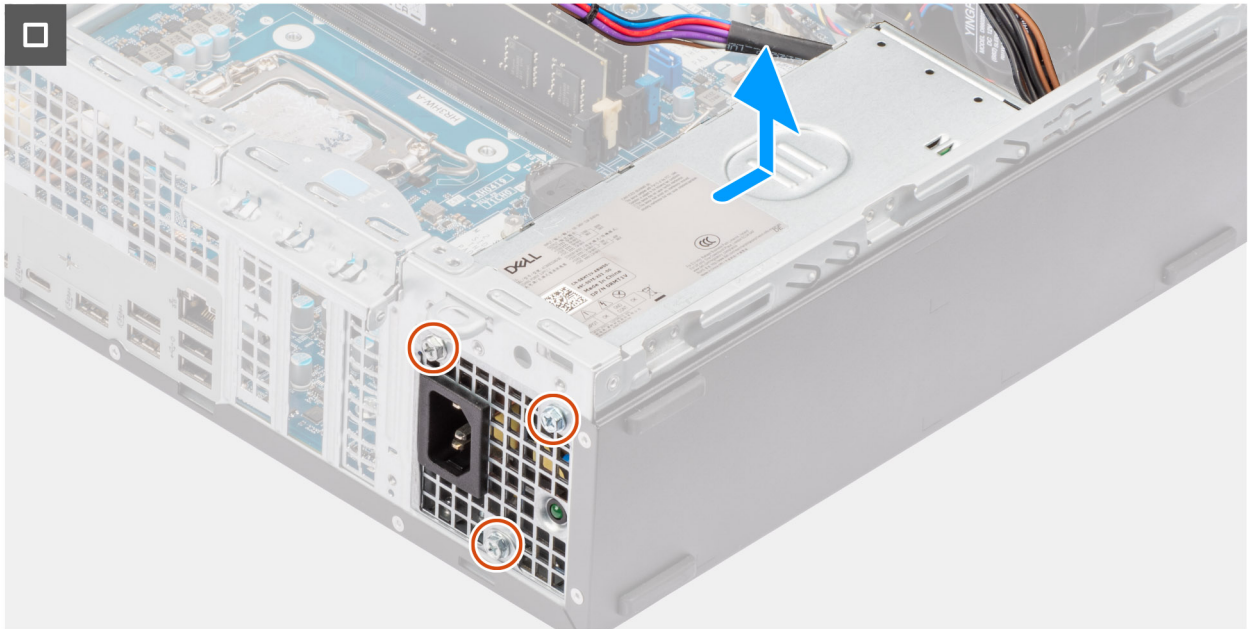

Figure 57. Installing the power-supply unit



**3x**  
6-32#



**Figure 58. Installing the power-supply unit**

### Steps

1. Disconnect the power-supply cables from their connectors (ATX CPU1, ATX CPU2, and ATX SYS) on the system board.
2. Remove the power-supply cables from the routing guides on the chassis.
3. Remove the three screws (6-32#) that secure the power-supply unit to the chassis.
4. Slide and lift the power-supply unit off the chassis.

## Installing the power-supply unit

 **CAUTION:** The information in this section is intended for authorized service technicians only.

### Prerequisites

If you are replacing a component, remove the existing component before performing the installation procedure.

### About this task

The following images indicate the location of the power-supply unit and provide a visual representation of the installation procedure.





**3x**  
6-32#

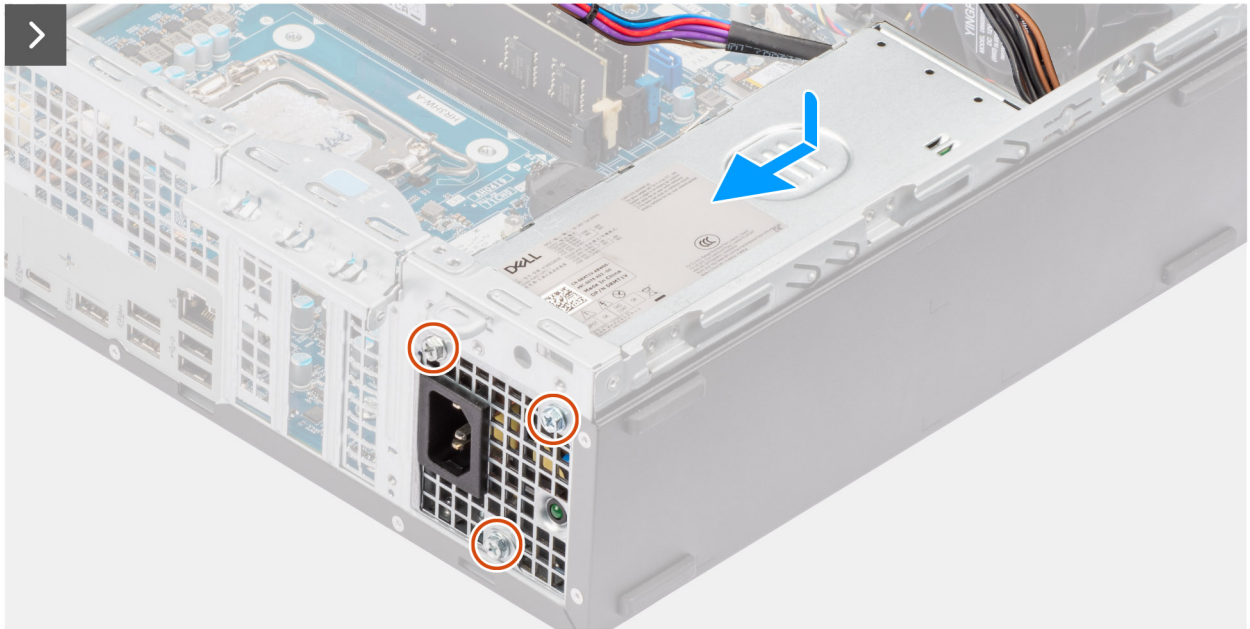

**Figure 59. Installing the power-supply unit**

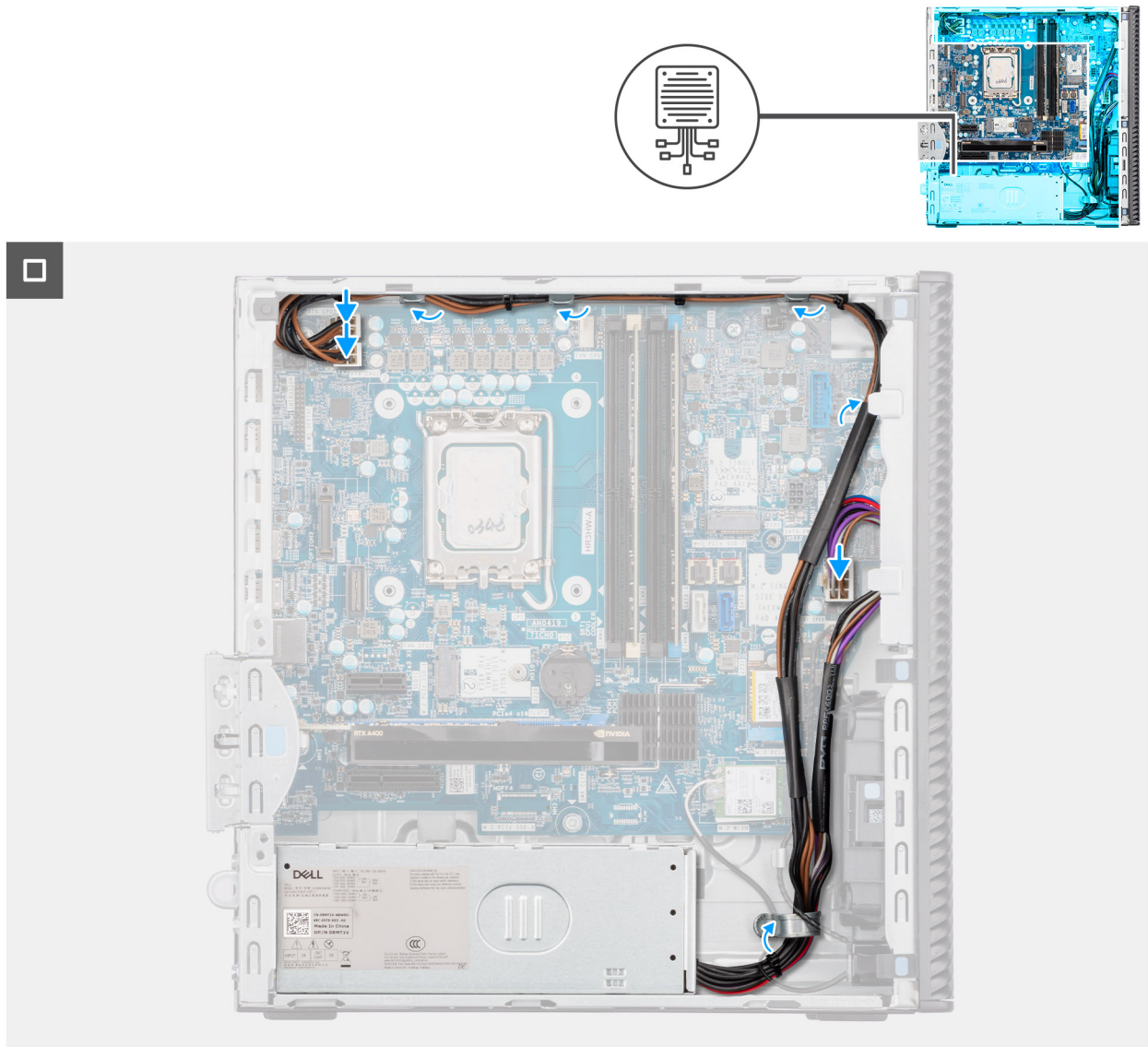

**Figure 60. Installing the power-supply unit**

**Steps**

1. Place the power-supply unit on the chassis and slide it towards the back of the chassis.
2. Replace the three screws (6-32#) that secure the power-supply unit to the chassis.
3. Route the power-supply cables through their routing guides on the chassis.
4. Connect the power-supply cables to their connectors (ATX CPU1, ATX CPU2, and ATX SYS) on the system board.

**Next steps**

1. Install the [processor heat-sink assembly](#).
2. Install the [processor fan](#).
3. Install the [drive-bay](#).
4. Install the [front cover](#).
5. Install the [side cover](#).
6. Follow the procedure in [After working inside your computer](#).

# External port (optional module)

**NOTE:** For more information about the ports supported by the external port (optional module slot), see [Specifications](#).

## Removing the optional VGA module

### Prerequisites

1. Follow the procedure in [before working inside your computer](#).
2. Remove the [side cover](#).
3. Remove the [front cover](#).
4. Remove the [3.5-inch hard drive](#).
5. Remove the [drive-bay](#).
6. Remove the [processor fan](#).
7. Remove the [processor heat-sink assembly](#).

### About this task

The following image indicates the location of the optional VGA module and provides a visual representation of the removal procedure.



**Figure 61. Removing the optional VGA module**

### Steps

1. Remove the screw (M2x4) that secures the optional VGA module cover to the optional VGA module.
2. Remove the screw (M2x4) that secures the optional VGA module to the system board.
3. Lift the optional VGA module at an angle and remove the tabs on the optional VGA module from the slots on the chassis.
4. Remove the optional VGA module off the system board.

# Installing the optional VGA module

## Prerequisites

If you are replacing a component, remove the existing component before performing the installation process.

## About this task

- NOTE:** The optional-port modules are mutually exclusive; only a single module can be installed at a time.
- NOTE:** Ensure to reapply thermal grease when installing the processor heat sink after an optional module installation to maintain optimal functionality.

The following images indicate the location of the optional VGA module and provide a visual representation of the installation procedure.

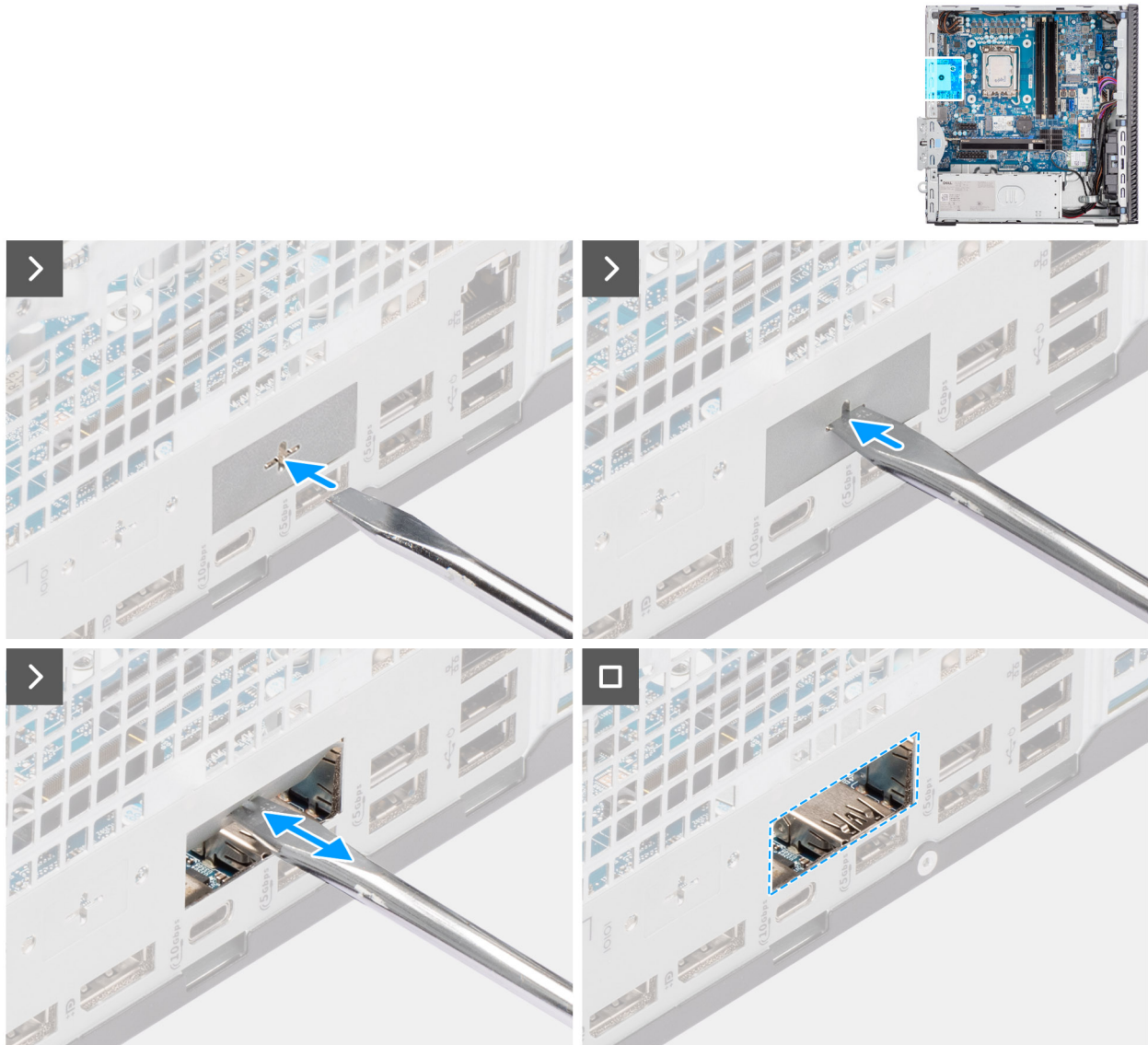
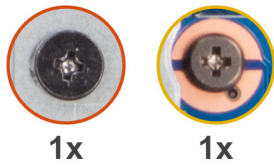

Figure 62. Installing the optional VGA module





**Figure 63. Installing the optional VGA module**

### Steps

1. Using a screw driver, push against the optional-port cover until it comes off.  
**i** **NOTE:** This step is only applicable if you are installing the optional-port module on a computer that did not previously have it installed.
2. Place the optional VGA module at an angle and align the tabs on the module to the slots on the chassis.
3. Align the optional VGA module to the slot on the chassis and connect the module to the connector on the system board (OPTION).
4. Replace the screw (M2x4) that secures the optional VGA module to the system board.
5. Align the screw on the optional VGA module cover to the screw hole on the optional VGA module.
6. Replace the screw (M2x4) that secures the optional VGA module cover to the optional VGA module.

### Next steps

1. Install the [processor heat-sink assembly](#).
2. Install the [processor fan](#).
3. Install the [drive-bay](#).
4. Install the [3.5-inch hard drive](#).
5. Install the [front cover](#).
6. Install the [side cover](#).
7. Follow the procedure in [after working inside your computer](#).

## Removing the optional USB module

### Prerequisites

1. Follow the procedure in [before working inside your computer](#).
2. Remove the [side cover](#).
3. Remove the [front cover](#).
4. Remove the [3.5-inch hard drive](#).
5. Remove the [drive-bay](#).
6. Remove the [processor fan](#).

7. Remove the [processor heat-sink assembly](#).

### About this task

The following image indicates the location of the optional USB module and provides a visual representation of the removal procedure.

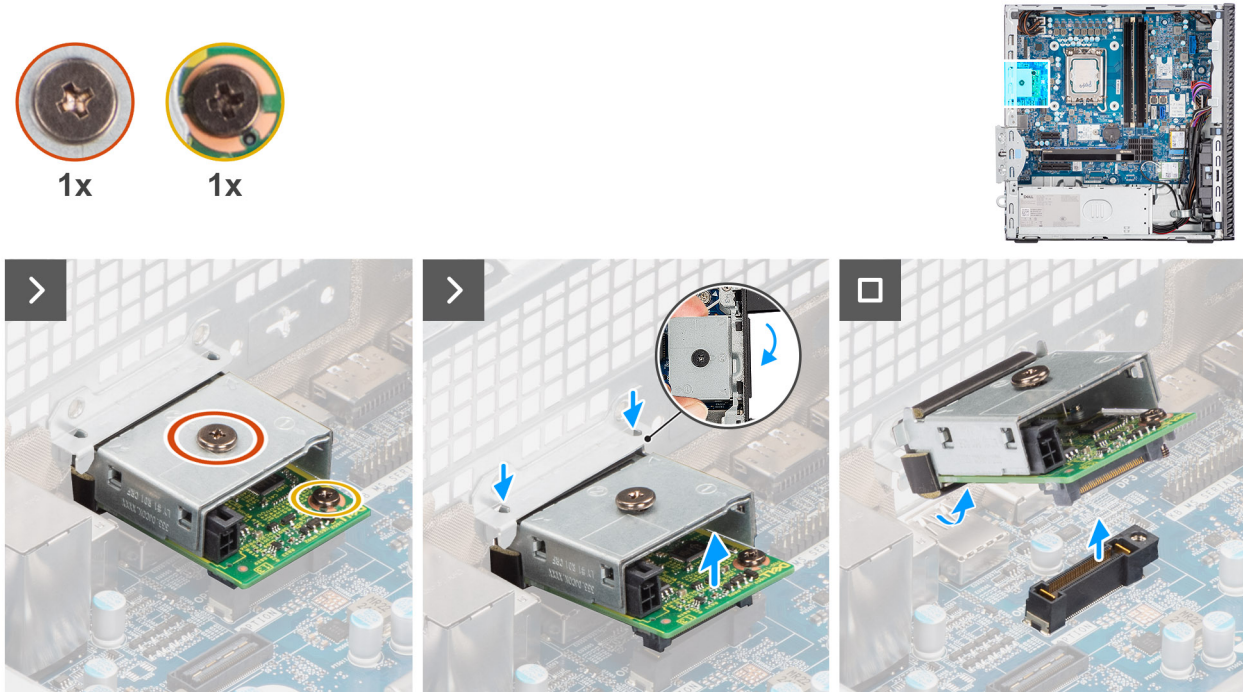

**Figure 64. Removing the optional USB module**

### Steps

1. Remove the screw (M2x4) that secures the optional USB module cover to the optional USB module.
2. Remove the screw (M2x4) that secures the optional USB module to the system board.
3. Lift the optional USB module at an angle and remove the tabs on the optional USB module from the slots on the chassis.
4. Remove the optional USB module off the system board.

## Installing the optional USB module

### Prerequisites

If you are replacing a component, remove the existing component before performing the installation process.

### About this task

- NOTE:** The optional-port modules are mutually exclusive; only a single module can be installed at a time.
- NOTE:** Ensure to reapply thermal grease when installing the processor heat sink after an optional module installation to maintain optimal functionality.

The following images indicate the location of the optional USB module and provide a visual representation of the installation procedure.

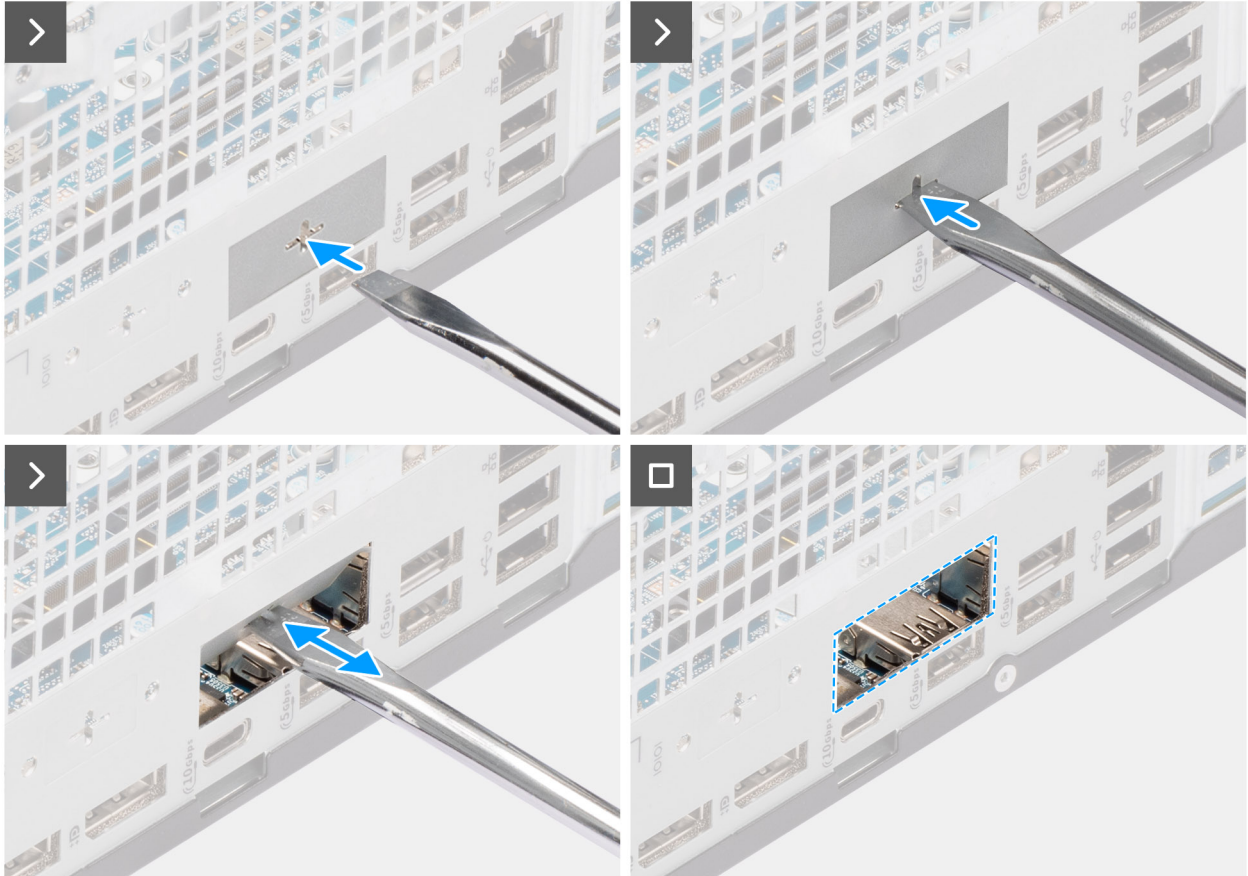
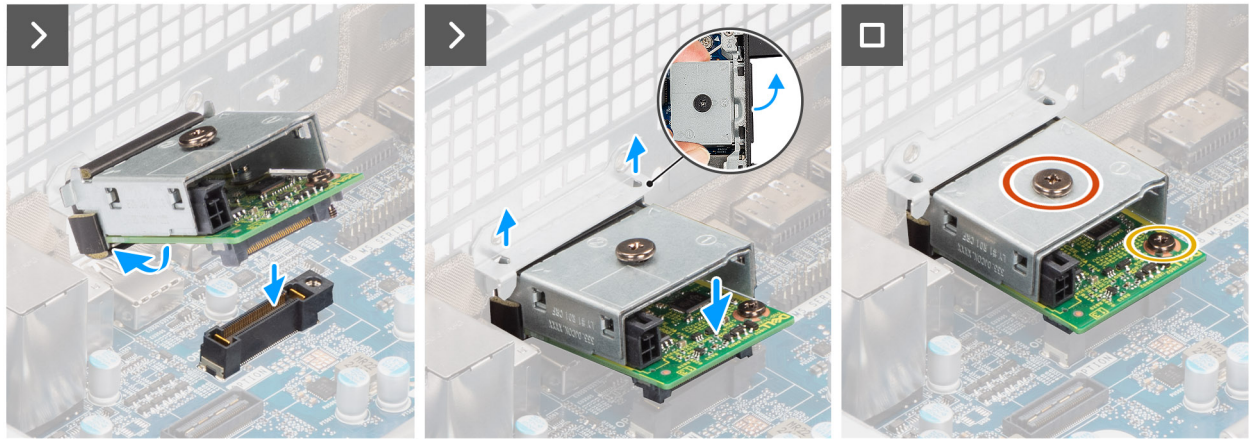
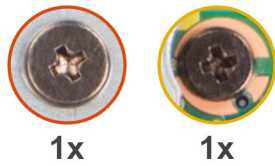

Figure 65. Installing the optional USB module





**Figure 66. Installing the optional USB module**

### Steps

1. Using a screw driver, push against the optional-port cover until it comes off.  
**i** **NOTE:** This step is only applicable if you are installing the optional-port module on a computer that did not previously have it installed.
2. Place the optional USB module at an angle and align the tabs on the module to the slots on the chassis.
3. Align the optional USB module to the slot on the chassis and connect the module to the connector on the system board (OPTION).
4. Replace the screw (M2x4) that secures the optional USB module to the system board.
5. Align the screw on the optional USB module cover to the screw hole on the optional USB module.
6. Replace the screw (M2x4) that secures the optional USB module cover to the optional USB module.

### Next steps

1. Install the [processor heat-sink assembly](#).
2. Install the [processor fan](#).
3. Install the [drive-bay](#).
4. Install the [3.5-inch hard drive](#).
5. Install the [front cover](#).
6. Install the [side cover](#).
7. Follow the procedure in [after working inside your computer](#).

## Removing the optional Thunderbolt module

### Prerequisites

1. Follow the procedure in [before working inside your computer](#).
2. Remove the [side cover](#).
3. Remove the [front cover](#).
4. Remove the [3.5-inch hard drive](#).
5. Remove the [drive-bay](#).
6. Remove the [processor fan](#).

7. Remove the [processor heat-sink assembly](#).

### About this task

The following image indicates the location of the optional Thunderbolt module and provides a visual representation of the removal procedure.

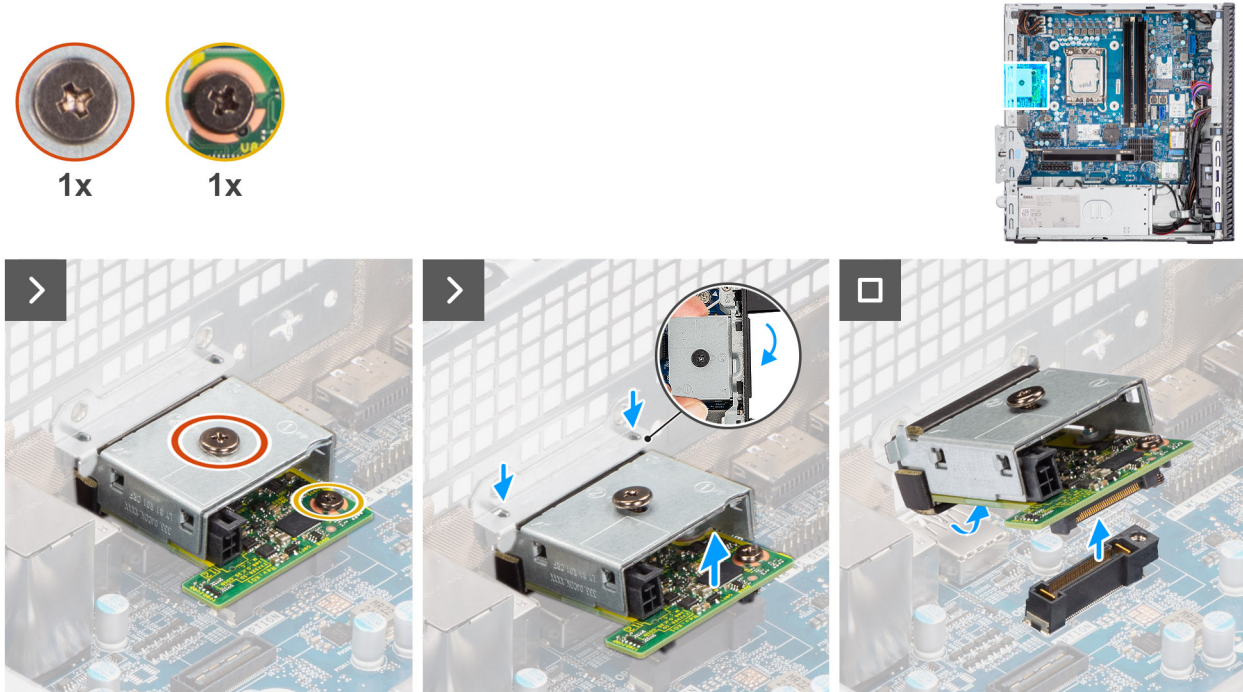

**Figure 67. Removing the optional Thunderbolt module**

### Steps

1. Remove the screw (M2x4) that secures the optional Thunderbolt module cover to the optional Thunderbolt module.
2. Remove the screw (M2x4) that secures the optional Thunderbolt module to the system board.
3. Lift the optional Thunderbolt module at an angle and remove the tabs on the optional Thunderbolt module from the slots on the chassis.
4. Remove the optional Thunderbolt module off the system board.

## Installing the optional Thunderbolt module

### Prerequisites

If you are replacing a component, remove the existing component before performing the installation process.

### About this task

- NOTE:** The optional-port modules are mutually exclusive; only a single module can be installed at a time.
- NOTE:** Ensure to reapply thermal grease when installing the processor heat sink after an optional module installation to maintain optimal functionality.

The following images indicate the location of the optional Thunderbolt module and provide a visual representation of the installation procedure.

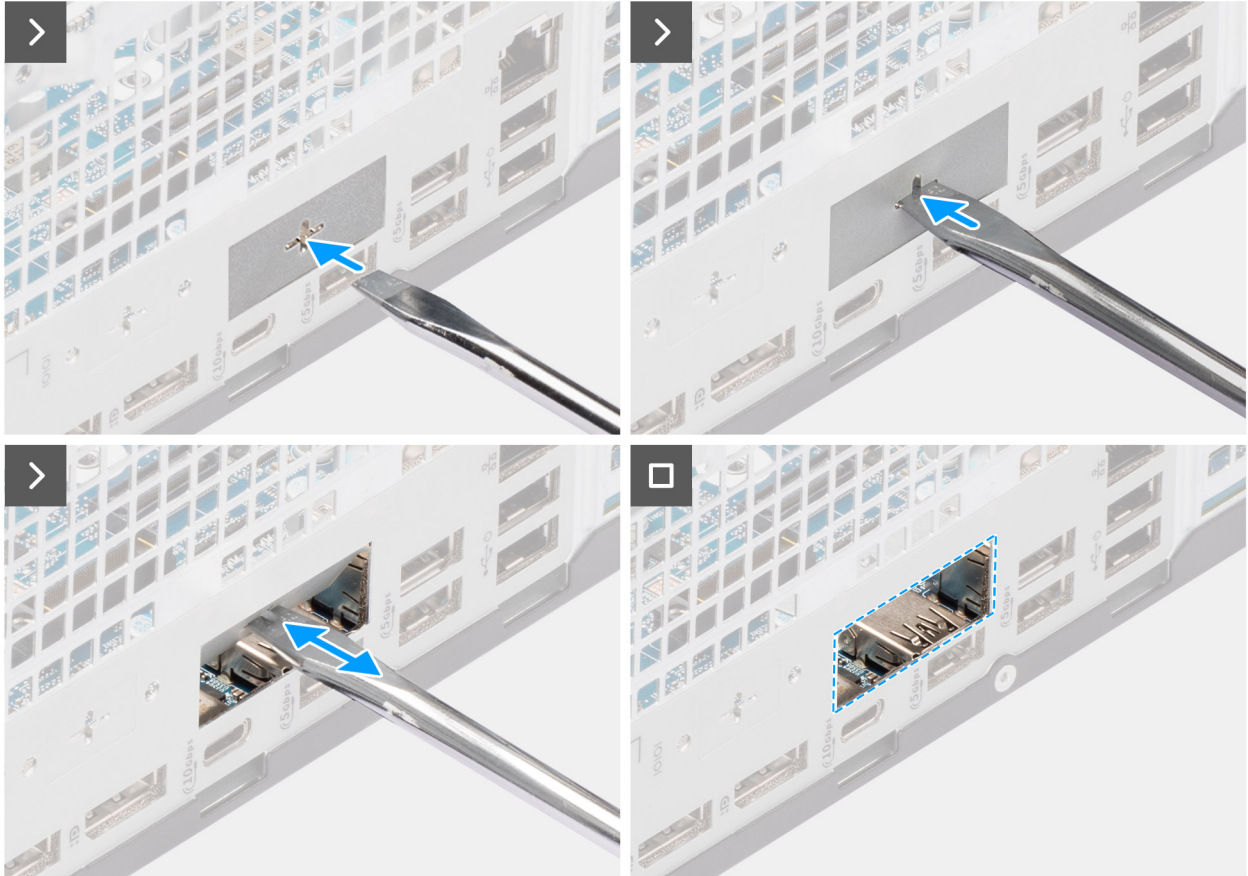
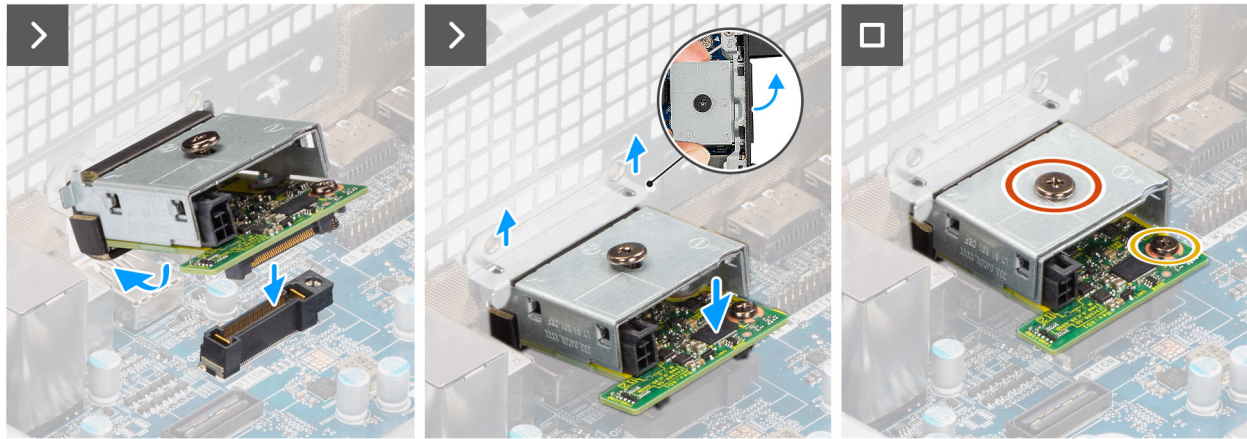

Figure 68. Installing the optional Thunderbolt module





**Figure 69. Installing the optional Thunderbolt module**

### Steps

1. Using a screw driver, push against the optional-port cover until it comes off.  
**NOTE:** This step is only applicable if you are installing the optional-port module on a computer that did not previously have it installed.
2. Place the optional Thunderbolt module at an angle and align the tabs on the module to the slots on the chassis.
3. Align the optional Thunderbolt module to the slot on the chassis and connect the module to the connector on the system board (OPTION).
4. Replace the screw (M2x4) that secures the optional Thunderbolt module to the system board.
5. Align the screw on the optional Thunderbolt module cover to the screw hole on the optional Thunderbolt module.
6. Replace the screw (M2x4) that secures the optional Thunderbolt module cover to the optional Thunderbolt module.

### Next steps

1. Install the [processor heat-sink assembly](#).
2. Install the [processor fan](#).
3. Install the [drive-bay](#).
4. Install the [3.5-inch hard drive](#).
5. Install the [front cover](#).
6. Install the [side cover](#).
7. Follow the procedure in [after working inside your computer](#).

## Removing the optional LAN module

### Prerequisites

1. Follow the procedure in [before working inside your computer](#).
2. Remove the [side cover](#).
3. Remove the [front cover](#).
4. Remove the [3.5-inch hard drive](#).
5. Remove the [drive-bay](#).
6. Remove the [processor fan](#).

7. Remove the [processor heat-sink assembly](#).

**About this task**

The following image indicates the location of the optional LAN module and provides a visual representation of the removal procedure.



**Figure 70. Removing the optional LAN module**

**Steps**

1. Remove the screw (M2x4) that secures the optional LAN module cover to the optional LAN module.
2. Remove the screw (M2x4) that secures the optional LAN module to the system board.
3. Lift the optional LAN module at an angle and remove the tabs on the optional LAN module from the slots on the chassis.
4. Remove the optional LAN module off the system board.

## Installing the optional LAN module

**Prerequisites**

If you are replacing a component, remove the existing component before performing the installation process.

**About this task**

- NOTE:** The optional-port modules are mutually exclusive; only a single module can be installed at a time.
- NOTE:** Ensure to reapply thermal grease when installing the processor heat sink after an optional module installation to maintain optimal functionality.

The following images indicate the location of the optional LAN module and provide a visual representation of the installation procedure.

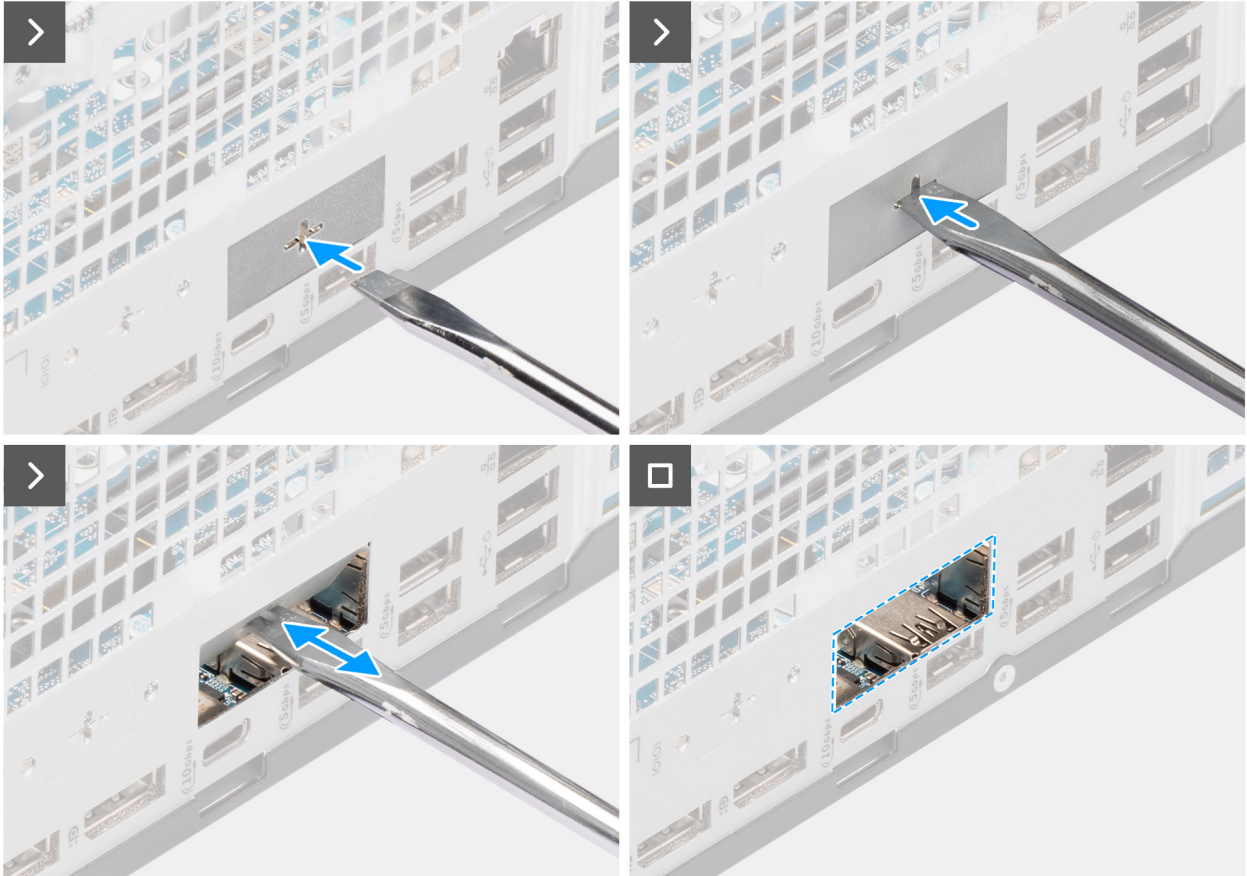

Figure 71. Installing the optional LAN module





**Figure 72. Installing the optional LAN module**

### Steps

1. Using a screw driver, push against the optional-port cover until it comes off.
  - NOTE:** This step is only applicable if you are installing the optional-port module on a computer that did not previously have it installed.
2. Place the optional LAN module at an angle and align the tabs on the module to the slots on the chassis.
3. Align the optional LAN module to the slot on the chassis and connect the module to the connector on the system board (OPTION).
4. Replace the screw (M2x4) that secures the optional LAN module to the system board.
5. Align the screw on the optional LAN module cover to the screw hole on the optional LAN module.
6. Replace the screw (M2x4) that secures the optional LAN module cover to the optional LAN module.

### Next steps

1. Install the [processor heat-sink assembly](#).
2. Install the [processor fan](#).
3. Install the [drive-bay](#).
4. Install the [3.5-inch hard drive](#).
5. Install the [front cover](#).
6. Install the [side cover](#).
7. Follow the procedure in [after working inside your computer](#).

## Removing the optional HDMI module

### Prerequisites

1. Follow the procedure in [before working inside your computer](#).
2. Remove the [side cover](#).
3. Remove the [front cover](#).
4. Remove the [3.5-inch hard drive](#).
5. Remove the [drive-bay](#).
6. Remove the [processor fan](#).

7. Remove the [processor heat-sink assembly](#).

### About this task

The following image indicates the location of the optional HDMI module and provides a visual representation of the removal procedure.



**Figure 73. Removing the optional HDMI module**

### Steps

1. Remove the screw (M2x4) that secures the optional HDMI cover to the optional HDMI module.
2. Remove the screw (M2x4) that secures the optional HDMI module to the system board.
3. Lift the optional HDMI module at an angle and remove the tabs on the optional HDMI module from the slots on the chassis.
4. Remove the optional HDMI module off the system board.

## Installing the optional HDMI module

### Prerequisites

If you are replacing a component, remove the existing component before performing the installation process.

### About this task

**NOTE:** The optional-port modules are mutually exclusive; only a single module can be installed at a time.

**NOTE:** Ensure to reapply thermal grease when installing the processor heat sink after an optional module installation to maintain optimal functionality.

The following images indicate the location of the optional HDMI module and provide a visual representation of the installation procedure.

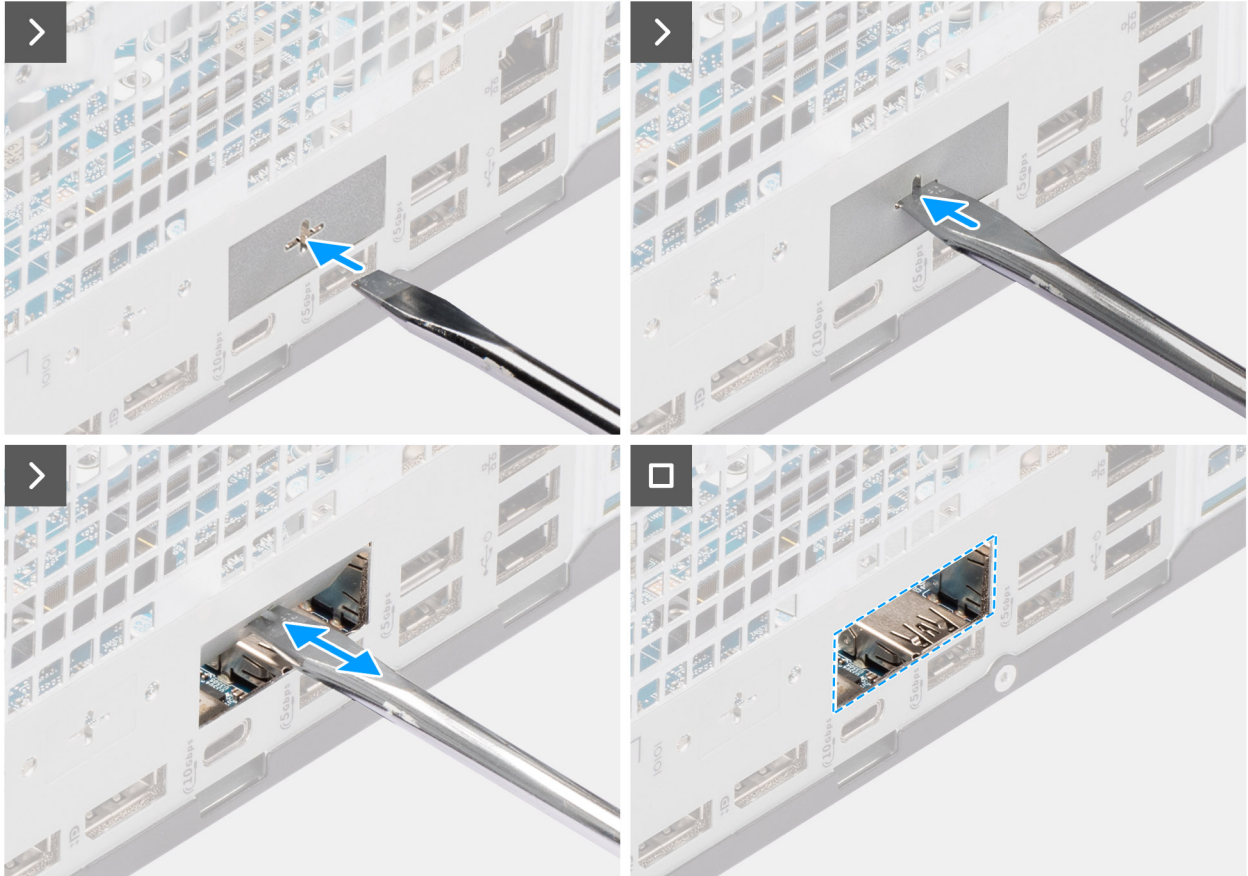
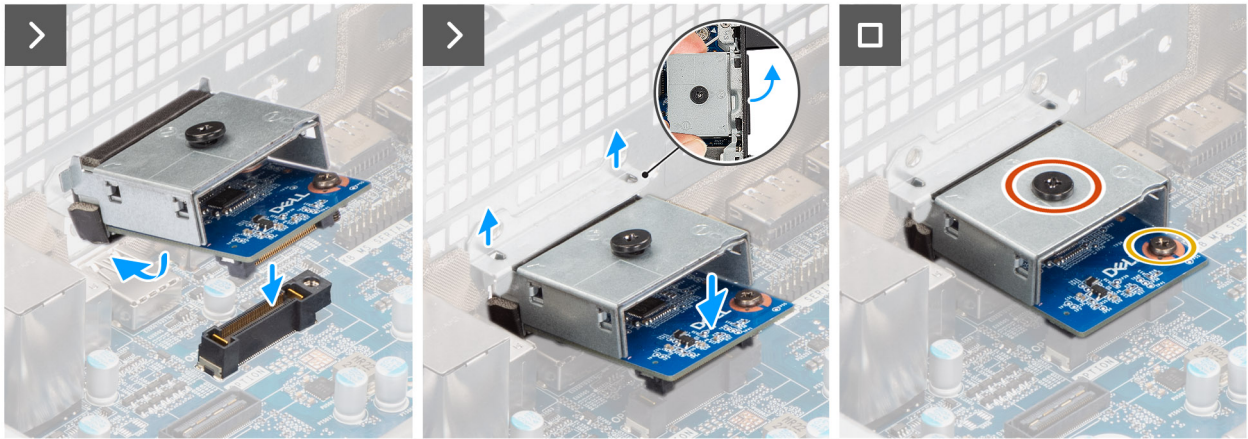
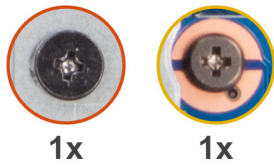

Figure 74. Installing the optional HDMI module





**Figure 75. Installing the optional HDMI module**

### Steps

1. Using a screw driver, push against the optional-port cover until it comes off.  
**NOTE:** This step is only applicable if you are installing the optional-port module on a computer that did not previously have it installed.
2. Place the optional HDMI module at an angle and align the tabs on the module to the slots on the chassis.
3. Align the optional HDMI module to the slot on the chassis and connect the module to the connector on the system board (OPTION).
4. Replace the screw (M2x4) that secures the optional HDMI module to the system board.
5. Align the screw on the optional HDMI cover to the screw hole on the optional HDMI module.
6. Replace the screw (M2x4) that secures the optional HDMI cover to the optional HDMI module.

### Next steps

1. Install the [processor heat-sink assembly](#).
2. Install the [processor fan](#).
3. Install the [drive-bay](#).
4. Install the [3.5-inch hard drive](#).
5. Install the [front cover](#).
6. Install the [side cover](#).
7. Follow the procedure in [after working inside your computer](#).

## Removing the optional DisplayPort module

### Prerequisites

1. Follow the procedure in [before working inside your computer](#).
2. Remove the [side cover](#).
3. Remove the [front cover](#).
4. Remove the [3.5-inch hard drive](#).
5. Remove the [drive-bay](#).
6. Remove the [processor fan](#).

7. Remove the [processor heat-sink assembly](#).

### About this task

The following image indicates the location of the optional DisplayPort module and provides a visual representation of the removal procedure.



**Figure 76. Removing the optional DisplayPort module**

### Steps

1. Remove the screw (M2x4) that secures the optional DisplayPort cover to the optional DisplayPort module.
2. Remove the screw (M2x4) that secures the optional DisplayPort module to the system board.
3. Lift the optional DisplayPort module at an angle and remove the tabs on the optional DisplayPort module from the slots on the chassis.
4. Remove the optional DisplayPort module off the system board.

## Installing the optional DisplayPort module

### Prerequisites

If you are replacing a component, remove the existing component before performing the installation process.

### About this task

- NOTE:** The optional-port modules are mutually exclusive; only a single module can be installed at a time.
- NOTE:** Ensure to reapply thermal grease when installing the processor heat sink after an optional module installation to maintain optimal functionality.

The following images indicate the location of the optional DisplayPort module and provide a visual representation of the installation procedure.



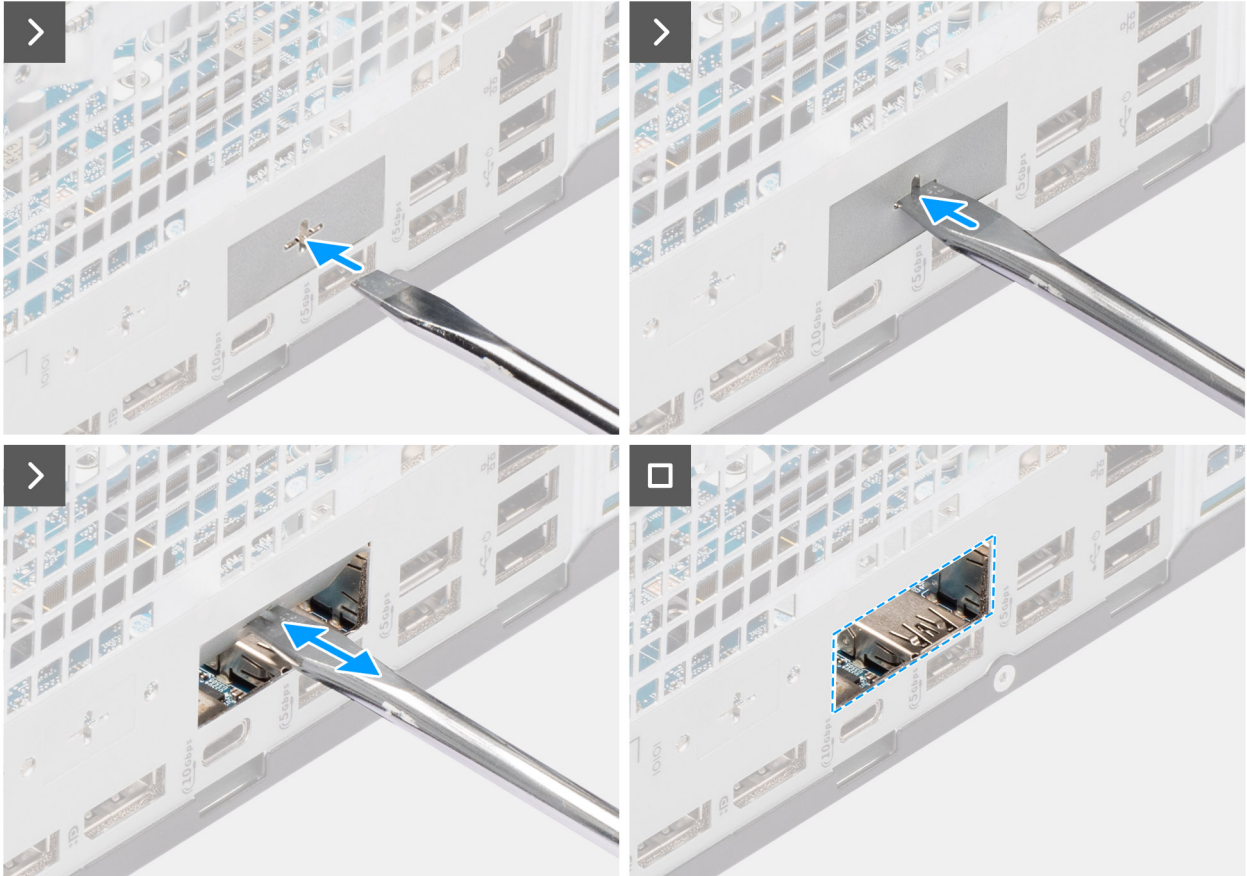
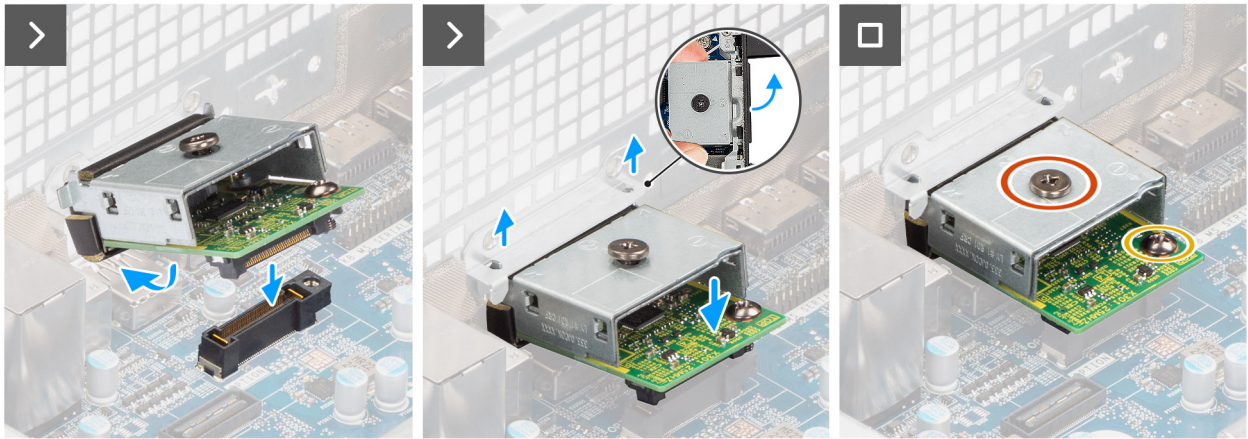

Figure 77. Installing the optional DisplayPort module



**Figure 78. Installing the optional DisplayPort module**

### Steps

1. Using a screw driver, push against the optional-port cover until it comes off.
  - NOTE:** This step is only applicable if you are installing the optional-port module on a computer that did not previously have it installed.
2. Place the optional DisplayPort module at an angle and align the tabs on the module to the slots on the chassis.
3. Align the optional DisplayPort module to the slot on the chassis and connect the module to the connector on the system board (OPTION).
4. Replace the screw (M2x4) that secures the optional DisplayPort module to the system board.
5. Align the screw on the optional DisplayPort cover to the screw hole on the optional DisplayPort module.
6. Replace the screw (M2x4) that secures the optional DisplayPort cover to the optional DisplayPort module.

### Next steps

1. Install the [processor heat-sink assembly](#).
2. Install the [processor fan](#).
3. Install the [drive-bay](#).
4. Install the [3.5-inch hard drive](#).
5. Install the [front cover](#).
6. Install the [side cover](#).
7. Follow the procedure in [after working inside your computer](#).

## Removing the optional 5 GbE Optical module

### Prerequisites

1. Follow the procedure in [before working inside your computer](#).
2. Remove the [side cover](#).
3. Remove the [front cover](#).
4. Remove the [3.5-inch hard drive](#).
5. Remove the [drive-bay](#).
6. Remove the [processor fan](#).

7. Remove the [processor heat-sink assembly](#).

### About this task

The following image indicates the location of the optional 5 GbE Optical module and provides a visual representation of the removal procedure.

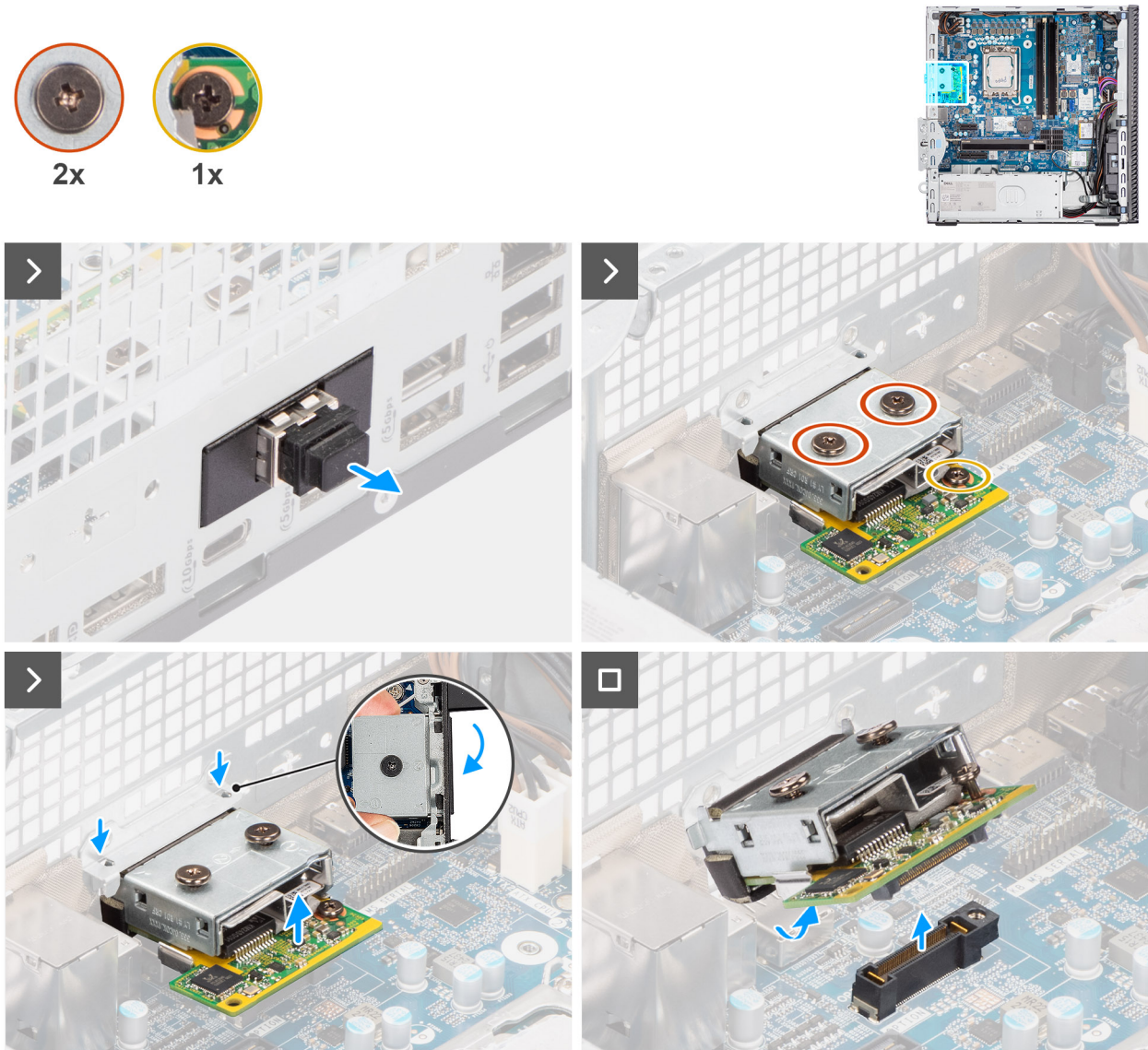

**Figure 79. Removing the optional 5GbE Optical module**

### Steps

1. Remove the optical fiber connector cover from the optional 5 GbE Optical module.
2. Remove the two screws (M2x4) that secure the optional 5 GbE Optical module cover to the optional 5 GbE Optical module.
3. Remove the screw (M2x4) that secures the optional 5 GbE Optical module to the system board.
4. Lift the optional 5 GbE Optical module at an angle and remove the tabs on the module from the slots on the chassis.
5. Remove the optional 5 GbE Optical module off the system board.

## Installing the optional 5 GbE Optical module

### Prerequisites

If you are replacing a component, remove the existing component before performing the installation process.



**About this task**

- NOTE:** The optional-port modules are mutually exclusive; only a single module can be installed at a time.
- NOTE:** Ensure to reapply thermal grease when installing the processor heat sink after an optional module installation to maintain optimal functionality.

The following images indicate the location of the optional 5 GbE Optical module and provide a visual representation of the installation procedure.

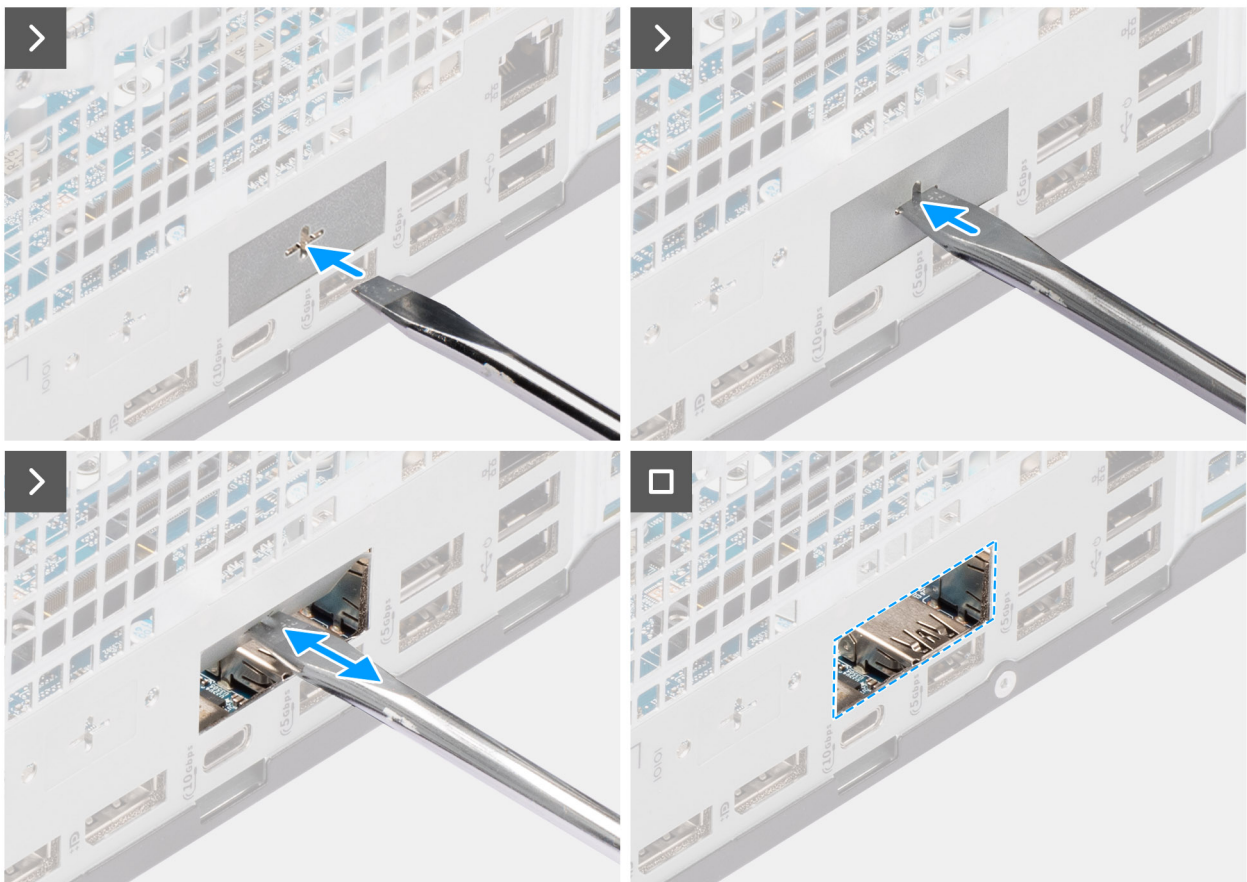

**Figure 80. Installing the optional 5GbE Optical module**

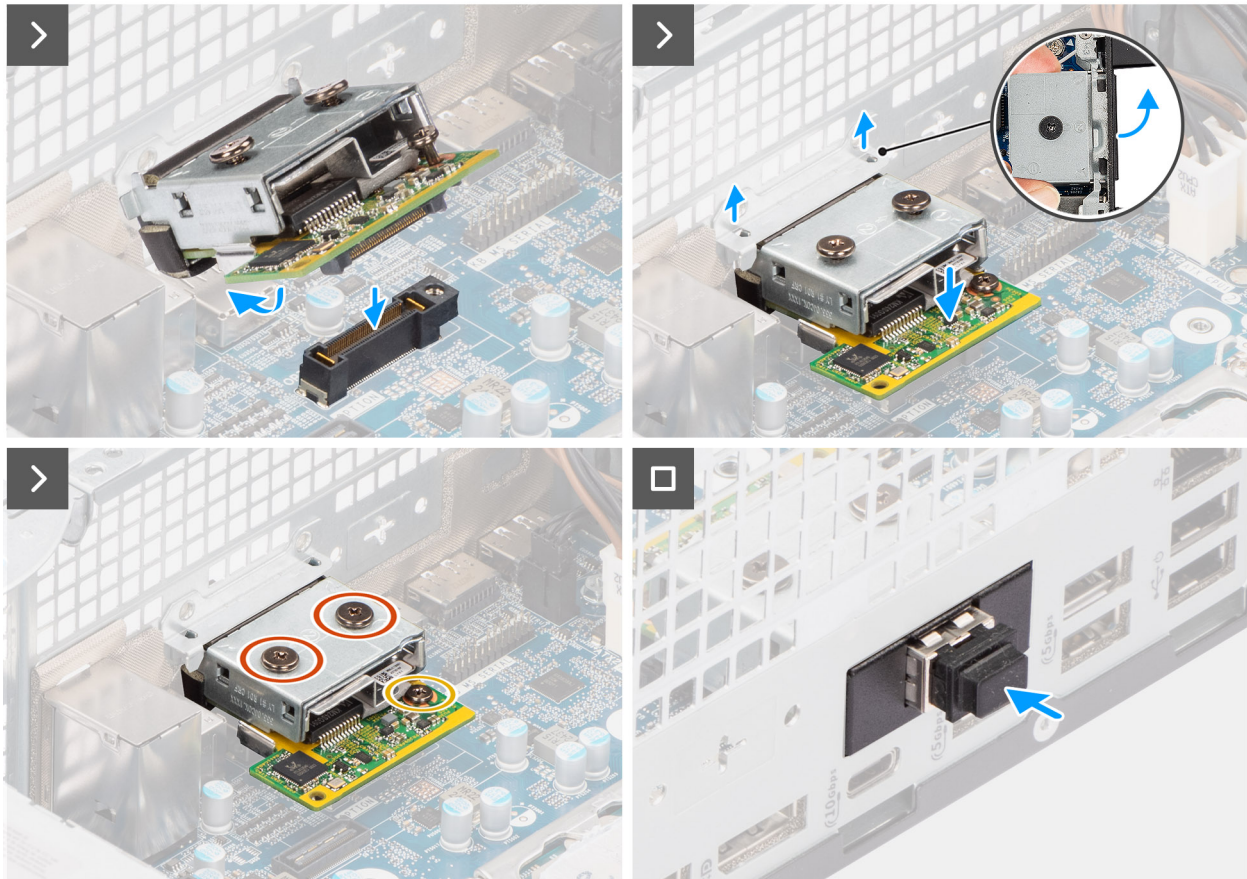
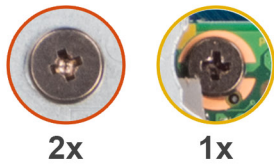

**Figure 81. Installing the optional 5GbE Optical module**

**Steps**

1. Using a screw driver, push against the optional-port cover until it comes off.  
 (i) **NOTE:** This step is only applicable if you are installing the optional-port module on a computer that did not previously have it installed.
2. Place the optional 5 GbE Optical module at an angle and align the tabs on the module to the slots on the chassis.
3. Align the optional 5 GbE Optical module to the slot on the chassis and connect the module to the connector on the system board (OPTION).
4. Replace the screw (M2x4) that secures the optional 5 GbE Optical module to the system board.
5. Align the screw on the optional 5 GbE Optical module cover to the screw hole on the optional 5 GbE Optical module.
6. Replace the two screws (M2x4) that secure the optional 5 GbE Optical module cover to the optional 5 GbE Optical module.
7. Install the optical fiber connector cover on the optional 5 GbE Optical module.

**Next steps**

1. Install the [processor heat-sink assembly](#).
2. Install the [processor fan](#).
3. Install the [drive-bay](#).
4. Install the [3.5-inch hard drive](#).



5. Install the [front cover](#).
6. Install the [side cover](#).
7. Follow the procedure in [after working inside your computer](#).

## System board

### Removing the system board

 **CAUTION:** The information in this removal section is intended for authorized service technicians only.

#### Prerequisites

1. Follow the procedure in [Before working inside your computer](#).
2. Remove the [side cover](#).
3. Remove the [coin-cell battery](#).
4. Remove the [front cover](#).
5. Remove the [3.5-inch hard drive](#), if applicable.
6. Remove the [optical drive](#), if applicable.
7. Remove the [drive-bay](#).
8. Remove the [graphics card](#), if applicable.
9. Remove the [memory modules](#).
10. Remove the [solid state drives](#), whichever is applicable.
11. Remove the [wireless card](#).
12. Remove the [intrusion switch](#).
13. Remove the [antenna module](#).
14. Remove the [processor fan](#).
15. Remove the [processor heat-sink assembly](#).
16. Remove the [processor](#).

#### About this task

The following image indicates the connectors on your system board.

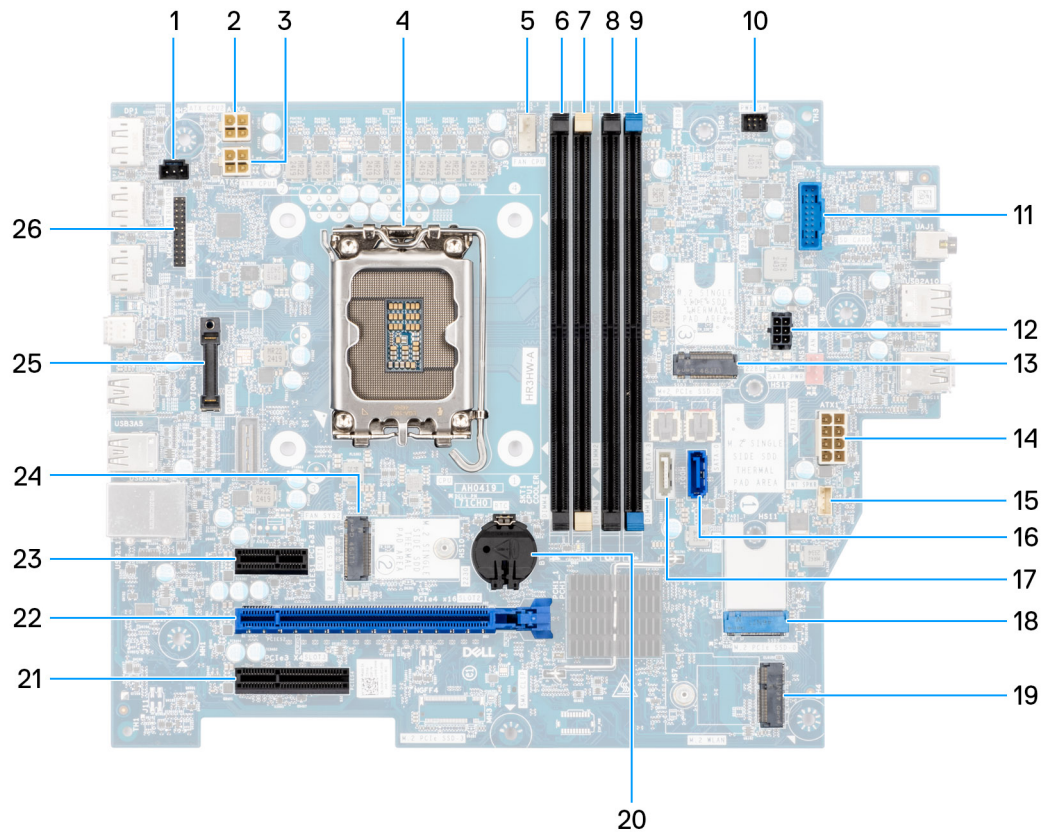

**Figure 82. System board overview**

1. Intrusion-switch connector (INTRUSION)
2. Processor-power cable connector (ATX CPU2)
3. Processor-power connector (ATX CPU1)
4. Processor socket (CPU)
5. Processor-fan and heat-sink assembly connector (FAN CPU)
6. UDIMM memory slot (DIMM4)
7. UDIMM memory slot (DIMM2)
8. UDIMM memory slot (DIMM3)
9. UDIMM memory slot (DIMM1)
10. Power-button connector (PWR SW)
11. Media-card reader connector (SD CARD)
12. Hard-drive and optical-drive power connector (SATA PWR)
13. Solid state drive slot (M.2 PCIe SSD 2)
14. System-board power connector (ATX SYS)
15. Internal-speaker connector (INT SPKR)
16. Optical-drive data connector (SATA 0)
17. Hard-drive data connector (SATA 3)
18. Solid state drive slot (M.2 PCIe SSD 0)
19. Wireless-card slot (M.2 WLAN)
20. Coin-cell battery socket (RTC)
21. PCIe x4 slot (SLOT3)
22. PCIe x16 slot (SLOT 2)
23. PCIe x1 slot (SLOT 1)
24. Solid state drive slot (M.2 PCIe SSD 1)
25. Optional-port module (OPTION)
26. Serial-port module (KB MS SERIAL)

The following images indicate the location of the system board and provide a visual representation of the removal procedure.

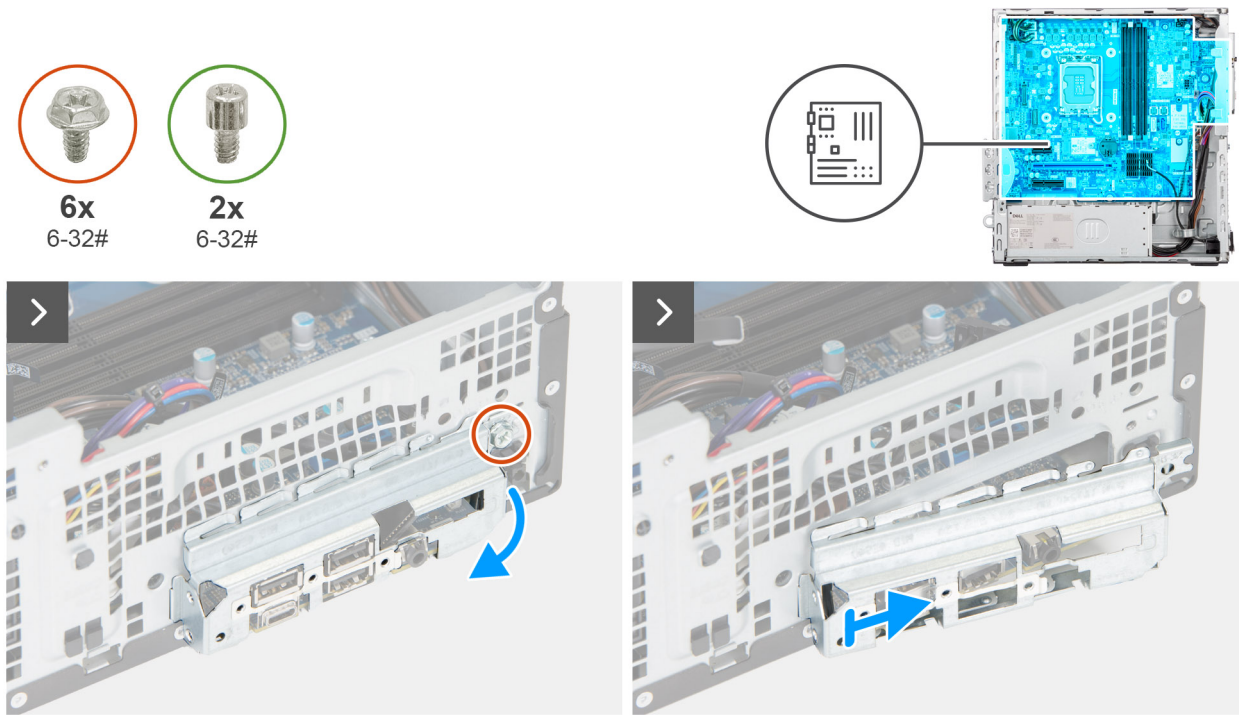

Figure 83. Removing the system board

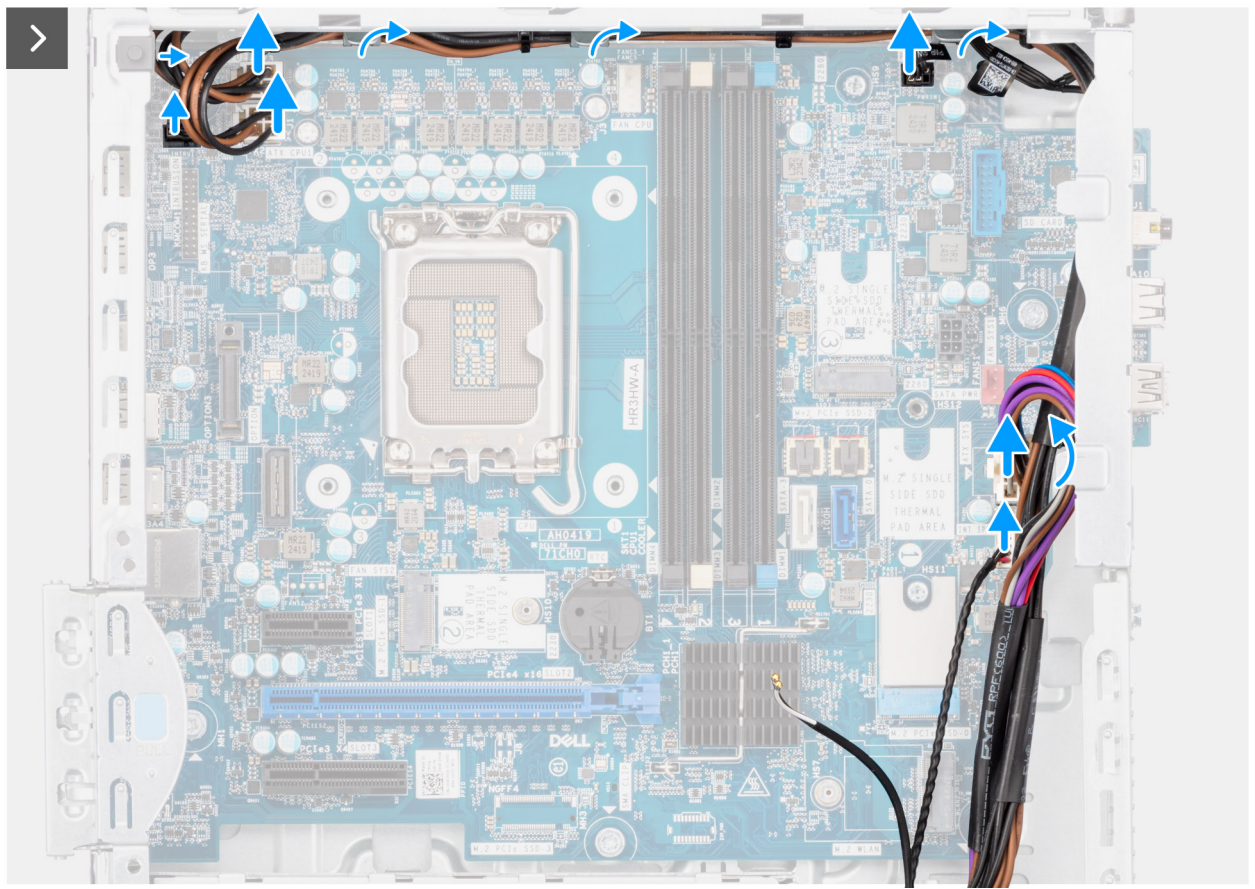
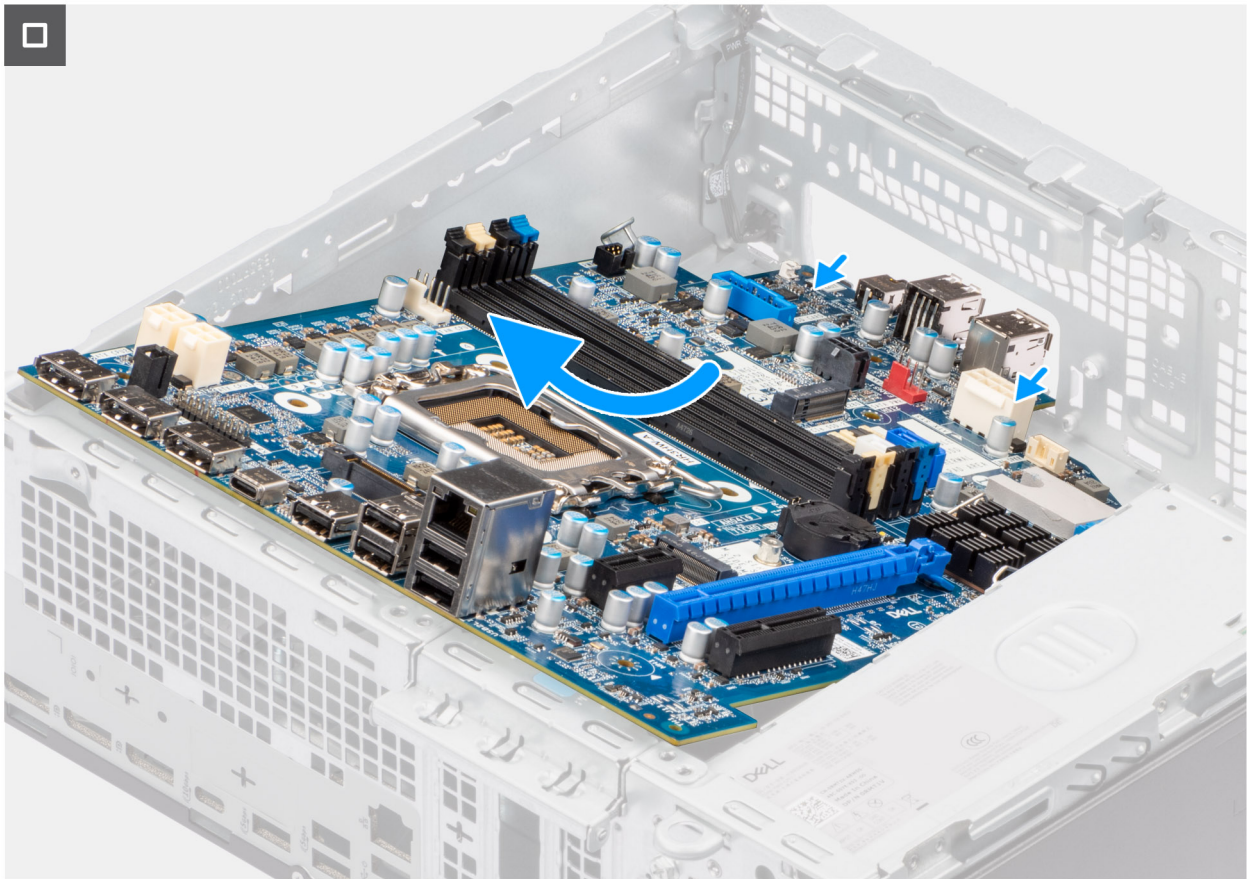

Figure 84. Removing the system board





Figure 85. Removing the system board



**Figure 86. Removing the system board**

### Steps

1. Remove the screw (#6-32) that secures the front I/O bracket to the chassis.
2. Rotate and remove the front I/O-bracket from the chassis.
3. Disconnect the hard-drive data cable from its connector (SATA-0) on the system board.
4. Remove the hard-drive data cable from its routing guides and keep it away.
5. Disconnect the power-supply cables from their connectors (ATX CPU1, ATX CPU2, and ATX SYS) on the system board.
6. Disconnect the power button cable from its connector (PWR SW) on the system board.
7. Disconnect the chassis-fan cable from its connector (FAN SYS) on the system board.
8. Disconnect the speaker cable from its connector (INT SPKR) on the system board.
9. Disconnect the SATA power cable from its connector (SATA PWR) on the system board.
10. Remove the five screws (#6-32) that secure the system board to the chassis.
11. Remove the two standoff screws (#6-32) that secure the system board to the chassis.
12. Free the system board from the back I/O panel by sliding it towards the right and lift the system board out of the chassis.

## Installing the system board

**CAUTION:** The information in this removal section is intended for authorized service technicians only.

### Prerequisites

If you are replacing a component, remove the existing component before performing the installation procedure.

### About this task

The following image indicates the connectors on your system board.



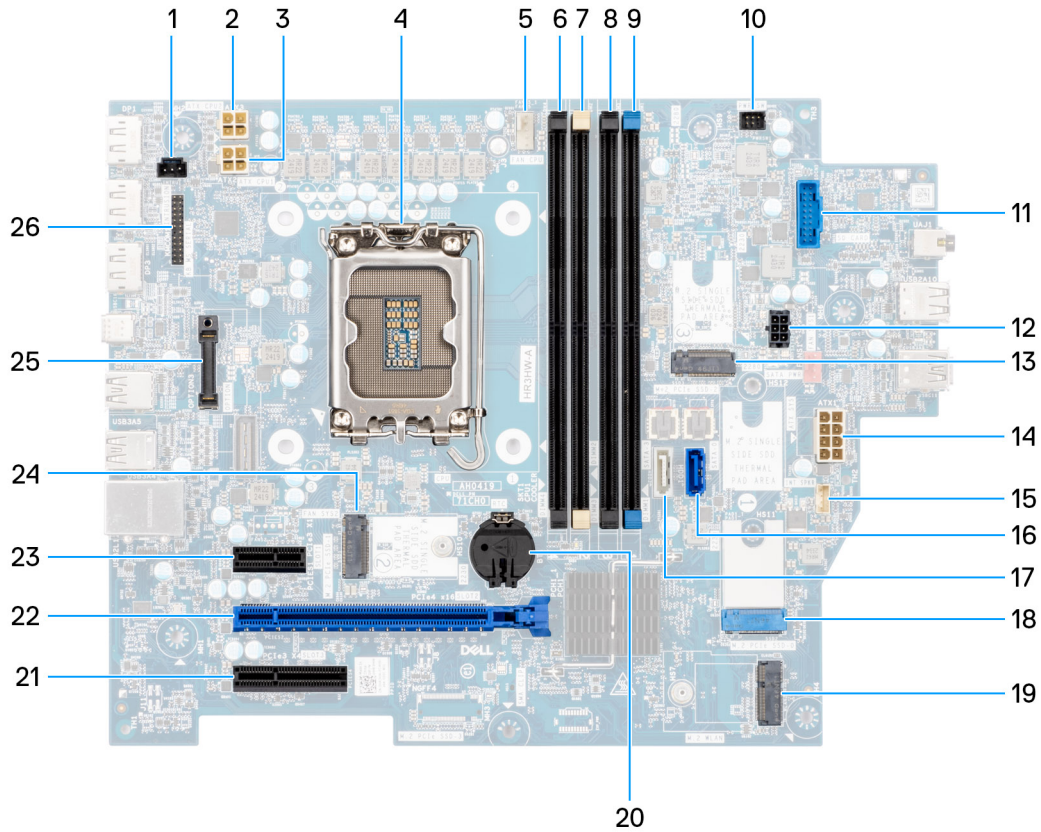

**Figure 87. System board overview**

1. Intrusion-switch connector (INTRUSION)
2. Processor-power cable connector (ATX CPU2)
3. Processor-power connector (ATX CPU1)
4. Processor socket (CPU)
5. Processor-fan and heat-sink assembly connector (FAN CPU)
6. UDIMM memory slot (DIMM4)
7. UDIMM memory slot (DIMM2)
8. UDIMM memory slot (DIMM3)
9. UDIMM memory slot (DIMM1)
10. Power-button connector (PWR SW)
11. Media-card reader connector (SD CARD)
12. Hard-drive and optical-drive power connector (SATA PWR)
13. Solid state drive slot (M.2 PCIe SSD 2)
14. System-board power connector (ATX SYS)
15. Internal-speaker connector (INT SPKR)
16. Optical-drive data connector (SATA 0)
17. Hard-drive data connector (SATA 3)
18. Solid state drive slot (M.2 PCIe SSD 0)
19. Wireless-card slot (M.2 WLAN)
20. Coin-cell battery socket (RTC)
21. PCIe x4 slot (SLOT3)
22. PCIe x16 slot (SLOT 2)
23. PCIe x1 slot (SLOT 1)
24. Solid state drive slot (M.2 PCIe SSD 1)
25. Optional-port module (OPTION)
26. Serial-port module (KB MS SERIAL)

The following images indicate the location of the system board and provide a visual representation of the installation procedure.

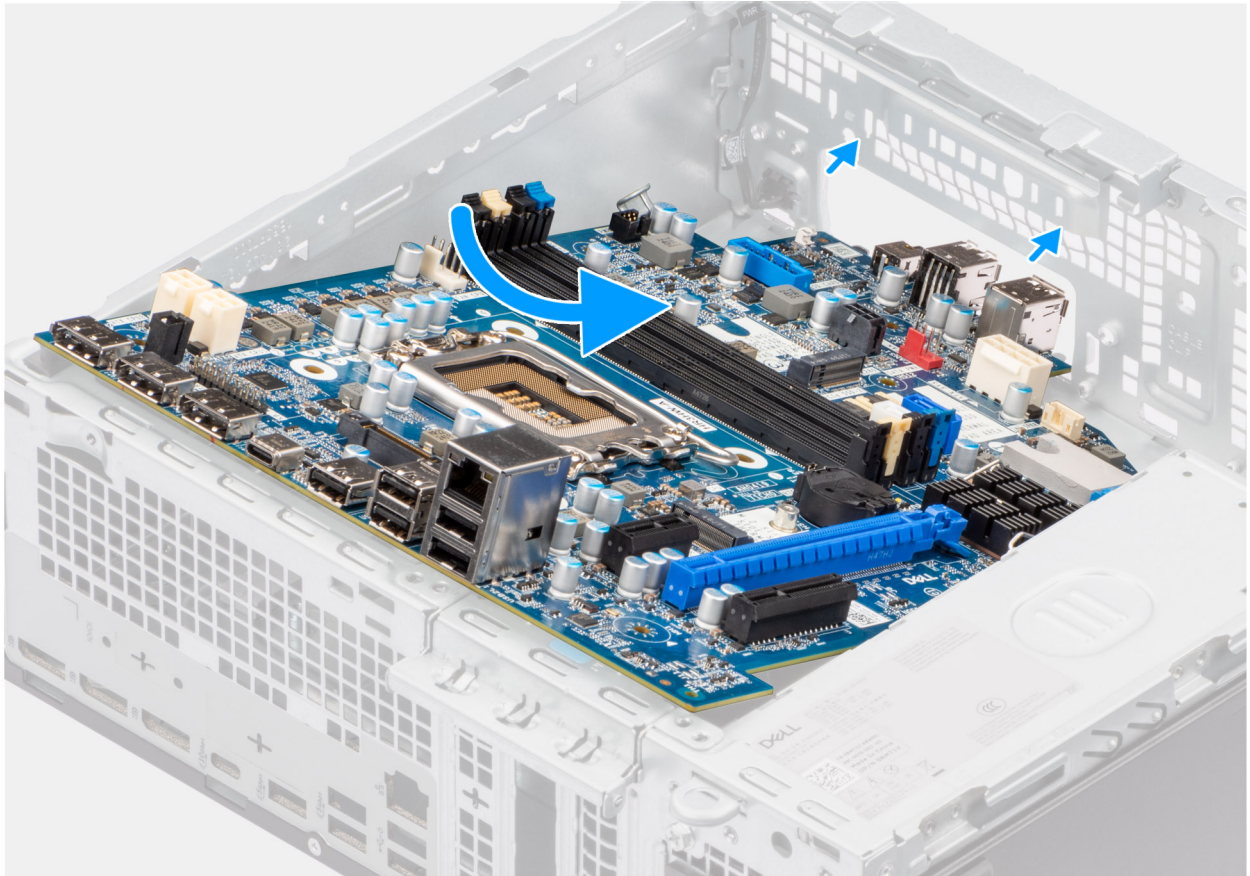

Figure 88. Installing the system board





Figure 89. Installing the system board

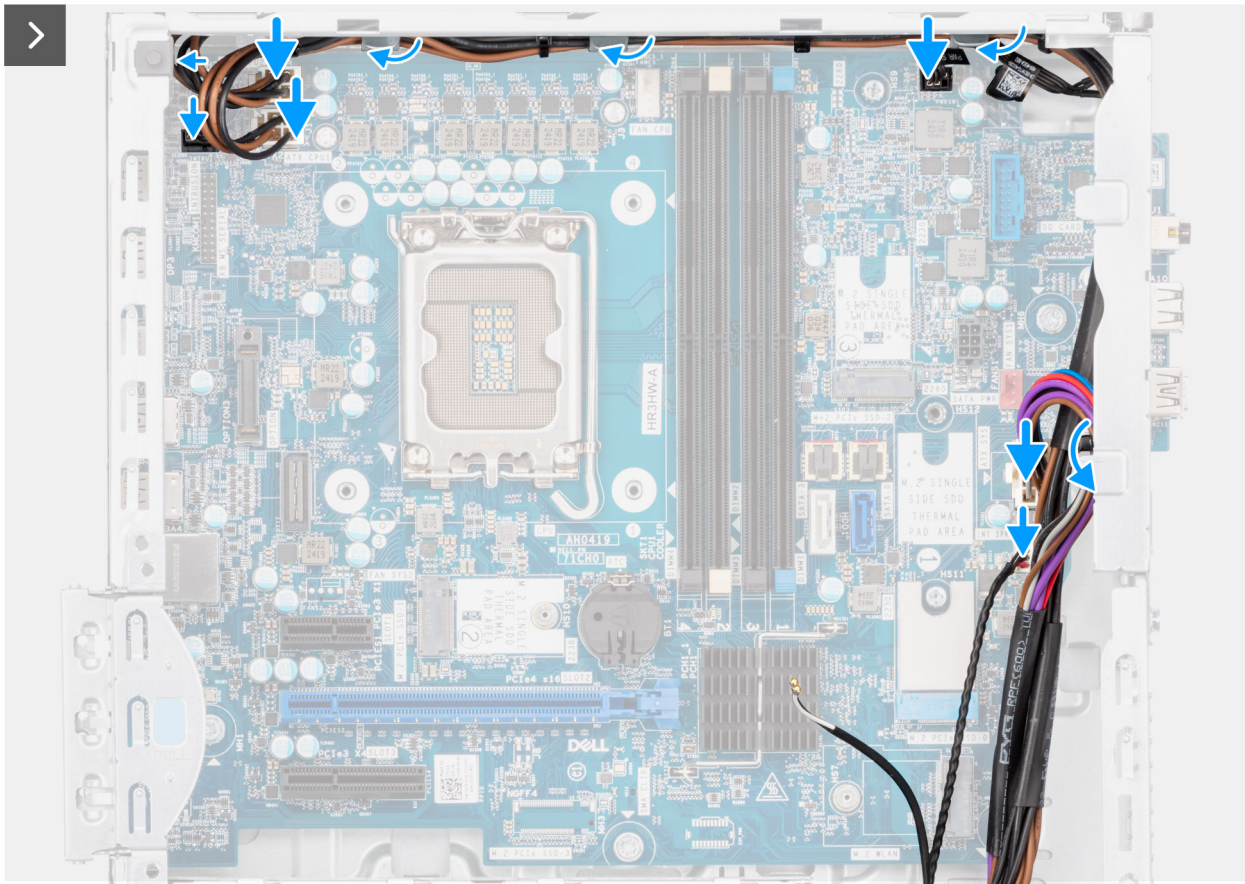

Figure 90. Installing the system board

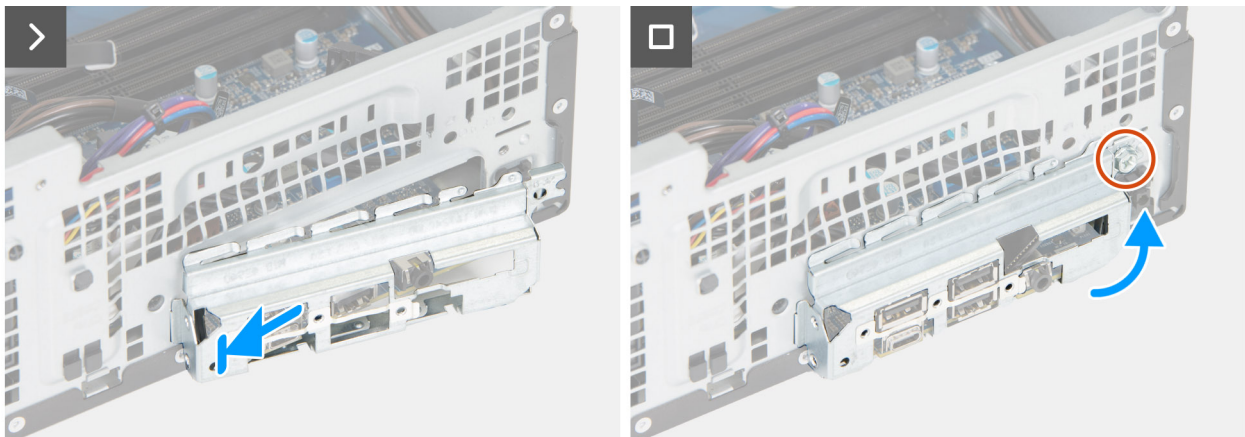

Figure 91. Installing the system board

**Steps**

1. Align and lower the system board into the computer until the standoff points at the back of the system board align with those on the chassis.
2. Replace the two standoff screws (#6-32) that secure the system board to the chassis.
3. Replace the five (#6-32) screws that secure the system board to the chassis.
4. Route and connect the SATA power cable to its connector (SATA PWR) on the system board.
5. Route and connect the speaker cable to its connector (INT SPKR) on the system board.
6. Route and connect the system-fan cable to its connector (FAN SYS) on the system board.
7. Route and connect the power-button cable to its connector (PWR SW) on the system board.
8. Route and connect the power-supply cables to their connectors (ATX CPU1, ATX CPU2, and ATX SYS) on the system board.

9. Route and connect the hard drive cable to its connector (SATA-0) on the system board.
10. Place and align the front I/O-bracket with the I/O slot on the chassis.
11. Replace the screw (6-32#) that secures the front I/O-bracket to the chassis.

#### **Next steps**

1. Install the [processor](#).
2. Install the [processor heat-sink assembly](#).
3. Install the [processor fan](#).
4. Install the [intrusion switch](#).
5. Install the [wireless card](#).
6. Install the [solid state drives](#).
7. Install the [memory modules](#).
8. Install the [graphics card](#).
9. Install the [drive-bay](#).
10. Install the [3.5-inch hard drive](#), if applicable.
11. Install the [optical drive](#), if applicable.
12. Install the [front cover](#).
13. Install the [coin-cell battery](#).
14. Install the [side cover](#).
15. Follow the procedure in [After working inside your computer](#).



# Software

This chapter details the supported operating systems along with instructions on how to install the drivers.

## Operating system

Your Dell Pro Max Slim FCS1250 supports the following operating systems:

- Windows 11 Home
- Windows 11 Pro
- Windows 11 Pro National Academic
- Windows 11 Enterprise
- Ubuntu Linux 24.04 LTS

## Drivers and downloads

When troubleshooting, downloading, or installing drivers, it is recommended that you read the Dell Knowledge Base article [Drivers and Downloads FAQs 000123347](#).

# BIOS Setup

**CAUTION:** Certain changes can make your computer work incorrectly. Before you change the settings in BIOS Setup, it is recommended that you note down the original settings for future reference.

**NOTE:** Depending on the computer and the installed devices, the options that are listed in this section may or may not be displayed.

Use BIOS Setup for the following purposes:

- Get information about the hardware installed in your computer, such as the amount of RAM and the capacity of the storage device.
- Change the system configuration information.
- Set or change a user-selectable option, such as the user password, type of storage device that is installed, and enable or disable base devices.

## Entering BIOS Setup program

### About this task

Turn on (or restart) your computer and press F2 immediately.

## Navigation keys

**NOTE:** For most of the BIOS Setup options, changes that you make are recorded but do not take effect until you restart the computer.

**Table 27. Navigation keys**

Keys	Navigation
Up arrow	Moves to the previous field.
Down arrow	Moves to the next field.
Enter	Selects a value in the selected field (if applicable) or follows the link in the field.
Spacebar	Expands or collapses a drop-down list, if applicable.
Tab	Moves to the next focus area.
Esc	Moves to the previous page until you view the main screen. Pressing Esc in the main screen displays a message that prompts you to save any unsaved changes and restart the computer.

## One time boot menu

To access the **one time boot menu**, turn on your computer, and then press F2 immediately.

**NOTE:** If your computer fails to enter the boot menu, restart the computer and press F2 immediately.

The one-time boot menu displays the devices that you can boot from, and also displays the option to start diagnostics. The boot menu options are:

- Removable Drive (if available)

- STXXXX Drive (if available)

**NOTE:** XXX denotes the SATA drive number.

- Optical Drive (if available)
- SATA Hard Drive (if available)
- Diagnostics

**NOTE:** Choosing **Diagnostics**, will display the **ePSA diagnostics** screen.

The **one time boot menu** also displays the option to access the System Setup screen.

## F12 One Time Boot menu

To enter the One Time Boot menu, turn on or restart your computer, and then press F12 immediately.

**NOTE:** If you are unable to enter the One Time Boot menu, repeat the above action.

The One Time Boot menu displays the devices that you can boot from and also display the options to start diagnostics. The boot menu options are:

- Removable Drive (if available)
- STXXXX Drive (if available)

**NOTE:** XXX denotes the SATA drive number.

- Optical Drive (if available)
- SATA Hard Drive (if available)
- Diagnostics

The One Time Boot menu screen also displays the option to access BIOS Setup.

## System setup options

**NOTE:** Depending on your computer and its installed devices, the items that are listed in this section may or may not appear.

**Table 28. System setup options—System information menu**

Overview	
<b>Dell Pro Max Slim FCS12250</b>	
BIOS Version	Displays the BIOS version number.
Service Tag	Displays the Service Tag of the computer.
Asset Tag	Displays the Asset Tag of the computer.
Manufacture Date	Displays the manufacture date of the computer.
Ownership Date	Displays the ownership date of the computer.
Express Service Code	Displays the express service code of the computer.
Ownership Tag	Displays the Ownership Tag of the computer.
<b>Processor Information</b>	
Processor Type	Displays the processor type.
Maximum Clock Speed	Displays the maximum processor clock speed.
Processor L2 Cache	Displays the processor L2 Cache size.
Processor L3 Cache	Displays the processor L3 Cache size.

**Table 28. System setup options—System information menu (continued)**

<b>Overview</b>	
Intel vPro Technology	Displays whether the processor is Intel vPro Technology capable.
<b>Memory Information</b>	
Memory Installed	Displays the total computer memory installed.
Memory Speed	Displays the memory speed.
DIMM 1 Size	Displays the DIMM 1 memory size.
DIMM 2 Size	Displays the DIMM 2 memory size.
DIMM 3 Size	Displays the DIMM 3 memory size.
DIMM 4 Size	Displays the DIMM 4 memory size.
<b>Devices Information</b>	
Video Controller	Displays the video controller type of the computer.
Video Memory	Displays the video memory information of the computer.
Wi-Fi Device	Displays the wireless device information of the computer.
Native Resolution	Displays the native resolution of the computer.
Audio Controller	Displays the audio controller information of the computer.
Bluetooth Device	Displays the Bluetooth device information of the computer.
LOM MAC Address	Displays the LAN On Motherboard (LOM) MAC address of the computer.
dGPU Video Controller	Displays the discrete video controller type of the computer.
LOM 2 MAC Address	Displays the second LAN On Motherboard (LOM) MAC address of the computer.
Slot 1	Displays the SATA hard drive information of the computer.
Slot 2	Displays the SATA hard drive information of the computer.

**Table 29. System setup options—Boot Configuration menu**

<b>Boot Configuration</b>	
<b>Boot Sequence</b>	
Boot Mode: UEFI only	Displays the boot mode.
Boot Sequence	Displays the boot sequence.
<b>Enable PXE Boot Priority</b>	Enable or disable the PXE Boot priority.  By default, the <b>Enable PXE Boot Priority</b> option is not enabled.  When enabled and if a PXE boot option is detected, it will be added to the top of the boot sequence.
<b>Force PXE On Next Boot</b>	Enable or disable the Force PXE On the next boot.  By default, the <b>Force PXE On Next Boot</b> option is not enabled.
<b>Secure Boot</b>	
Enable Secure Boot	Enable or disable the secure boot feature.  By default, the option is not enabled.
Secure Boot Mode	Enable or disable to change the secure boot mode options.  By default, the <b>Deployed Mode</b> is enabled.
<b>Expert Key Management</b>	
Enable Custom Mode	Enable or disable the custom mode.

**Table 29. System setup options—Boot Configuration menu (continued)**

Boot Configuration	
	By default, the <b>custom mode</b> option is not enabled.
Custom Mode Key Management	Select the custom values for expert key management.

**Table 30. System setup options—Integrated Devices menu**

Integrated Devices	
<b>Date/Time</b>	Displays the current date in MM/DD/YYYY format and current time in HH:MM:SS AM/PM format.
<b>Audio</b>	
Enable Audio	Enable or disable the integrated audio controller. By default, all the options are enabled.
<b>USB/Thunderbolt Configuration</b>	Enable or disable booting from USB mass storage devices through the boot sequence or boot menu. By default, all the options are enabled.
<b>Enable Thunderbolt Technology Support</b>	Enable or disable the Thunderbolt Technology Support. By default, all the options are enabled. <b>i NOTE:</b> Enabling the "Enable Thunderbolt Adaptor Boot Support" or "Enable Thunderbolt Adapter Pre-boot Modules" options may allow devices connected to the Thunderbolt adaptor during pre-boot to function in the operation system regardless of the Security Level selected in the BIOS Setup. The device will continue to operate in the operating system until it is disconnected. When reconnected while within the operating system, the device will connect according to the Security Level and previous operating system authorizations.
<b>Front USB Configuration</b>	Enable or disable the individual front USB ports. By default, all the options are enabled.
<b>Rear USB Configuration</b>	Enable or disable the individual rear USB ports. By default, all the options are enabled.

**Table 31. System setup options—Storage menu**

Storage	
<b>Storage Interface</b>	
Port Enablement	Enable or disable the onboard drives. By default, all the options are enabled.
<b>Drive Information</b>	
<b>SATA-0</b>	
Type	Displays the SATA HDD type information of the computer.
Device	Displays the SATA HDD device information of the computer.
<b>SATA-1</b>	
Type	Displays the SATA HDD type information of the computer.
Device	Displays the SATA HDD device information of the computer.
<b>M.2 PCIe SSD-0</b>	
Type	Displays the M.2 PCIe SSD-0 type information of the computer.



**Table 31. System setup options—Storage menu (continued)**

Storage	
Device	Displays the M.2 PCIe SSD-0 device information of the computer.
<b>M.2 PCIe SSD-1</b>	
Type	Displays the M.2 PCIe SSD-1 type information of the computer.
Device	Displays the M.2 PCIe SSD-1 device information of the computer.
<b>M.2 PCIe SSD-2</b>	
Type	Displays the M.2 PCIe SSD-2 type information of the computer.
Device	Displays the M.2 PCIe SSD-2 device information of the computer.
<b>Enable MediaCard</b>	
Secure Digital (SD) Card	Enable or disable the SD card. By default, the <b>Secure Digital (SD) Card</b> option is enabled.
Secure Digital (SD) Card Read-Only Mode	Enable or disable the SD card read-only mode. By default, the <b>Secure Digital (SD) Card Read-Only Mode</b> option is not enabled.

**Table 32. System setup options—Security menu**

Security	
<b>TPM 2.0 Security</b>	
<b>Chassis intrusion</b>	
	Controls the chassis intrusion feature. By default, the option is disabled.
Absolute	Enable or disable or permanently disable the BIOS module interface of the optional Absolute Persistence Module service from Absolute software. By default, the <b>Enable Absolute</b> option is enabled.
Firmware Device Tamper Detection	Enable or disable the Firmware Device Tamper Detection. By default, the <b>Silent</b> option is enabled.
Clear Firmware Device Tamper Detection	Enable or disable the Clear Firmware Device Tamper Detection. By default, the <b>Clear Firmware Device Tamper Detection</b> option is disabled.

**Table 33. System setup options—Passwords menu**

Passwords	
<b>Admin Password</b>	Set, change, or delete the administrator password.
<b>System Password</b>	Set, change, or delete the computer password.
<b>M.2 PCIe SSD-0</b>	Set, change, or delete the M.2 PCIe SSD-0 password.

**Table 34. System setup options—Update, Recovery menu**

Update, Recovery	
<b>SupportAssist OS Recovery</b>	Enable or disable the boot flow for SupportAssist OS Recovery tool in the event of certain computer errors. By default, the option is enabled.
<b>BIOSConnect</b>	Enable or disable cloud Service operating system recovery if the main operating system fails to boot with the number of failures equal to or greater than the value specified by the Auto operating system Recovery Threshold setup option and local Service operating system does not boot or is not installed.

**Table 34. System setup options—Update, Recovery menu (continued)**

Update, Recovery	
	By default, the option is enabled.
<b>Dell Auto OS Recovery Threshold</b>	Controls the automatic boot flow for SupportAssist System Resolution Console and for Dell OS Recovery Tool. By default, the threshold value is set to 2.

**Table 35. System setup options—System Management menu**

System Management	
<b>Service Tag</b>	Display the Service Tag of the computer.
<b>Asset Tag</b>	Create a computer Asset Tag.
<b>First Power On Date</b>	
Set Ownership Date	Enable or disable the Ownership date. By default, the option is disabled.

**Table 36. System setup options—Keyboard menu**

Keyboard	
<b>Keyboard Errors</b>	
<b>Numlock LED</b>	
Enable Numlock LED	Enable or disable the Numlock LED. By default, the option is enabled.

**Table 37. System setup options—Pre-boot Behavior menu**

Pre-boot Behavior	
<b>Warning and Errors</b>	Enable or disable the action to be done when a warning or error is encountered. By default, the <b>Prompt on Warnings and Errors</b> option is enabled.

**Table 38. System setup options—System Logs menu**

System Logs	
<b>BIOS Event Log</b>	
Clear BIOS event log	Display BIOS events. By default, the <b>Keep Log</b> option is enabled.
<b>Power Event Log</b>	
Clear Power event log	Display Power events. By default, the <b>Keep Log</b> option is enabled.

## Updating the BIOS

### Updating the BIOS in Windows

#### About this task

 **CAUTION:** If BitLocker is not suspended before updating the BIOS, the BitLocker key is not recognized the next time you reboot the computer. You will then be prompted to enter the recovery key to proceed, and the

**computer displays a prompt for the recovery key on each reboot. Failure to provide the recovery key can result in data loss or an operating system reinstall. For more information, see the Knowledge Base Resource [updating the BIOS on Dell systems with BitLocker enabled](#).**

### Steps

1. Go to [Dell Support Site](#).
2. Go to **Identify your product or search support**. In the box, enter the product identifier, model, service request or describe what you are looking for, and then click **Search**.

 **NOTE:** If you do not have the Service Tag, use the SupportAssist to automatically identify your computer. You can also use the product ID or manually browse for your computer model.

3. Click **Drivers & Downloads**. Expand **Find drivers**.
4. Select the operating system installed on your computer.
5. In the **Category** drop-down list, select **BIOS**.
6. Select the latest version of BIOS, and click **Download** to download the BIOS file for your computer.
7. After the download is complete, browse the folder where you saved the BIOS update file.
8. Double-click the BIOS update file icon and follow the on-screen instructions.

For more information, search in the Knowledge Base Resource at [Dell Support Site](#).

## Updating the BIOS in Linux and Ubuntu

To update the system BIOS on a computer that is installed with Linux or Ubuntu, see the knowledge base article [000131486](#) at [Dell Support Site](#).

## Updating the BIOS using the USB drive in Windows

### About this task

 **CAUTION:** If BitLocker is not suspended before updating the BIOS, the BitLocker key is not recognized the next time you reboot the computer. You will then be prompted to enter the recovery key to proceed, and the computer displays a prompt for the recovery key on each reboot. Failure to provide the recovery key can result in data loss or an operating system reinstall. For more information, see the Knowledge Base Resource [updating the BIOS on Dell systems with BitLocker enabled](#).

### Steps

1. Go to [Dell Support Site](#).
2. Go to **Identify your product or search support**. In the box, enter the product identifier, model, service request or describe what you are looking for, and then click **Search**.

 **NOTE:** If you do not have the Service Tag, use the SupportAssist to automatically identify your computer. You can also use the product ID or manually browse for your computer model.

3. Click **Drivers & Downloads**. Expand **Find drivers**.
4. Select the operating system installed on your computer.
5. In the **Category** drop-down list, select **BIOS**.
6. Select the latest version of BIOS, and click **Download** to download the BIOS file for your computer.
7. Create a bootable USB drive. For more information, search in the Knowledge Base Resource at [Dell Support Site](#).
8. Copy the BIOS setup program file to the bootable USB drive.
9. Connect the bootable USB drive to the computer that needs the BIOS update.
10. Restart the computer and press **F12**.
11. Select the USB drive from the **One Time Boot Menu**.
12. Type the BIOS setup program filename and press **Enter**.  
The **BIOS Update Utility** appears.

13. Follow the on-screen instructions to complete the BIOS update.

## Updating the BIOS from the One-Time boot menu

You can run the BIOS flash update file from Windows using a bootable USB drive or you can also update the BIOS from the One-Time boot menu on the computer. To update your computers BIOS, copy the BIOS XXXX.exe file onto a USB drive formatted with the FAT32 file system. Then, restart your computer and boot from the USB drive using the One-Time Boot Menu.

### About this task

**CAUTION:** If BitLocker is not suspended before updating the BIOS, the next time you reboot the computer it will not recognize the BitLocker key. You will then be prompted to enter the recovery key to progress, and the computer will ask for this on each reboot. If the recovery key is not known this can result in data loss or an unnecessary operating system reinstall. For more information about this subject, search in the Knowledge Base Resource at [Dell Support Site](#).

### BIOS Update

To confirm if the BIOS Flash Update is listed as a boot option, you can boot your computer to the **One Time Boot** Menu. If the option is listed, then the BIOS can be updated using this method.

To update your BIOS from the One-Time boot menu, you need the following:

- USB drive formatted to the FAT32 file system (the drive does not have to be bootable)
- BIOS executable file that you downloaded from the Dell Support website and copied to the root of the USB drive
- AC power adapter must be connected to the computer
- A functional computer battery to flash the BIOS

Perform the following steps to update the BIOS from the One-Time boot menu:

**CAUTION:** Do not turn off the computer during the BIOS flash update process. The computer may not boot if you turn off your computer.

### Steps

1. Turn off the computer, insert the USB drive that contains the BIOS flash update file.
2. Turn on the computer and press **F12** to access the **One Time Boot** Menu. Select **BIOS Update** using the mouse or arrow keys then press Enter.  
The flash BIOS menu is displayed.
3. Click **Flash from file**.
4. Select the external USB device.
5. Select the file and double-click the flash target file, and then click **Submit**.
6. Click **Update BIOS**. The computer restarts to flash the BIOS.
7. The computer will restart after the BIOS flash update is completed.

## System and setup password

**CAUTION:** The password features provide a basic level of security for the data on your computer.

**CAUTION:** Ensure that your computer is locked when it is not in use. Anyone can access the data that is stored on your computer, when left unattended.

**Table 39. System and setup password**

Password type	Description
System password	Password that you must enter to boot to your operating system.

**Table 39. System and setup password (continued)**

Password type	Description
Setup password	Password that you must enter to access and change the BIOS settings of your computer.

You can create a system password and a setup password to secure your computer.

 **NOTE:** The System and setup password feature is disabled by default.

## Assigning a System Setup password

### Prerequisites

You can assign a new System or Admin Password only when the status is set to **Not Set**. To enter BIOS System Setup, press F2 immediately after a power-on or reboot.

### Steps

1. In the **System BIOS** or **System Setup** screen, select **Security** and press Enter.  
The **Security** screen is displayed.
2. Select **System/Admin Password** and create a password in the **Enter the new password** field.  
Use the following guidelines to create the system password:
  - Password can be up to 32 characters.
  - Password must contain at least one special character: "( ! " # \$ % & ' \* + , - . / : ; < = > ? @ [ \ ] ^ \_ ` { | } )" )"
  - The password can contain numbers from 0 to 9.
  - The password can contain alphabets A to Z and a to z.
3. Type the system password that you entered earlier in the **Confirm new password** field and click **OK**.
4. Press Y to save the changes.  
The computer restarts.

## Deleting or changing an existing system password or setup password

### Prerequisites

Ensure that the **Password Status** is Unlocked in the System Setup before attempting to delete or change the existing system password and/or setup password. You cannot delete or change an existing system password or setup password if the **Password Status** is Locked. To enter the System Setup, press F2 immediately after a power-on or reboot.

### Steps

1. In the **System BIOS** or **System Setup** screen, select **System Security** and press Enter.  
The **System Security** screen is displayed.
2. In the **System Security** screen, verify that the **Password Status** is Unlocked.
3. Select **System Password**. Update or delete the existing system password, and press Enter or Tab.
4. Select **Setup Password**. Update or delete the existing setup password, and press Enter or Tab.  
 **NOTE:** If you change the system password and/or setup password, reenter the new password when prompted. If you delete the system password and/or setup password, confirm the deletion when prompted.
5. Press Esc. A message prompts you to save the changes.
6. Press Y to save the changes and exit from **System Setup**.  
The computer restarts.



# Clearing CMOS settings

## About this task

 **CAUTION:** Clearing CMOS settings resets the BIOS settings on your computer.

## Steps

1. Remove the [Side cover](#).
2. Disconnect the battery cable from the system board.
3. Remove the [coin-cell battery](#).
4. Wait for one minute.
5. Replace the [coin-cell battery](#).
6. Connect the battery cable to the system board.
7. Replace the [side cover](#).

# Clearing system and setup passwords

## About this task

To clear the system or setup passwords, contact Dell technical support as described at [Contact Support](#).

 **NOTE:** For information about how to reset Windows or application passwords, see the documentation accompanying Windows or your application.

# Troubleshooting

## Dell SupportAssist Pre-boot System Performance Check diagnostics

### About this task

SupportAssist diagnostics (also known as system diagnostics) performs a complete check of your hardware. The Dell SupportAssist Pre-boot System Performance Check diagnostics is embedded within the BIOS and launched by the BIOS internally. The embedded system diagnostics provides options for particular devices or device groups allowing you to:

- Run tests automatically or in an interactive mode.
- Repeat the tests.
- Display or save test results.
- Run thorough tests to add more options and obtain details about any failed devices.
- View status messages that inform you when the tests are completed successfully.
- View error messages that inform you of problems encountered during testing.

**NOTE:** Some tests for specific devices require user interaction. Always ensure that you are present at the computer when the diagnostic tests are performed.

For more information, see the knowledge base article [000181163](#).

## Running the SupportAssist Pre-Boot System Performance Check

### Steps

1. Turn on your computer.
2. As the computer boots, press the F12 key.
3. On the boot menu screen, select **Diagnostics**.  
The diagnostic quick test begins.

**NOTE:** For more information about running the SupportAssist Pre-Boot System Performance Check on a specific device, see [Dell Support Site](#).

4. If there are any issues, error codes are displayed.  
Note the error code and validation number and contact Dell.

## Power-Supply Unit Built-in Self-Test

Built-in Self-Test (BIST) helps determine if the power-supply unit is working. To run self-test diagnostics on the power-supply unit of a desktop or all-in-one computer, search in the Knowledge Base Resource at [Dell Support Site](#).

## System-diagnostic lights

This section lists the system-diagnostic lights of your Dell Pro Max Slim FCS1250.

The following table shows different Service LED blinking patterns and associated problems. The diagnostic light codes consist of a two-digit number, and the digits are separated by a comma. The number stands for a blinking pattern; the first digit shows the number of blinks in amber color, and the second digit shows the number of blinks in white color. The Service LED blinks in the following manner:

- The Service LED blinks the number of times equal to the value of the first digit and turns off with a short pause.
- After that, the Service LED blinks the number of times equal to the value of the second digit.

- The Service LED turns off again with a longer pause.
- After the second pause, the blinking pattern will be repeated.

**Table 40. Diagnostic light codes**

Diagnostic light codes (Amber, White)	Problem description
1,1	TPM Detection Failure
1,2	Unrecoverable SPI Flash Failure
1,5	EC unable to program i-Fuse
1,6	Generic catch-all for ungraceful EC code flow errors
1,7	Non-RPMC Flash on Boot Guard fused system
1,8	Chipset "Catastrophic Error" signal has tripped
2,1	CPU configuration or CPU failure
2,2	System board: BIOS or Read-Only Memory (ROM) failure
2,3	No memory or Random-Access Memory (RAM) detected
2,4	Memory or Random-Access Memory (RAM) failure
2,5	Invalid memory installed
2,6	System board/Chipset Error
2,7	LCD failure SBIOS message
2,8	Display power-rail failure on the system board
3,1	CMOS battery failure
3,2	PCI of Video card/chip failure
3,3	Recovery image not found
3,4	Recovery image found but invalid
3,5	EC power-rail error
3,6	Flash corruption detected by SBIOS
3,7	Timeout waiting on ME to reply to HECI message
4,1	Memory DIMM power rail failure
4,2	CPU Power cable connection issue

## Recovering the operating system

When your computer is unable to boot to the operating system even after repeated attempts, it automatically starts Dell SupportAssist OS Recovery.

Dell SupportAssist OS Recovery is a stand-alone tool that is preinstalled in Dell computers running the Windows operating system. It consists of tools to diagnose and troubleshoot issues that may occur before your computer boots to the operating system. It enables you to diagnose hardware issues, repair your computer, back up your files, and restore your computer to its factory state.

You can also download it from the Dell Support website to troubleshoot and fix your computer when it fails to boot into the primary operating system due to software or hardware failures.

For more information about the Dell SupportAssist OS Recovery, see *Dell SupportAssist OS Recovery User's Guide* at [Serviceability Tools at the Dell Support Site](#). Click **SupportAssist** and then click **SupportAssist OS Recovery**.

 **NOTE:** Windows 11 IoT Enterprise LTSC 2024 and Dell ThinOS 10 do not support Dell SupportAssist. For more information about recovering ThinOS 10, see [Recovery mode using R-Key](#).

# Real-Time Clock—RTC reset

The Real-Time Clock (RTC) reset function allows you or the service technician to recover the recently launched model Dell Pro and Pro Max computers from **No POST/No Boot/No Power** situations. You can initiate the RTC reset on the computer from a power-off state only if it is connected to AC power. Press and hold the power button for 25 seconds. The system RTC reset occurs after you release the power button.

 **NOTE:** If AC power is disconnected from the computer during the process or the power button is held longer than 40 seconds, the RTC reset process gets aborted.

The RTC reset will reset the BIOS to its default settings, disable Intel vPro, and reset the computer date and time. The following items are not affected by the RTC reset:

- Service Tag
- Asset Tag
- Ownership Tag
- Admin Password
- System Password
- Storage Password
- Key Databases
- System Logs

 **NOTE:** The IT administrator's vPro account and password on the computer will be unprovisioned. The computer must go through the setup and configuration process again to reconnect it to the vPro server.

The below items may or may not be reset based on your custom BIOS setting selections:

- Boot List
- Enable Legacy Option ROMs
- Secure Boot Enable
- Allow BIOS Downgrade

## Backup media and recovery options

It is recommended to create a recovery drive to troubleshoot and fix problems that may occur with Windows. Dell provides multiple options for recovering the Windows operating system on your Dell computer. For more information, see [Dell Windows Backup Media and Recovery Options](#).

## Network power cycle

### About this task

If your computer is unable to access the Internet due to network connectivity issues, reset your network devices by performing the following steps:

### Steps

1. Turn off the computer.
2. Turn off the modem.

 **NOTE:** Some Internet service providers (ISPs) provide a modem and router combo device.

3. Turn off the wireless router.
4. Wait for 30 seconds.
5. Turn on the wireless router.
6. Turn on the modem.
7. Turn on the computer.

# Getting help and contacting Dell

## Self-help resources

You can get information and help on Dell products and services using these self-help resources:

**Table 41. Self-help resources**

Self-help resources	Resource location
Information about Dell products and services	<a href="#">Dell Site</a>
Tips	
Contact Support	In Windows search, type <code>Contact Support</code> , and press Enter.
Online help for operating system	<a href="#">Windows Support Site</a> <a href="#">Linux Support Site</a>
Access top solutions, diagnostics, drivers and downloads, and learn more about your computer through videos, manuals, and documents.	Your Dell computer is uniquely identified using a Service Tag or Express Service Code. To view relevant support resources for your Dell computer, enter the Service Tag or Express Service Code at <a href="#">Dell Support Site</a> .  For more information about how to find the Service Tag for your computer, see <a href="#">Locate the Service Tag on your computer</a> .
Dell knowledge base articles	<ol style="list-style-type: none"> <li>1. Go to <a href="#">Dell Support Site</a>.</li> <li>2. On the menu bar at the top of the Support page, select <b>Support &gt; Support Library</b>.</li> <li>3. In the Search field on the Support Library page, type the keyword, topic, or model number, and then click or tap the search icon to view the related articles.</li> </ol>

## Contacting Dell

To contact Dell for sales, technical support, or customer service issues, see [Dell Support Site](#).

 **NOTE:** Availability of the services may vary depending on the country or region, and product.

 **NOTE:** If you do not have an active Internet connection, you can find contact information in your purchase invoice, packing slip, bill, or Dell product catalog.